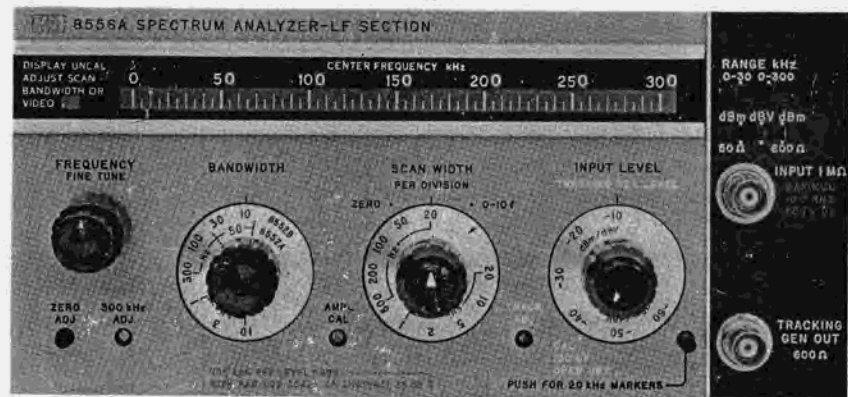


OPERATION AND SERVICE MANUAL

8556A SPECTRUM ANALYZER LF SECTION



**HEWLETT
PACKARD**

MODEL 8556A



ACCESSORIES

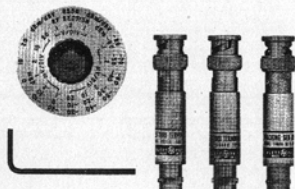


Figure 1-1. Model 8556A Spectrum Analyzer LF Section with 8552B IF Section and 141T Display Section

SECTION I GENERAL INFORMATION

1-1. INTRODUCTION

1-2. This manual contains all information required to install, operate, test, adjust and service the Hewlett-Packard Model 8556A Spectrum Analyzer LF Section. This section covers instrument identification, description, options, accessories, specifications and other basic information.

1-3. Figure 1-1 shows the Hewlett-Packard Model 8556A Spectrum Analyzer LF Section with the Model 8552B Spectrum Analyzer IF Section and the Model 141T Display Section. Also shown are the accessories supplied with the 8556A (see paragraph 1-15).

1-4. The various sections in this manual provide information as follows:

SECTION II, INSTALLATION, provides information relative to incoming inspection, power requirements, mounting, packing, shipping, etc.

SECTION III, OPERATION, provides information relative to operating the instrument.

SECTION IV, PERFORMANCE TESTS, provides information required to ascertain that the instrument is performing in accordance with published specifications.

SECTION V, ADJUSTMENTS, provides information required to properly adjust and align the instrument after repairs are made.

SECTION VI, REPLACEABLE PARTS, provides ordering information for all replaceable parts and assemblies.

SECTION VII, MANUAL CHANGES, normally will contain no relevant information in the original issue of a manual. This section is reserved to provide back-dating and up-dating information in manual revisions or reprints.

SECTION VIII, SERVICE, includes all information required to repair the instrument.

1-5. INSTRUMENTS COVERED BY MANUAL

1-6. Hewlett-Packard instruments carry a serial number (see Figure 1-2) on the back panel. When the serial number prefix on the instrument serial number plate of your instrument is the same as one

of the prefix numbers on the inside title page of this manual, the manual applies directly to the instrument. When the instrument serial number prefix is not listed on the inside title page of this manual, manual change sheets and manual updating information is provided. Later editions or revisions to the manual will contain the required change information in Section VII.

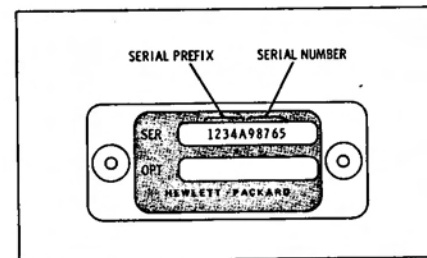


Figure 1-2. Instrument Identification

1-7. DESCRIPTION

1-8. The Hewlett-Packard Model 8556A Spectrum Analyzer LF Section covers the frequency range from 20 Hz to 300 kHz. When it is combined with an IF Section and a Display Section it functions as the tuning section of a low frequency spectrum analyzer.

1-9. The analyzer electronically scans input signals and displays their frequency and amplitude on a CRT. The horizontal, x-axis, is calibrated in units of frequency and the vertical, y-axis, is calibrated in absolute units of voltage (μV , mV, dBV) or power (dBm). Therefore, absolute and relative measurements of both amplitude and frequency can be made.

1-10. The horizontal (frequency) axis can be swept three different ways:

a. The center of the CRT is set to a frequency determined by the dial and the analyzer is swept symmetrically about that frequency.

b. The analyzer is not swept but is used as a fixed frequency receiver. Signal amplitude can be read on the CRT and signal modulation can be viewed as with an oscilloscope.

Table 1-5. Test Equipment Accessories (cont'd)

Item	Required Features	Suggested Model	Use*
Service Kit (cont'd)	Selectro Female to Selectro Female Test Cable, 2 each, 8 inches long (HP 11592-60002) Extender Board Assembly, 15 pins, 30 conductors, for plug-in circuit boards (HP 11592-60011) Fastener Assembly (2 each: HP 11592-2001 and HP 1390-0170) Selectro Jack-to-Jack Adapter (HP 1250-0827) Wrench, open end, 15/16 inch (HP 8710-0946) BNC Jack-to-OSM Plug Adapter (HP 1250-1200) OSM Plug-to-Plug Adapter (HP 1250-1158) Cable Assembly R and P Connector (HP 11592-60013)	HP 11592A	A, T
*Use: Performance = P; Adjustment = A; Troubleshooting = T.			

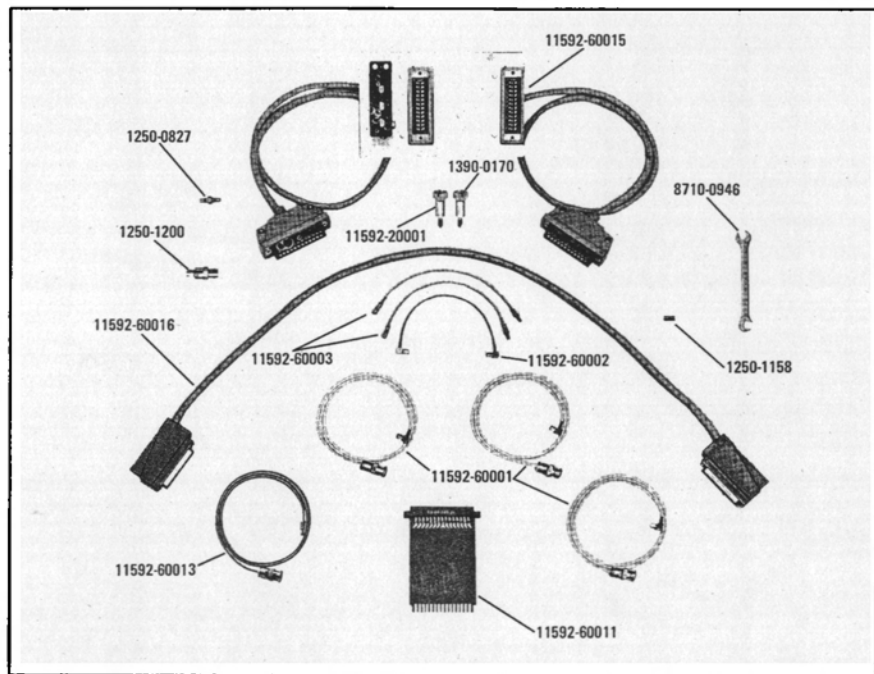


Figure 1-5. HP 11592A Service Kit

SECTION II INSTALLATION

2-1. INITIAL INSPECTION

2-2. Mechanical Check

2-3. Check the shipping carton for evidence of damage immediately after receipt. If there is any visible damage to the carton, request the carrier's agent be present when the instrument is unpacked. Inspect the instrument for physical damage such as bent or broken parts and dents or scratches. If damage is found refer to paragraph 2-6 for recommended claim procedures. If the instrument appears to be undamaged, perform the electrical check (see paragraph 2-4). The packaging material should be retained for possible future use.

2-4. Electrical Check

2-5. The electrical check consists of following the performance test procedures listed in Section IV. These procedures allow the operator to determine that the instrument is, or is not, operating within the specifications listed in Table 1-1. The initial performance and accuracy of the instrument are certified as stated on the inside front cover of this manual. If the instrument does not operate as specified, refer to paragraph 2-6 for the recommended claim procedure.

2-6. CLAIMS FOR DAMAGE

2-7. If physical damage is found when the instrument is unpacked, notify the carrier and the nearest Hewlett-Packard Sales and Service Office immediately. The Sales and Service Office will arrange for repair or replacement without waiting for a claim to be settled with the carrier.

2-8. The warranty statement for the instrument is on the inside front cover of this manual. Contact the Sales and Service Office for information about warranty claims.

2-9. PREPARATION FOR USE

CAUTION

Before applying power, check the rear panel slide switch on the Display Section for proper position (115 or 230 volts).

2-10. Shipping Configuration

2-11. Because of individual customer requirements, shipping configurations are flexible. Preparation for use is based on the premise that the

LF and IF Sections are installed in a Display Section; thus, the Spectrum Analyzer is physically and functionally complete for use. Since the LF and IF Sections are usually received separately, the plug-ins must be mechanically fitted together, electrically connected and inserted in a display section or oscilloscope mainframe of the 140-series. For mechanical and electrical connections, refer to Figure 2-1 and paragraph 2-20.

2-12. Power Requirements

2-13. The Spectrum Analyzer can be operated from a 50 to 60 hertz input line that supplies either a 115 volt or 230 volt ($\pm 10\%$ in each case) power. Consumed power varies with the plug-ins used but is normally less than 225 watts. Line power enters the Display Section or Mainframe, where it is converted to dc voltages, and then is distributed to the LF and IF Sections via internal connectors.

2-14. The 115/230 power selector switch at the rear of the Display Section must be set to agree with the available line voltage. If the line voltage is 115 volts, the slide switch must be positioned so that 115 is clearly visible. The instrument is internally fused for 115 volt operation, when shipped. If 230 volt source is to be used, refer to fuse replacement procedures in the Display Section manual.

2-15. Power Cable

2-16. To protect operating personnel, the National Electrical Manufacturers Association (NEMA) and the International Electrotechnical Commission (IEC) recommends that the instrument panel and cabinet be grounded. The Spectrum Analyzer is equipped with a three-conductor power cable; the third conductor is the ground conductor, and when the cable is plugged into an appropriate receptacle, the instrument is grounded. To preserve the protection feature when operating the instrument from a two-contact outlet, use a three-prong to two-prong adapter and connect the green lead on the adapter to ground.

2-17. Operating Environment

2-18. The Spectrum Analyzer uses a forced-air cooling system to maintain required operating temperatures within the instrument. The air intake and filter are located on the rear of the Display Section; air is exhausted through the side panel

c. The analyzer is swept from 0 Hz to a higher frequency — selectable from 200 Hz to 200 kHz.

1-11. The vertical (amplitude) axis provides relative and absolute measurement capability in volts, dBV, dBm into 600 ohms unbalanced, and dBm into 50 ohms.

1-12. The LF Section's input is isolated from the instrument chassis so that the CRT display is free of line frequency spurious responses due to ground loops.

1-13. Accurate frequency calibration is provided by selecting 20 kHz markers.

1-14. The LF Section also contains a tracking generator that produces a calibrated signal that precisely tracks the analyzer tuning frequency. This signal can be used to test the frequency response of a device; it can also be used, with a frequency counter, for making frequency measurements that are accurate to 1 Hz (see Section III).

1-15. ACCESSORIES SUPPLIED

1-16. The 8556A LF Section requires a special knob on the IF Section in place of the standard LOG REF LEVEL control. The special knob has three scales: one is used for the LF Section log calibrator (red scale), one for log calibration with the RF Sections (black scale), and one for linear calibration with all units (blue scale). This knob and an allen wrench to install it are supplied with each 8556A. Extra knobs (HP 08556-00013) are available from the nearest HP Sales and Service Office.

1-17. The 8556A is supplied with the following accessories:

HP 11905A 600 ohm Feed Thru Termination
HP 11048B 50 ohm Feed Thru Termination
HP 11660A Tracking Generator Shunt (50 ohm output)

1-18. EQUIPMENT REQUIRED BUT NOT SUPPLIED

1-19. The 8556A LF Section must be mated with an IF Section, such as the 8552A or the 8552B, and a Display Section, such as the 140T or the 141T, before the units can perform as a spectrum analyzer.

1-20. IF Sections

1-21. The 8552A IF Section features calibrated bandwidths, log and linear amplitude calibration, and calibrated scan times. The 8552B IF Section

has all of the features of the 8552A and, in addition, manual scan, greater frequency stability, narrower bandwidths and an expanded log scale (2 dB per division).

1-22. Display Sections

1-23. The 140T Display Section is equipped with a fixed persistence, non-storage CRT; the 141T Display Section is equipped with a variable persistence, storage CRT. The 143S Display Section has a large screen (8x10 inch) CRT.

1-24. COMPATIBILITY

1-25. The 8556A LF Section is fully compatible with all current 8552A/B IF Sections; 8552A's with serial prefix 991 and below, and 8552B's with serial prefix 977 and below must be modified. The modification consists of adding a white-blue-grey (24 AWG) wire between 8552A/B connectors XA8 pin 8 and J3 pin 40. (See appropriate 8552 manual for location of connectors.)

NOTE

The 8556A requires a special knob on the IF Section in place of the standard LOG REF LEVEL control (see EQUIPMENT SUPPLIED).

1-26. The 8556A LF Section is fully compatible with all HP 140S/T, HP 141S/T, and HP 143S Display Sections. The 8556A can be used with HP 140A/B and 141A/B Oscilloscope Mainframes but some performance specifications will be slightly degraded. (For more information, contact your nearest Hewlett-Packard office.)

1-27. OPERATING ACCESSORIES

1-28. Operating accessories for use with the 8556A/8552/140 Spectrum Analyzer are listed in Table 1-3. They include a frequency counter, an oscilloscope camera, and various attenuators and probes.

1-29. TEST EQUIPMENT REQUIRED

1-30. Tables 1-4 and 1-5 list the test equipment and test equipment accessories required to check, adjust and repair the 8556A LF Section.

1-31. WARRANTY

1-32. The 8556A LF Section is warranted and certified as indicated on the inner front cover of this manual. For further information contact the nearest Hewlett-Packard Sales and Service Office; addresses are provided at the back of this manual.

Table 1-1. Specifications

8556A/8552B/8552A	
FREQUENCY	
Range: 20 Hz to 300 kHz — 8552B IF Section 100 Hz to 300 kHz — 8552A IF Section	Stability: Residual FM: With 8552B IF Section: Sidebands >60 dB down 50 Hz or more from CW signal, scan time ≥ 1 sec/div, 10 Hz bandwidth. With 8552A IF Section: Less than 20 Hz peak-to-peak. Noise Sidebands: More than 90 dB below CW signal, 3 kHz away from signal, with a 100 Hz IF bandwidth.
Tuning Dial Ranges of 0–30 kHz and 0–300 kHz.	
Scan Width: (On a 10 div. CRT horizontal axis.) Per Division: 10 calibrated scan widths from 20 Hz/div to 20 kHz/div in a 1, 2, 5 sequence. 0–10f: 10 calibrated preset scans, from 200 Hz to 200 kHz in a 1, 2, 5 sequence. Analyzer scans from zero frequency to ten times the scan width per division setting. Zero: Analyzer is a fixed tuned receiver.	Frequency Drift: (After 1 hour warmup.) With 8552B IF Section: Less than 200 Hz/10 min. With 8552A IF Section: Less than 1 kHz /10 min.
Accuracy: Center Frequency: After 1 hour warmup, zero and 300 kHz adjustments, and with the Fine Tune centered, the dial indicates the display center frequency within the following specifications: With 8552B IF Section: 0–30 kHz Range: ± 500 Hz 0–300 kHz Range: ± 3 kHz With 8552A IF Section: 0–30 kHz Range: ± 1 kHz 0–300 kHz Range: ± 5 kHz	Resolution: Bandwidth Ranges: IF bandwidths of 10 Hz (50 Hz for 8552A) to 10 kHz are provided in a 1, 3, 10 sequence. Bandwidth Accuracy: Individual IF bandwidth 3 dB points calibrated to $\pm 20\%$ (10 kHz bandwidth $\pm 5\%$). Bandwidth Selectivity: 60 dB/3 dB IF bandwidth ratios. With 8552B IF Section: <11:1 for IF bandwidths from 10 Hz to 3 kHz; <20:1 for 10 kHz IF bandwidth. For 10 Hz bandwidth, 60 dB points are separated by less than 100 Hz.
Marker: RF markers every 20 kHz accurate to within $\pm 0.01\%$. Markers controlled by front panel on/off switch.	
Scan Width: With 8552B IF Section: Frequency error between any two points on the display is less than $\pm 3\%$ of the indicated frequency separation. With 8552A IF Section: Frequency error between any two points on the display is less than $\pm 5\%$ of the indicated frequency separation.	With 8552A IF Section: <25:1 for IF bandwidths from 50 Hz to 300 kHz; <20:1 for IF bandwidths from 1 kHz to 10 kHz.

Table 1-1. Specifications (cont'd)

AMPLITUDE

Absolute Amplitude Calibration Range:

Log Modes:

dBV	0 dBV = 1 V rms
dBm-600Ω	0 dBm = 1 mW - 600Ω
dBm-50Ω	0 dBm = 1 mW - 50Ω

Input impedance is 1 MΩ. dBm ranges are referenced with input properly terminated externally.

Log Range: From -150 dBm/dBV to +10 dBm/dBV in 10 dB steps. Log reference level vernier, 0 to -12 dB continuously.

Log Display Range: 10 dB/div on a 70 dB display, or 2 dB/div on a 16 dB display (with 8552B only).

Linear Sensitivity: From 0.1 μV/div to 1V/div in a 1, 2, 10 sequence. Linear sensitivity vernier X1 to X0.25 continuously.

Dynamic Range:

Average Noise Level: Specified with a 600Ω or less source impedance and INPUT LEVEL at -60 dBm/dBV.

Mode	1 kHz IF Bandwidth		10 Hz IF Bandwidth	
	dBm-50 Ω	<122 dBm (180 nV)	<142 dBm (18 nV)	<150 dBm (25 nV)
dBm-600Ω	<130 dBm (250 nV)	<150 dBm (25 nV)	<132 dBV (250 nV)	<152 dBV (25 nV)
Linear	<400 nV	<40 nV		

Spurious Responses: Input signal level ≤ INPUT LEVEL Setting: out of band mixing responses,

harmonic and intermodulation distortion products are all more than 70 dB below the input signal level 5 kHz to 300 kHz; 60 dB 20 Hz to 5 kHz. Third order intermodulation products are more than 70 dB below the input signal level, 5 kHz to 300 kHz with signal separation >300 Hz.

Residual Responses: (no signal present at input): with the INPUT LEVEL at -60 dBm/dBV and the input terminated with 600Ω or less, all line related residual responses from 0-500 Hz are below -120 dBm/dBV. All other residual responses are below -130 dBm/dBV.

Gain Compression: For input signal level 20 dB above INPUT LEVEL setting gain compression is less than 1 dB.

INPUT LEVEL Control: -10 to -60 dBm/dBV in 10 dB steps. Accuracy ±0.2 dB. Marking indicates maximum input levels for 70 dB spurious-free dynamic range.

Accuracy:	Log	Linear
Frequency Response:	±0.2 dB	±2.3%
Switching Between Bandwidths (at 20°C),		
100 Hz to 10 kHz:	±0.5 dB	±5.8%
20 Hz to 10 kHz:	±1.0 dB	±12%
10 Hz to 10 kHz:	±1.5 dB	±20%
Display:	±2.5 dB/dB	±2.8% of full but not more than ±1.5 dB over 70 dB display range

TRACKING GENERATOR

Frequency Range: Tracks the analyzer tuning, 20 Hz to 300 kHz.

Amplitude Range: Continuously variable from 100 mV rms to greater than 3V rms into an open circuit.

Amplitude Accuracy: With TRACKING GEN LEVEL in CAL position, output level at 100 kHz is 100 mV ±0.3 dB into an open circuit.

Frequency Response: ±0.25 dB 50 Hz to 300 kHz.

Output Impedance: 600Ω.

Spectral Purity:

Residual FM:
With 8552B IF Section: <1 Hz peak-to-peak.
With 8552A IF Section: <20 Hz peak-to-peak.

Harmonic Signals: >40 dB down.

Spurious Outputs: >50 dB down.

Table 1-1. Specifications (cont'd)

INPUT

Input Impedance: 1 MΩ shunted by ≈ 32 pF.

Maximum Input Level: 10V rms, ±200 Vdc.

Ground terminals of BNC input connectors are isolated from the analyzer chassis ground to minimize ground loop pickup at low frequencies.

Maximum Voltage, Isolated Ground to Chassis Ground: ±100 Vdc.

Isolated Ground to Chassis Ground Impedance: 100 kΩ shunted by approximately 0.3 μf.

GENERAL

Scan Time: 16 internal scan rates from 0.1 ms/div to 10 sec/div in a 1, 2, 5 sequence.

Scan Time Accuracy:
0.1 ms/div to 20 ms/div: ±10%
50 ms/div to 10 sec/div: ±20%.

Power Requirements: 115 or 230 volts ±10%, 50 to 60 Hz, less than 225 watts.

Dimensions:

Model 140T or 141T Display Section: 9-1/5" high (including height of feet) x 16-3/4" wide x 18-3/8" deep (229 x 425 x 467 mm).

Model 143S Display Section: 21" high (including height of feet) x 16-3/4" wide x 18-3/8" deep (533 x 425 x 467 mm).

Weight:

Model 8556A LF Section: Net, 8 lb (3,7 kg).

Model 8552B IF Section: Net, 9 lb (4,1 kg).

Model 8552A IF Section: Net, 9 lb (4,1 kg).

Model 140T Normal Persistence Display Section: Net 37 lb (16,8 kg).

Model 141T Variable Persistence Display Section: Net, 40 lb (18 kg).

Model 143S Large Screen Display Section: Net 62 lb (28,1 kg).

Accessories Included:

Model 11660A Tracking Generator Shunt

Model 11048B 50Ω Feed Thru Termination

Model 11095A 600Ω Feed Thru Termination

Table 1-2. Supplemental Performance Characteristics

FREQUENCY CHARACTERISTICS

Range: With 300 kHz Center Frequency and 20 kHz/div Scan Width, analyzer will scan linearly to 400 kHz.

Center Frequency Control: Approximately 10 turns to cover full dial indicator in both 0-30 kHz and 0-300 kHz ranges.

Fine Tune: Single turn control, ± 50 Hz on 0-30 kHz range, ± 500 Hz on 0-300 kHz range.

Zero Adjust: ± 27 kHz range with 8552A, ± 12 kHz range with 8552B.

0-10f Scan Mode: With zero properly adjusted in PER DIVISION scan, 0 to 10f scan mode will scan from 0 (± 500 Hz or 0.2 div, whichever is greater) to ten times the scan width per division setting. Offset may be reduced to 0 readjusting frequency zero. Scan accuracy $\pm 5\%$.

Resolution: See Figure 1-3 for curves of typical 8556A/8552B/8552A Spectrum Analyzer resolution using different IF bandwidths.

Warmup Drift: (Typical - first hour's operation.)

With 8552B: 500 Hz
With 8552A: 15 kHz

Long Term Drift: (Typical - at fixed center frequency after one hour warmup.)

With 8552B: 70 Hz/10 min
With 8552A: 400 Hz/10 min

Temperature Drift: (Typical.)

With 8552B: 200 Hz/ $^{\circ}$ C
With 8552A: 2 kHz/ $^{\circ}$ C

AMPLITUDE CHARACTERISTICS

Dynamic Range: For operation from 5 kHz to 300 kHz with signal levels greater than INPUT LEVEL setting, see Figure 1-4 for typical distortion.

Accuracy:

Log Reference Level: INPUT LEVEL and LOG REF LEVEL controls provide continuous log reference levels from +10 dBm/dBV to -80 dBm/dBV (may be decreased to -92 dBm/dBV by using 12 dB Log Reference Level Vernier).

Input Level: Provides 50 dB control of input preamplification and attenuation to prevent input overload. INPUT LEVEL markings of -60 dBm/dBV to -10 dBm/dBV indicate maximum input level for a minimum of 70 dB spurious

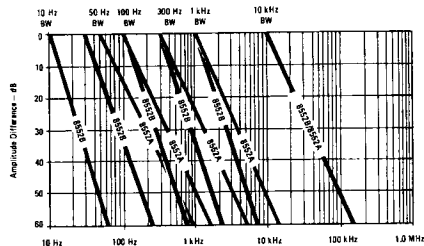
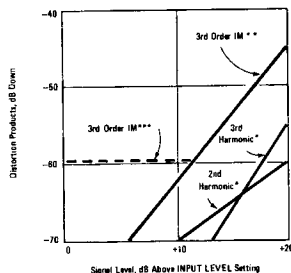


Figure 1-3. Typical Spectrum Analyzer Resolution



- * Single input signal, 300 Hz to 300 kHz. Second and third harmonic distortion products typically 10 dB higher below 30 Hz.
- ** Two input signals, 5 kHz to 300 kHz with > 300 Hz signal separation.
- *** Two input signals, frequency below 5 kHz with < 300 Hz signal separation.

Figure 1-4. Typical Spectrum Analyzer Distortion Products

Table 1-2. Supplemental Performance Characteristics (cont'd)

AMPLITUDE CHARACTERISTICS (cont'd)

free dynamic range. Accuracy ± 0.2 dB (2.3%). Input may be overloaded up to 20 dB with the analyzer still providing useful measurement capability. See Figure 1-4.

Accuracy: ± 0.6 dB
Temperature Stability: ± 0.07 dB/ $^{\circ}$ C.

Log Reference Level Control: Provides 90 dB of IF gain control in 10 dB steps to cover log and linear ranges. Accurate to ± 0.2 dB ($\pm 2.3\%$).

Amplitude Stability: ± 0.07 dB/ $^{\circ}$ C in log, $\pm 0.6\%$ / $^{\circ}$ C in linear.

Log Reference Level Vernier: Provides continuous 12 dB range. Accurate to ± 0.1 dB ($\pm 1.2\%$) in 0, -6, -12 dB positions; otherwise ± 0.25 dB ($\pm 2.8\%$).

Display Uncalibrated Light: Warns if a combination of control settings (IF or video bandwidth, scan time or scan width) degrades absolute calibration for CW signals. Typically accurate to ± 1 position in scan width or scan time setting.

Log Reference Level, switching between 10 dB/div and 2 dB/div log scales (8552B only):

Video Filter: Averages displayed noise; bandwidth of 10 kHz, 100 Hz and (8552B only) 10 Hz. Bandwidth accuracy $\pm 20\%$.

DISPLAY CHARACTERISTICS

Variable Persistence/Storage (Model 141T):

Plug-ins: Accepts Model 8550 series Spectrum Analyzer plug-ins and Model 1400 series time domain plug-ins.

Fast Writing Speed: More than 15 minutes (typically 30 minutes) at reduced brightness or more than 15 seconds at maximum brightness.

Functions Used with Time Domain Plug-ins Only: Intensity modulation, calibrator, beam finder.

Cathode-ray Tube:

Type: Post-accelerator storage tube, 9000 volt accelerating potential; aluminumized P31 phosphor; etched safety glass face-plate reduces glare.

Normal Persistence (Model 140T):

Plug-ins: Same as 141T.

Cathode-ray Tube:

Type: Post-accelerator, 7300 volt potential medium-short persistence (P7) phosphor, tinted and etched safety glass face-plate reduces glare. (Normal persistence of P7 phosphor approximately 3 sec.)

Graticule: 8 x 10 division (approximately 7.1 x 8.9 cm) parallax-free internal graticule; five subdivisions per major division on horizontal and vertical axes.

Graticule: 8 x 10 division (approximately 7.6 x 9.5 cm) parallax-free internal graticule; five subdivisions per major division on horizontal and vertical axes.

Persistence:

Normal: Natural persistence of P31 phosphor (approximately 0.1 second).

Functions Used with Time Domain Plug-ins Only: Same as 141T.

Variable:

Normal Writing Rate Mode: Continuously variable from less than 0.2 second to more than one minute (typically to two or three minutes).

Maximum Writing Rate Mode: Typically from 0.2 second to 15 seconds.

Erase: Manual; erasure takes approximately 350 ms; CRT ready to record immediately after erasure.

Normal Persistence Large Screen Display (Model 143S):

Plug-ins: Same as 141T.

Cathode Ray Tube:

Type: Post-accelerator, 20 kV accelerating potential aluminumized P31 phosphor. (Persistence approximately 0.1 sec.)

Graticule: 8 x 10 divisions (approximately 8 x 10-inch) parallax-free internal graticule, five subdivisions per major division on horizontal and vertical axes.

Storage Time: Normal writing rate; more than 2 hours at reduced brightness (typically 4 hours). More than one minute at maximum brightness.

Functions Used with Time Domain Plug-ins Only: Same as 141T.

Table 1-2. Supplemental Performance Characteristics (cont'd)

GENERAL CHARACTERISTICS

Scan Mode:

Int: Analyzer repetitively scanned by internally generated ramp; synchronization selected by scan trigger.

Single: Single scan with reset actuated by front panel pushbutton.

Ext: Scan determined by 0 to +8 volt external signal; scan input impedance more than 10 k Ω .

Blanking: -1.5V external blanking signal required.

Manual: Scan determined by front panel control; continuously variable across CRT in either direction (8552B only).

Scan Trigger: For Internal Scan Mode, select between:

Auto: Scan free runs.

Line: Scan synchronized with power line frequency.

Ext: Scan synchronized with more than 2 volt (20 volt max.) trigger signal (polarity selected by internally located switch in Model 8552 IF Section).

Video: Scan internally synchronized to envelope of RF input signal (signal amplitude of 1.5 major divisions peak-to-peak required on display section CRT).

Auxiliary Outputs:

Vertical Output: Approximately 0 to -0.8V for 8 division deflection on CRT display; approximately 100 Ω output impedance.

Scan Output: Approximately -5 to +5V for 10 div CRT deflection, 5k Ω output impedance.

Pen Lift Output: 0 to 14V (0V, pen down). Output available in Int and Single Scan modes and Auto, Line, and Video Scan Trigger.

CRT Baseline Clipper: Front panel control adjusts blanking of CRT trace baseline to allow more detailed analysis of low repetition rate signals and improved photographic records to be made.

EMI: Conducted and radiated interference is within requirements of MIL-I-16910C and MIL-I-6181D and methods CE03 and RE02 of MIL-STD-461 (except 35 to 40 kHz) when 8556A and 8552B are combined in a 140T or 141T Display Section.

Temperature Range: Operating, 0°C to +55°C, storage, -40°C to +75°C.

Table 1-3. Operating Accessories

Model Number	Description
HP 10004A	10:1 Divider Probe (oscilloscope type)
HP 1001A	Probe to BNC Adapter
HP 1110A	Current Probe: Sensitivity: 1 mV/mA Bandwidth: 1700 Hz (3 dB down) 30 MHz (3 dB down)
HP 5221B	Electronic Counter, Option 001 Frequency Range: 5 Hz to 10 MHz Sensitivity: 100 mV rms max Gate Time: .01, 0.1, 1 and 10 sec. Accuracy: $\pm 0.001\%$ ± 1 count Readout: 6 digits
HP 4437A	600 ohm Unbalanced Attenuator Range: 0-119.9 dB in 0.1 dB increments Accuracy: ± 0.2 dB to 90 dB ± 0.5 dB to 110 dB ± 1.0 dB to 119.9 dB Input Power: 1 watt max
HP 197A	Oscilloscope Camera

Table 1-4. Test Equipment

Item	Minimum Specifications	Suggested Model	Use*
AC Voltmeter	Voltage Range: 1 mV to 10V full scale (-10 to +2 dB on dB scale) Frequency Range: 20 Hz to 400 kHz Accuracy: \pm (2.5% of full scale +2.5% of reading) AC to DC Converter Output: 1V dc for full scale meter deflection AC to DC Converter Accuracy: \pm (1% of full scale +1% of reading) Input Impedance: 10 M Ω shunted by \approx 25 pF	HP 400EL	P, A, T
Oscilloscope	Frequency Range: dc to 50 MHz AC or DC Coupling Sensitivity: 0.005 V/DIV Voltage Accuracy: $\pm 3\%$	HP 180A/ 1801A/ 1820B	A, T
X10 Oscilloscope Probe (2)	Resistance: 10 M Ω shunted by \approx 10 pF Division Accuracy: 3%	HP 10004A	A, T
*Use: Performance = P; Adjustment = A; Troubleshooting = T			

perforations. When operating the instrument, choose a location which provides at least three inches of clearance around the rear and both sides. Refer to the Display Section manual for maintenance instructions for the cooling system.

2-19. Interconnections

2-20. The LF and IF Sections are normally shipped separately; the plug-ins must be mechanically fitted together, electrically connected, and then inserted in the Display Section or mainframe. To make these connections, refer to Figure 2-1 and proceed as follows:

a. Set the IF Section on a level bench. Locate slot near right rear corner of LF Section; also, locate metal tab on IF Section that engages with this slot.

b. Grasp the 8556A LF Section near middle of chassis and raise until it is a few inches above the IF Section.

c. Tilt LF Section until front of assembly is about 2 inches higher than the rear.

d. Engage assemblies in such a way that metal tab on the rear of the IF Section slips through the slot on LF Section.

e. With the preceding mechanical interface completed, gently lower LF Section until electrical plug and receptacle meet.

f. Position LF Section as required to mate the plug and receptacle. When plug and receptacle are properly aligned, only a small downward pressure is required to obtain a snug fit.

g. After the LF and IF Sections are joined mechanically and electrically, the complete assembly is ready to insert in the Display Section.

h. Pick up the LF/IF Sections and center in opening of Display Section. Push forward until assembly fits snugly into Display Section.

i. Push in front panel latch to securely fasten assembly in place.

2-21. To separate the LF/IF Sections from Display Section and to separate the LF Section from the IF Section, proceed as follows:

a. Push front panel latch in direction of arrow until it releases.

b. Firmly grasp the middle of latch flange and pull LF/RF Sections straight out.

c. Locate black press-to-release level near right front side of LF Section. Press this lever and simultaneously exert an upward pulling force on front edge of LF Section.

d. When the two sections separate at the front, raise LF Section two or three inches and slide metal tab at rear of IF Section out of the slot in which it is engaged.

2-22. STORAGE AND SHIPMENT

2-23. Original Packaging

2-24. The same containers and materials used in factory packaging can be obtained through the Hewlett-Packard Sales and Service Offices listed at the rear of this manual.

2-25. If the instrument is being returned to Hewlett-Packard for servicing, attach a tag indicating service required, return address, instrument model number and full serial number. Mark the container FRAGILE to assure careful handling.

2-26. In any correspondence refer to the instrument by model number and full serial number.

2-27. Other Packaging Materials

2-28. The following general instructions should be followed when repackaging with commercially available materials:

a. Wrap the instrument in heavy paper or plastic. (If shipping to a Hewlett-Packard Service Office or Center attach a tag indicating the type of service required, return address, model number and full serial number.)

b. Use a strong shipping container. A double wall carton made of 350 pound test material is adequate.

c. Use enough shock-absorbing material (three- to four-inch layer) around all sides of the instrument to provide firm cushion and prevent movement inside the container. Protect the control panel with cardboard.

d. Seal the shipping container securely.

e. Mark the shipping container FRAGILE to assure careful handling.

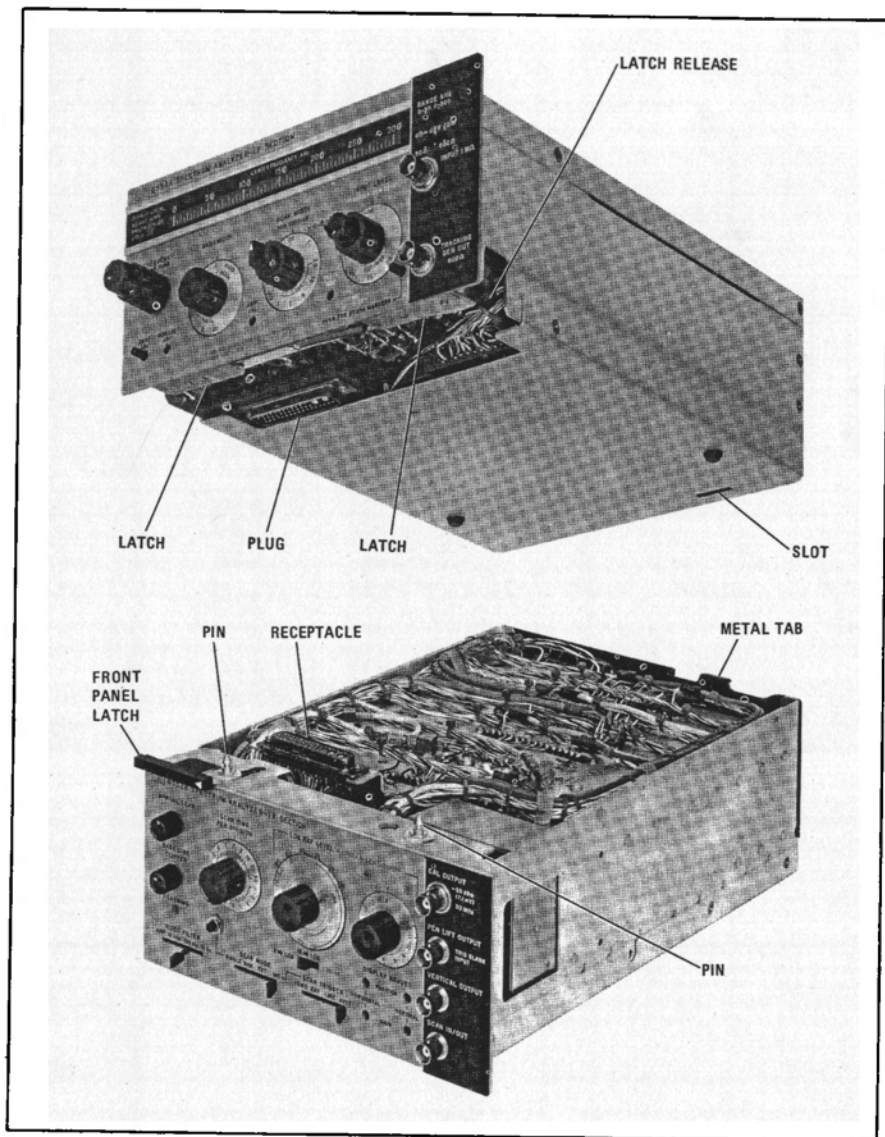


Figure 2-1. LF Section and IF Section Interconnections

SECTION III OPERATION

3-1. INTRODUCTION

3-2. This section provides complete operating instructions for the HP 8556A Spectrum Analyzer LF Section as used with an 8552 series IF Section and a 140 series Display Section.

3-3. PANEL FEATURES

3-4. Front panel controls, indicators and connectors are shown and briefly described in Figure 3-1. Rear panel controls and connectors are shown and described in Figure 3-2. For a detailed description of IF Section and Display Section controls and indicators, refer to their manuals.

3-5. OPERATOR'S CHECKS

3-6. Upon receipt of the analyzer, or when any plug-in is changed, perform the operational adjustments listed in Figure 3-2. This procedure corrects for minor differences between units and ensures that the LF Section, IF Section and Display Section are properly matched.

3-7. OPERATING CONSIDERATIONS

3-8. Front panel controls, indicators and connectors are shown and briefly described in Figure 3-1. The following information covers general operating considerations.

3-9. RF Input

3-10. The 8556A has an input impedance of 1 Megohm, shunted by approximately 32 pF, so compensated oscilloscope probes (see Table 1-3) can be connected directly to INPUT and used for in-circuit testing. To compensate an oscilloscope probe for use with the 8556A, use the probe's BNC adaptor to connect the probe tip to TRACKING GEN OUT. Adjust the probe for optimum signal flatness on the CRT display.

3-11. Use the feedthrough terminations, 50 ohm and 600 ohm, when the device to be tested must be terminated in its characteristic impedance (for example, when measuring dBm). To make a feedthrough termination for some other impedance, simply connect a resistor across the analyzer INPUT (connect the resistor to INPUT ground, not chassis ground). The value of the resistor should be equal to the characteristic impedance of the device.

CAUTION

Do not apply more than 10 V rms and ± 200 Vdc to INPUT.

3-12. Amplitude Ranges

3-13. The LOG/LINEAR switch on the IF Section works in conjunction with the dBm/dBV switch on the LF Section. With LINEAR selected, the analyzer measures voltage. With LOG selected (either 2 dB or 10 dB on the 8552B), the analyzer measures voltage in dBV (that is, dB referenced to 1 volt) or power in dBm. The LF Section is calibrated to measure dBm in 50 or 600 ohms.

3-14. To use 2 dB LOG, first find the signal using 10 dB LOG; display the desired portion of the signal on the top 16 dB of the CRT display, then switch to 2 dB LOG. The top of the display, the LOG REF graticule, remains the same. The -70 dB graticule line becomes -14 dB (each major division becomes 2 dB).

NOTE

Do not make any VERTICAL GAIN or POSITION adjustments in 2 dB LOG as the front panel calibration will become invalid.

3-15. The LOG REF LEVEL control on the IF Section has three scales (see EQUIPMENT SUPPLIED in Section I): the red scale is used for LF Section log calibration, the black scale is used for RF Section log calibration, and the blue scale is used for linear calibration on all units. If the IF Section being used does not have the red scale, subtract 20 dB from the black scale to obtain the LOG REF level on the CRT.

3-16. First Mixer Balance

3-17. The first mixer in the 8556A is balanced to insure a low level of first local oscillator feedthrough appearing on the display. Excessive LO feedthrough may result in inaccurate amplitude calibration and excessive intermodulation distortion. With the dBm/dBV switch set to 50 Ω dBm and INPUT LEVEL set to -60 dBm/dBV, the first LO feedthrough (zero frequency marker) should be below -80 dBm. If it is above this level, perform the first mixer balance adjustment specified below.

amplifier is inserted, and the attenuator is set to 50 dB. If the amplifier response curve is at the -7 dB graticule line, the gain is 43 dB (50 dB - 7 dB).

3-47. Important Considerations. When using the tracking generator for swept response measurements, the spectrum analyzer BANDWIDTH and DISPLAY UNCAL light take on somewhat different significance. The BANDWIDTH setting mainly affects the average noise level and has only a secondary effect on resolution. Narrowing the BANDWIDTH improves dynamic range, but requires slower sweep rates. The DISPLAY UNCAL light in most cases will not apply. The best procedure in swept response measurements is to slow the scan rate until the display amplitude remains constant with changes in SCAN TIME PER DIVISION. At this point, the scan is the proper rate to satisfy the requirements of both the spectrum analyzer and the device under test.

3-48. Spurious responses are not displayed on the CRT due to the tracking signal source and receiver. Therefore, measurements may be made over a dynamic range limited only by gain compression as an upper limit and system noise as a lower limit.

3-49. Devices, such as filters, which may have attenuation greater than 100 dB can be measured. The response can be traced out on the CRT in two 70 dB segments, and the results can be photographed to give a composite picture.

3-50. Precise Frequency Measurements. It may be desired to measure the frequency of a low level signal which is close to a higher level signal. First, confirm that TRACK ADJ is correctly adjusted (see Figure 3-2), then connect a low frequency counter to the tracking generator's output. Using the MANUAL SCAN mode, scan the spectrum analyzer until you reach the peak of the signal response. The frequency displayed on the counter is the frequency of the signal. Resolution of 1 Hz is possible using narrow scan widths and bandwidths on the spectrum analyzer. (The counter gate time for this resolution is 1 second.)

3-51. This same method may be applied to the measurement of points on a frequency response curve. Use a high impedance counter and connect it to the tracking generator's output on a tee with the test device (see Figure 3-4). Then manually scan to a point of interest on the response curve and read the frequency. This method is useful when measuring the 3 dB or 6 dB bandwidth of a filter, discontinuities in a response characteristic, or identifying spurious modes on a device.

3-52. Variable Persistence and Storage Functions

3-53. With the 141T Display Section the operator can set trace persistence for a bright, steady trace that does not flicker, even on the slow sweeps required for narrow band analysis. The variable persistence also permits the display of low repetition rate pulses without flickering and, using the longest persistence, intermittent signals can be captured and displayed. The storage capability allows side-by-side comparison of changing signals.

3-54. Persistence and Intensity. The persistence and intensity determine how long a written signal will be visible. Specifically, PERSISTENCE controls the rate at which a signal is erased and INTENSITY controls the trace brightness as the signal is written. With a given PERSISTENCE setting, the actual time of trace visibility can be increased by greater INTENSITY. Since the PERSISTENCE control sets the rate of erasing a written signal, it follows that a brighter trace will require more time to be erased. Conversely, a display of low intensity will disappear more rapidly. The same principle applies to a stored display of high and low intensity.

CAUTION

Excessive INTENSITY will damage the CRT storage mesh. The INTENSITY setting for any sweep speed should just eliminate trace blooming with minimum PERSISTENCE setting.

3-55. Storage. The storage controls select the storage mode in which the CRT functions. In ERASE, STORE and WRITING SPEED are disconnected and all written signals are removed from the CRT. The STORE selector disconnects the WRITING SPEED AND ERASE functions and implements signal retention at reduced intensity. In the STORE mode, PERSISTENCE and INTENSITY have no function.

3-56. Writing Speed. In the FAST mode, the rate of erasing a written display is decreased. Since the erasing rate is decreased, the entire screen becomes illuminated more rapidly and the display is obscured. The effective persistence and storage time are considerably reduced.

3-57. Photographic Techniques

3-58. Excellent signal photography is possible when the Spectrum Analyzer is used with an oscilloscope camera and when proper techniques are employed. Both the HP 196B and the 197A Oscilloscope Cameras attach directly to the analyzer's CRT bezel without adapters. Both cameras also have an Ultra-Violet light source that causes a

uniform glow of the CRT phosphor. This gives the finished photograph a grey background that contrasts sharply with the white trace and the black graticule lines. Ultra-Violet illumination is normally used only when the CRT is of the non-

storage and fixed persistence type (140T Display Section). For a storage or variable persistence CRT (141T Display Section), a uniform gray background is obtained by simply taking the photograph in STORE rather than in VIEW.

3-18. Remove the top cover from the Display Section (with power off).

WARNING

Removing the top cover from the Display Section exposes the operator to dangerous potentials (up to 7000 volts).

3-19. Set the analyzer controls as follows:

FREQUENCY	0 kHz
BANDWIDTH	3 kHz
SCAN WIDTH	PER DIVISION
PER DIVISION	10 kHz
INPUT LEVEL	-60 dBm/dBV
dBm/dBV	50 Ω dBm
BASE LINE CLIPPER	ccw
VIDEO FILTER	10 kHz
SCAN TIME PER DIVISION	5 MILLISECONDS
LOG/LINEAR	10 dB LOG
LOG REF LEVEL	-40 dBm
SCAN MODE	INT
SCAN TRIGGER	AUTO
POWER	ON

NOTE

This procedure assumes that the analyzer is calibrated as specified in Figure 3-2 and has been allowed to warm up at least one-half hour.

3-20. Center the LO feedthrough signal on the display with the FREQUENCY control.

3-21. Using a non-metallic adjustment tool, alternately adjust C and R MIXER BALANCE ADJUSTMENTS (available on the LF Section top cover) to null the LO feedthrough.

3-22. When the signal is below -80 dBm, turn power off and replace the top cover.

3-23. OPERATING INSTRUCTIONS

3-24. The following instructions should enable an operator to make fast, accurate measurements with the low frequency analyzer. To define each instrument application is beyond the scope of this manual. For further details, there is a complete discussion of 8556A applications in Application Note 134. This application note is available from your local HP Sales and Service Office.

3-25. In general, operation of the Spectrum Analyzer may be accomplished through the following steps:

a. Set the analyzer to scan the appropriate frequency range with the proper resolution.

b. Adjust the amplitude scale as necessary for the measurement.

c. Complete the measurement, and interpret the results.

3-26. Setting the Frequency Scan

3-27. There are three ways to set the frequency scan on the 8556A. The first is the the 0-10f mode of operation. When this mode is selected, the spectrum analyzer scans from "zero" frequency to a preset upper limit selected by the PER DIVISION control. For example, if the PER DIVISION control is set to 10 kHz, and the 0-10f mode is selected, the spectrum analyzer will scan from 0 to 100 kHz, 10 kHz per division. Scans may be selected from 20 Hz per division to 20 kHz per division in a 1, 2, 5 sequence.

3-28. The second way to set the frequency scan is the PER DIVISION mode. In this mode, the frequency scan is symmetrical about the CENTER FREQUENCY tuned by the FREQUENCY control. The CENTER FREQUENCY dial indicates this frequency in two ranges, 0-30 kHz or 0-300 kHz. The horizontal scale is then selected by the PER DIVISION setting.

3-29. The third way is the ZERO scan mode. The spectrum analyzer becomes a fixed-tuned receiver at the frequency indicated by the CENTER FREQUENCY dial. In this mode, amplitude variations are displayed versus time on the CRT.

3-30. Once the proper frequency scan is chosen, the resolution needed for the particular measurement should be determined. Resolution is mainly a function of the IF bandwidth selected. As narrower IF bandwidths are used, the resolution increases. At the same time, the spectrum analyzer must be swept at a slower rate. The bandwidth used should be only as narrow as is necessary for the particular application. The best procedure is to select the bandwidth necessary for the desired resolution, and then slow the scan rate (SCAN TIME PER DIVISION) until the DISPLAY UNCAL light is unlit.

3-31. Adjusting the Amplitude Scale

3-32. Once the desired signals are displayed on the CRT the amplitude is set to give an optimum display. The first consideration is how the amplitude is to be measured. The 8556A can measure power in dBm (for 50 ohm or 600 ohm systems), and it can measure voltage on a linear scale or in dB referred to one volt (dBV) on a log scale.

3-33. If power is the desired parameter, set the dBm/dBV switch to dBm for the appropriate

FRONT PANEL FEATURES

- 1 **DISPLAY UNCAL:** warning light indicates that the CRT display has become uncalibrated due to incompatible settings of SCAN WIDTH, SCAN TIME PER DIVISION, BANDWIDTH, and VIDEO FILTER controls.
- 2 **FREQUENCY:** tunes the CENTER FREQUENCY in SCAN WIDTH PER DIVISION and ZERO scan modes. FINE TUNE allows high resolution adjustments in narrow scans.
- 3 **ZERO ADJ:** calibrates CENTER FREQUENCY dial for "zero" frequency.
- 4 **300 kHz ADJ:** calibrates CENTER FREQUENCY dial for 300 kHz.
- 5 **BANDWIDTH:** selects resolution bandwidth of the spectrum analyzer from 10 Hz to 10 kHz in a 1, 3 sequence. (8552A, 50 Hz and 100 Hz to 300 kHz in a 1, 3 sequence.)
- 6 **AMPL CAL:** calibrates display amplitude for absolute voltage and power measurements.
- 7 **CENTER FREQUENCY:** dial indicates the CENTER FREQUENCY for SCAN WIDTH PER DIVISION and ZERO scan modes. Calibrated in 5 kHz increments for 0-300 kHz range and 500 Hz increments for 0-30 kHz range.
- 8 **SCAN WIDTH:** selects spectrum analyzer frequency scanning mode. 0-10f repetitively tunes the spectrum analyzer from "zero" frequency to ten times the setting of the PER DIVISION control. (e.g., with PER DIVISION control set at 1 kHz, scan would be from 0-10 kHz, or 1 kHz per division.) PER DIVISION mode scans the spectrum analyzer symmetrically about the CENTER FREQUENCY with a scan width set by the PER DIVISION control. In the ZERO scan mode, the analyzer becomes a fixed frequency receiver at the CENTER FREQUENCY.
- 9 **PER DIVISION:** selects the CRT horizontal calibration (frequency scale) in the PER DIVISION and 0-10f frequency scan modes.
- 10 **TRACKING ADJ:** tunes the TRACKING GEN OUT frequency to precisely track the tuning frequency of the spectrum analyzer.
- 11 **INPUT LEVEL:** adjusts the input signal level to the input mixer and input preamplifier to maximize dynamic range. This control should be set to agree with the signal level read on the CRT.
- 12 **TRACKING GEN LEVEL:** adjusts the output level of the tracking signal present at the TRACKING GEN OUT. When the CAL position is selected, it gives an output of 100 mV for calibrating the spectrum analyzer display. The output can be increased to 3V.
- 13 **RANGE kHz:** selects CENTER FREQUENCY dial range of 0-30 kHz or 0-300 kHz.
- 14 **INPUT:** one megohm unbalanced input for signals to be measured.
- 15 **dBm/dBV:** selects log display absolute calibration for dBV or dBm referred to 50 ohms or 600 ohms. For correct dBm measurements, an external termination of the proper impedance must be provided for the input signals.
- 16 **TRACKING GEN OUT:** output signal tracks the spectrum analyzer tuning frequency. The signal may be used for swept frequency response measurements or to drive a frequency counter for accurate frequency measurements. The signal output also serves to accurately calibrate the display for absolute amplitude.
- 17 **20 kHz MARKERS:** places crystal controlled markers with 20 kHz spacing on CRT. These markers are accurate to 0.01%, and are useful for calibrating the frequency axis.
- 18 **CAL OUTPUT:** -30 dBm, 30 MHz signal used for calibrating amplitude on other tuning sections (8553B, 8554L, 8555A).
- 19 **PEN LIFT OUTPUT, TRIG/BLANK INPUT:** provides +14 V pen lift signal for use with X-Y recorders during retrace in SINGLE and INT SCAN MODES with VIDEO, LINE, or AUTO SCAN TRIGGER. It serves as an input connector for external blanking signal in the EXT SCAN MODE. When EXT SCAN TRIGGER is selected, it becomes an input connector for the external trigger signal.
- 20 **VERTICAL OUTPUT:** provides output proportional to vertical deflection on CRT. Approximately 100 mV per major division with 100 ohm output impedance.

Figure 3-1. Front Panel Features (1 of 4)

(See foldout, page 3-5, for illustration)

FRONT PANEL FEATURES

- 21 SCAN IN/OUT:** provides output voltage proportional to CRT horizontal deflection. 0 volts equals center screen with 1 volt per division (−5 to +5V full screen). Output voltage available in SINGLE, MAN, and INT SCAN MODES. In EXT SCAN MODE, the connector is used as an input for 0 to +8V external scan signal.
- 22 DISPLAY ADJUST:** these controls adjust the deflection circuit gain and offset levels to match the IF section to a particular display section.
- 23 LOG REF LEVEL · LINEAR SENSITIVITY:** these controls set the absolute amplitude calibration of the CRT display. In the 10 dB LOG or 2 dB LOG modes, the sum of the two control settings determines the LOG REF LEVEL (top graticule line on CRT). In the LINEAR mode, the product of the two control settings determines the CRT scale factor in volts per division. A special knob is provided for use with the 8556A. This knob is described under OPERATING CONSIDERATIONS (paragraph 3-15).
- 24 LOG/LINEAR:** selects display mode for logarithmic display with scale factors of 10 dB per division or 2 dB per division or LINEAR display with scale factor selected by LINEAR SENSITIVITY (2 dB per division not available with 8552A).
- 25 SCAN TRIGGER:** selects synchronizing trigger when in the INT SCAN MODE.
- AUTO:** scan free runs.
- LINE:** scan synchronized to power line frequency.
- EXT.:** scan initiated by external positive or negative pulses (2–20V) applied to TRIG/BLANK INPUT.
- VIDEO:** scan internal synchronized to envelope of RF input signal. Signal amplitude of 1.5 divisions peak-to-peak (min.) required on display section CRT.
- 26 SCAN MODE:** selects scan source.
- INT.:** analyzer repetitively scanned by internally generated ramp; synchronization selected by SCAN TRIGGER. SCANNING lamp indicates time during which analyzer is being scanned.
- EXT.:** scan determined by externally applied 0 to +8V signal at SCAN IN/OUT.
- MAN:** scan determined by MANUAL SCAN control; scan continuously variable across CRT in either direction. (Not available with 8552A.)
- SINGLE:** single scan initiated by front panel push-button. SCANNING lamp indicates time during which analyzer is being scanned.
- 27** Initiates or resets scan when SINGLE SCAN MODE is selected.
- 28 SCAN TIME PER DIVISION:** selects time required to scan one major division on CRT display. Control acts as time base for time domain operation in ZERO scan.
- 29 VIDEO FILTER:** post detection low pass filter for effective averaging of distributed signals such as noise. Bandwidths of 10 kHz, 100 Hz, and 10 Hz selectable; nominal bandwidth 400 kHz in OFF position. (10 Hz position not available with 8552A.)
- 30 BASE LINE CLIPPER:** allows blanking of the bright base line area of the CRT for better photography and improved display of transient phenomena.
- 31 MANUAL SCAN:** controls spectrum analyzer horizontal scan in the MAN SCAN MODE. (Not available on 8552A.)
- 32 CAL 10V and 1V:** 10V or 1V square wave used to calibrate time domain plug-ins ONLY.
- 33 FOCUS:** focuses CRT spot for best definition.
- 34 BEAM FINDER:** returns CRT trace to the center of the screen regardless of deflection potentials with time domain plug-ins ONLY.
- 35 NON STORAGE, CONV:** defeats the storage and variable persistence features of the CRT. Persistence is that of the standard P31 phosphor.
- 36 INTENSITY:** adjusts the intensity of the trace on the CRT.
- 37 ERASE:** erases the CRT in the WRITING SPEED FAST or STD mode of operation. CRT ready to record immediately after erasure.

CAUTION

Excessive INTENSITY will damage the CRT storage mesh. Whenever trace blooming occurs, turn INTENSITY down.

Figure 3-1. Front Panel Features (2 of 4)

FRONT PANEL FEATURES

- 38 PERSISTENCE:** adjusts the trace fade rate from 0.1 sec. to more than 2 minutes in the WRITING SPEED FAST or STD modes of operation.
- 39 WRITING SPEED FAST, STD:** these controls select the writing speed of the CRT in the PERSISTENCE mode of operation. The WRITING SPEED STD mode is almost always selected for spectrum analysis applications.
- 40 STORE TIME:** controls the storage time and relative brightness of the display in the STORE mode of operation. Storage time more than 2 minutes at maximum brightness, more than 2 hours at minimum brightness.
- 41 STORE:** stores the display on the CRT for extended viewing or photography. The CRT does not write in the STORE mode.
- 42 POWER:** controls power to the mainframe and to both plug-ins.
- 43 ASTIG:** adjusts the shape of the CRT spot.
- 44 TRACE ALIGN:** used to adjust the CRT trace to align with the horizontal graticule lines.
- 45 CRT Graticule with LOG and LIN scales.** LOG REF is the level used to reference the amplitude of displayed signals in the LOG display mode. LINEAR display amplitude is referenced from the baseline.

Figure 3-1. Front Panel Features (3 of 4)

FRONT PANEL FEATURES

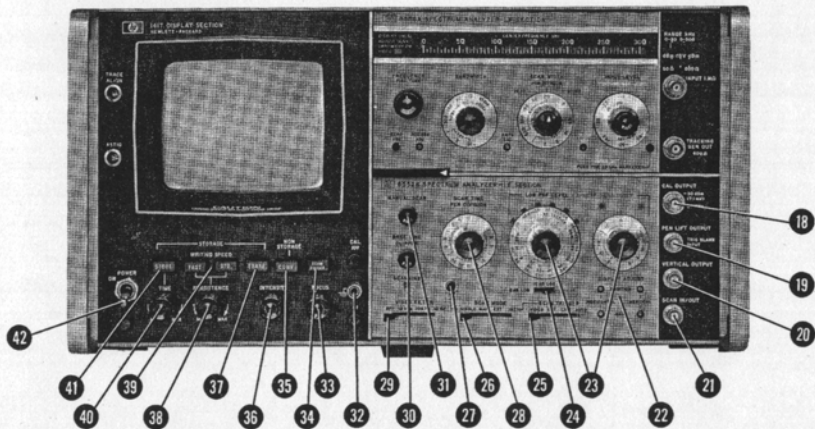
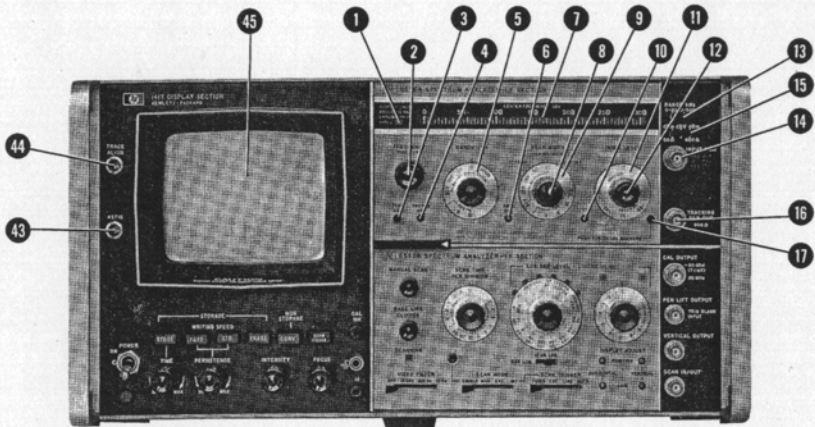


Figure 3-1. Front Panel Features (4 of 4)

OPERATIONAL ADJUSTMENTS

1 INPUT POWER

a. Set 115/230 switch to correspond with available input voltage. (The instrument is fused for 115 volt, 50/60 Hz operation; if 230 volt power is used, refer to the Display Section service manual for fuse replacement procedures.)

b. Connect line power cord to instrument jack and to a line power outlet.

2 INTENSITY MODULATION

Set INT/EXT switch to INT. (Set to EXT only if CRT Z axis is to be externally modulated — normally only used with 1400 series oscilloscope plug-ins.)

3 FOCUS AND ASTIGMATISM

a. Make the following instrument control settings:

RANGE	0-300 kHz
FREQUENCY	150 kHz
FINE TUNE	Centered
BANDWIDTH	10 kHz
SCAN WIDTH	PER DIVISION
PER DIVISION	20 kHz
INPUT LEVEL	-20 dBm/dBV
dBm/dBV	dBV
20 kHz MARKERS	Out
SCAN TIME PER DIVISION	5 MILLISECONDS
LOG REF LEVEL	-10 dBV
Vernier	ccw
LOG/LINEAR	10 dB LOG
VIDEO FILTER	OFF
SCAN MODE	INT
SCAN TRIGGER	AUTO
BASE LINE CLIPPER	ccw
WRITING SPEED	STD
PERSISTENCE	MIN
INTENSITY	12 o'clock
POWER	ON

b. Adjust INTENSITY as needed. (Whenever blooming occurs on CRT, turn INTENSITY down.) Set LOG REF LEVEL maximum counterclockwise. Using the VERTICAL POSITION control, bring the trace to the -40 dB graticule line.

c. Switch the SCAN MODE to MAN, and use the MANUAL SCAN to bring the CRT dot to the center of the screen. Adjust FOCUS and ASTIG for the smallest round dot possible.

4 TRACE ALIGNMENT

Set SCAN MODE to INT. Adjust TRACE ALIGN to set the trace parallel to the horizontal graticule lines.

5 HORIZONTAL POSITION AND GAIN

a. Alternately adjust HORIZONTAL GAIN and HORIZONTAL POSITION so that the trace just fills the horizontal graticule line.

b. Using the VERTICAL POSITION control, bring the trace to the bottom graticule line (ignore any slight misalignment of the trace).

6 VERTICAL POSITION AND GAIN

a. Connect TRACKING GEN OUT to the INPUT (do NOT use a feedthrough termination). Set the TRACKING GEN LEVEL to CAL. Set the VIDEO FILTER to 10 kHz. Use the LOG REF LEVEL vernier to set the trace to the -70 dB graticule line at the center of the CRT. (Adjust AMPL CAL counterclockwise, if necessary, to lower trace.)

b. Turn the LOG REF LEVEL clockwise 7 steps (without moving vernier) while observing the trace. The trace should move up the CRT in 10 dB steps. If it does not, adjust VERTICAL GAIN to bring the trace to the top graticule line.

c. Turn the LOG REF LEVEL fully counterclockwise and repeat steps 6 a. and 6 b. until no further adjustment is necessary.

7 AMPLITUDE CALIBRATION

a. Set the LOG REF LEVEL to -20 dBV (set vernier to zero). Adjust AMPL CAL to bring the trace to the top graticule line at the center of the screen.

b. Set the LOG/LINEAR switch to LINEAR, and set LINEAR SENSITIVITY to 20 mV per division. Make any fine adjustment of the AMPL CAL which is necessary to bring the trace to the fifth graticule line (5 x 20 mV = 100 mV).

8 TRACKING ADJUSTMENT

a. Return the LOG/LINEAR switch to 10 dB LOG. Set the LOG REF LEVEL to -10 dBV, and set the SCAN WIDTH to ZERO. Reduce the BANDWIDTH to 10 Hz (50 Hz on 8552A). Adjust TRACK ADJ to bring the trace as high as possible on the screen.

b. Set the LOG/LINEAR switch to 2 dB LOG (or LINEAR) and repeat the peaking procedure, then return to 10 dB LOG.

OPERATIONAL ADJUSTMENTS

9 FREQUENCY CALIBRATION

a. Disconnect TRACKING GEN OUT from INPUT and set the controls as follows:

FREQUENCY	0 kHz
RANGE	0-30 kHz
FINE TUNE	Centered
BANDWIDTH	300 Hz
SCAN WIDTH	PER DIVISION
PER DIVISION	1 kHz
20 kHz MARKERS	In
SCAN TIME PER DIVISION	50 MILLISECONDS
VIDEO FILTER	OFF

b. Center LO feedthrough signal, at CENTER FREQUENCY graticule on the display, with ZERO ADJ. The dial should be accurately set to 0 kHz.

NOTE

If using an 8552A IF Section and ZERO ADJ will not zero the LO feedthrough, see paragraph 5-30 in Section VI.

c. Set RANGE to 0-300 kHz, and slowly tune FREQUENCY to 300 kHz, counting 20 kHz markers as they pass the CENTER FREQUENCY graticule on the display. Center the fifteenth marker (300 kHz) on the CENTER FREQUENCY graticule.

d. Adjust 300 kHz ADJ so that the dial reads 300 kHz when the fifteenth marker is centered.

e. Repeat steps 9b through 9d until no further adjustment is necessary.

NOTE

Some minor readjustment of tracking adjustment and frequency calibration controls may be necessary from time to time for narrowband operation.

Figure 3-2. Operational Adjustments (1 of 3)

Figure 3-2. Operational Adjustments (2 of 3)

OPERATIONAL ADJUSTMENTS

9 FREQUENCY CALIBRATION

a. Disconnect TRACKING GEN OUT from INPUT and set the controls as follows:

FREQUENCY 0 kHz
 RANGE 0-30 kHz
 FINE TUNE Centered
 BANDWIDTH 300 Hz
 SCAN WIDTH PER DIVISION
 PER DIVISION 1 kHz
 20 kHz MARKERS In
 SCAN TIME PER DIVISION .. 50 MILLISECONDS
 VIDEO FILTER OFF

b. Center LO feedthrough signal, at CENTER FREQUENCY graticule on the display, with ZERO ADJ. The dial should be accurately set to 0 kHz.

NOTE

If using an 8552A IF Section and ZERO ADJ will not zero the LO feedthrough, see paragraph 5-30 in Section VI.

c. Set RANGE to 0-300 kHz, and slowly tune FREQUENCY to 300 kHz, counting 20 kHz markers as they pass the CENTER FREQUENCY graticule on the display. Center the fifteenth marker (300 kHz) on the CENTER FREQUENCY graticule.

d. Adjust 300 kHz ADJ so that the dial reads 300 kHz when the fifteenth marker is centered.

e. Repeat steps 9b through 9d until no further adjustment is necessary.

NOTE

Some minor readjustment of tracking adjustment and frequency calibration controls may be necessary from time to time for narrowband operation.

OPERATIONAL ADJUSTMENTS

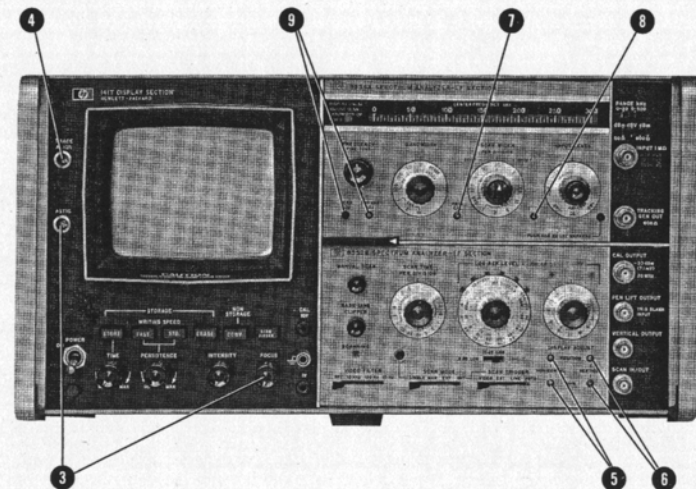
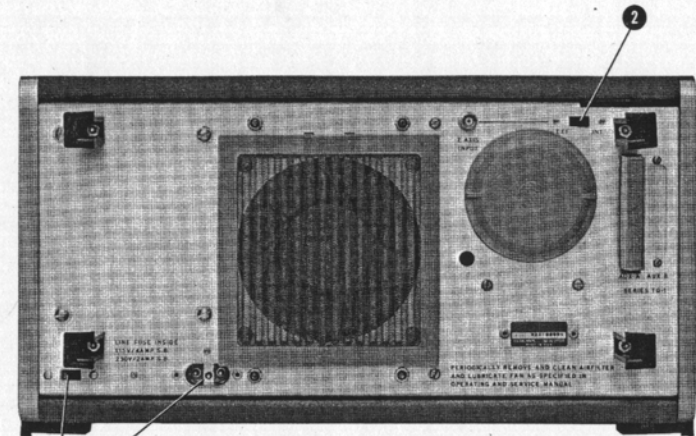


Figure 3-2. Operational Adjustments (2 of 3)

Figure 3-2. Operational Adjustments (3 of 3)

impedance (600 ohms or 50 ohms). The input should then be terminated with a feedthrough termination for the impedance selected.

3-34. For voltage measurements, the dBm/dBV switch can be set to dBV for a log display, or the LOG/LINEAR switch can be set to LINEAR for a linear display. If no feedthrough termination is used, the spectrum analyzer will display the open circuit voltage. If a feedthrough termination is used, the voltage displayed will be that developed across the impedance of the termination.

3-35. The next step is to insure that the spectrum analyzer is operating linearly. That is, that all spectral components displayed are present at the input and not generated in the spectrum analyzer. This is readily accomplished: read the amplitude of the largest signal on the CRT, and set the INPUT LEVEL control to the setting nearest this amplitude. For example, if the largest signal on the display reads -13 dBV, the INPUT LEVEL control would be set to -10 dBm/dBV.

3-36. Now set the LOG REF LEVEL or LINEAR SENSITIVITY controls to give the desired display. One convenient way to set the LOG REF LEVEL is to set the -10 dBm/dBV position under the right hand indicator light. The -60 dBm/dBV position will then fall under the left hand indicator light. In this position, setting the INPUT LEVEL control to the amplitude of the largest signal will bring that signal to the top of the CRT. This gives the widest possible display dynamic range for signals between -60 dBm/dBV and -10 dBm/dBV.

3-37. Using the Tracking Generator

3-38. The tracking generator is a flat signal source whose output frequency precisely tracks the spectrum analyzer's tuning frequency. This output can be used as a source to test devices for frequency response. Also, by measuring the frequency of the tracking generator's output with a frequency counter, the frequency of signals appearing on the spectrum analyzer display can be precisely determined.

3-39. Frequency Response Measurements. The frequency scan of the spectrum analyzer is set in much the same way as described under paragraph 3-26. The tracking generator's output frequency is determined by the spectrum analyzer's scan. If a device is being tested from 0-20 kHz, it is only necessary to set the spectrum analyzer to scan 0-20 kHz using the 0-10f mode.

3-40. The device under test will be connected in the signal path between the TRACKING GEN OUT and the INPUT. Some consideration must be

given to the input and output impedances of the test device. If the device has a 600 ohm input impedance, the tracking generator can be connected directly to the device. The 50-ohm Tracking Generator Shunt supplied with the 8556A should be used between the tracking generator and the test device for devices with a 50-ohm input impedance.

3-41. The output of the device should be terminated in its characteristic impedance. 50 ohm or 600 ohm devices can be terminated using the feedthrough terminations, and high impedance devices can be connected directly to the spectrum analyzer INPUT (see Figure 3-3). Measure devices which have a different impedance by using a simple resistive termination.

3-42. The tracking generator output level is 100 mV (-20 dBV) open circuit in the CAL position. This amounts to 50 mV (-26 dBV) across 600 ohms. If the 50 ohm shunt is used, the output will be 4.17 mV or -34.6 dBm into 50 ohms. The output level increases as TRACKING GEN LEVEL is turned clockwise from the CAL position.

3-43. System Calibration. The TRACKING GEN OUT should be connected through any necessary terminations to the spectrum analyzer INPUT. The TRACKING GEN LEVEL can then be adjusted to bring the trace to the top graticule line, thus providing a convenient reference. The INPUT LEVEL control should be set to -20 dBm/dBV and the LOG REF LEVEL set to 0 dBm/dBV for maximum measurement range on passive devices. (Use the dBm scale for 50 ohm devices and the dBV scale for 600 ohm devices.)

3-44. Insert the test device in the circuit, and its frequency response will be displayed directly on the CRT. Insertion loss can be read directly from the dB scale on the CRT.

3-45. Testing Amplifiers. When measuring amplifier frequency response, some provision must be made for the gain of the amplifier to prevent damage to the spectrum analyzer. A step attenuator should be added to the test setup to decrease the tracking generator level by a known amount (see Figure 3-4).

3-46. Set the attenuator to 0 dB and perform the calibration procedure described under System Calibration. Then the attenuation should be increased by an amount greater than the gain of the amplifier under test. The gain of the amplifier will be the sum of the attenuator setting and the dB reading from the CRT graticule at any point. (Remember, this is a negative number on the graticule.) For example, the spectrum analyzer is calibrated for a reference at the top of the CRT. Now a test

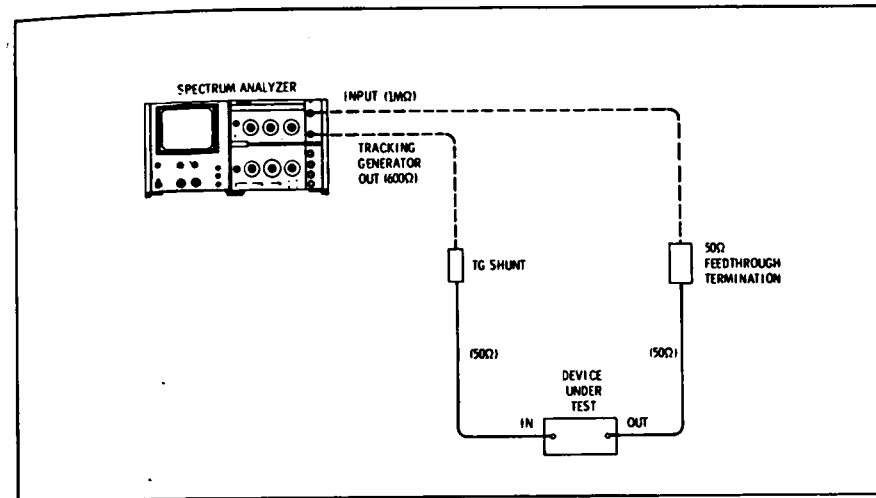


Figure 3-3. Typical Frequency Response Measurement (in 50 Ohms)

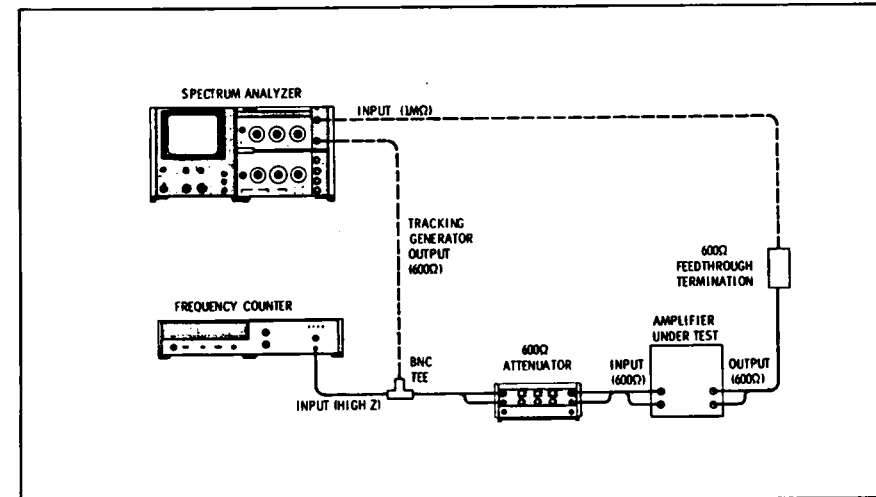


Figure 3-4. Typical Amplifier Frequency Response Measurement (in 600 Ohms) Using a Frequency Counter

SECTION IV

PERFORMANCE TESTS

4-1. INTRODUCTION

4-2. This section provides instructions for performance testing the Model 8556A Spectrum Analyzer LF Section. Front panel checks for routine inspection are given in Table 4-1. The performance tests verify that the instrument meets the specifications listed in Table 1-1.

4-3. Perform the tests in procedural order with the test equipment called for, or with its equivalent. During the tests, all circuit boards, shields, covers and attaching hardware must be in place, and the LF and IF Sections must be installed in the Display Section. Allow the analyzer to warm up at least one hour before performing the tests.

4-4. EQUIPMENT REQUIRED

4-5. Test equipment and test equipment accessories for the performance tests (designated "P" in the "use" column) are specified in Tables 1-4 and 1-5. Equipment other than that listed may be used providing that it meets or exceeds the minimum specifications listed in the tables.

4-6. OPERATIONAL ADJUSTMENTS

4-7. Before proceeding to the performance tests, perform the operational adjustments specified in Figure 3-2 (in Section III). These adjustments correct for minor differences between units and ensure that the LF Section, IF Section and Display Section are properly calibrated.

4-8. FRONT PANEL CHECKS

4-9. The front panel checks provide a quick method for verifying that the LF Section is operating correctly. After performing the operational adjustments described in Figure 3-2, set the analyzer's controls as specified in Table 4-1 and perform the checks.

4-10. TEST SEQUENCE

4-11. The performance tests are suitable for incoming inspection, troubleshooting, and preventive maintenance. A test card for recording data is included at the back of this section.

4-12. Perform the tests in the following order:

- a. Allow analyzer to warm up one hour.
- b. Perform operational adjustments listed in Figure 3-2.
- c. Perform front panel checks listed in Table 4-1.
- d. Perform the performance tests in the order given.

4-13. Each test is arranged so that the specification is written as it appears in Table 1-1. Next is a description of the test that includes any special instructions. Each test that requires test equipment has a test setup drawing and a list of required equipment.

Table 4-1. Front Panel Checks

Function	Procedure	Result
Calibration	1) Perform operational adjustments specified in Section III (Figure 3-2), then set analyzer as follows: RANGE 0-300 kHz FREQUENCY 0 kHz BANDWIDTH 10 kHz SCAN WIDTH PER DIVISION PER DIVISION 20 kHz INPUT LEVEL -30 dBm/dBV dBm/dBV 600Ω dBm 20 kHz MARKERS Out SCAN TIME PER DIVISION 50 MILLISECONDS LOG/LINEAR 10 dB LOG LOG REF LEVEL -20 dBm/dBV VIDEO FILTER OFF SCAN MODE INT SCAN TRIGGER AUTO	1) Analyzer calibrates normally.
BASE LINE CLIPPER	2) Turn BASE LINE CLIPPER full clockwise.	2) At least bottom two divisions blank on CRT.
Scan	3) Turn BASE LINE CLIPPER full counterclockwise. 4) Turn SCAN TIME PER DIVISION through its range. 5) Return SCAN TIME PER DIVISION to 50 MILLISECONDS. Center LO feedthrough on CRT with FREQUENCY.	4) Scan occurs in all positions.
BANDWIDTH & SCAN WIDTH PER DIVISION	6) Reduce SCAN WIDTH PER DIVISION to 20 Hz, reducing BANDWIDTH to maintain LO feedthrough about 2 divisions wide. Reduce SCAN TIME PER DIVISION to keep DISPLAY UNCAL lamp unlit; keep signal centered with FREQUENCY and FINE TUNE.	6) LO feedthrough narrows as BANDWIDTH is reduced and widens as SCAN WIDTH PER DIVISION is reduced.
SCAN WIDTH 0-10f	7) Set SCAN WIDTH to 0-10f, PER DIVISION to 20 kHz, BANDWIDTH to 1 kHz, and SCAN TIME PER DIVISION to 50 MILLISECONDS. 8) Depress 20 kHz MARKERS switch.	7) LO feedthrough appears at left graticule on CRT. 8) Markers appear at about every major
DISPLAY UNCAL light	9) Increase SCAN TIME PER DIVISION to 20 MILLISECONDS.	9) DISPLAY UNCAL light illuminates.

PERFORMANCE TESTS

4-14. TRACKING GENERATOR AMPLITUDE

SPECIFICATIONS:

Amplitude Range: Continuously variable from 100 mV rms to greater than 3 V rms into an open circuit.
 Amplitude Accuracy: With TRACKING GEN LEVEL in CAL position, output level at 100 kHz is 100 mV ±0.3 dB into an open circuit.
 Frequency Response: ±0.25 dB, 50 Hz to 300 kHz.

DESCRIPTION: An AC Voltmeter is used to measure the amplitude range and accuracy and the frequency response of the tracking generator.

EQUIPMENT:

- AC Voltmeter HP 400EL
- Frequency Counter HP 5327C
- 24" BNC Cable Assy HP 11086A

PROCEDURE:

1. Connect equipment as shown in Figure 4-1, connecting AC Voltmeter directly to TRACKING GEN OUT with 24" BNC cable.
2. Set analyzer as follows:
 RANGE 0-300 kHz
 FREQUENCY 100 kHz
 SCAN WIDTH ZERO
 TRACKING GEN LEVEL CAL 100 mV

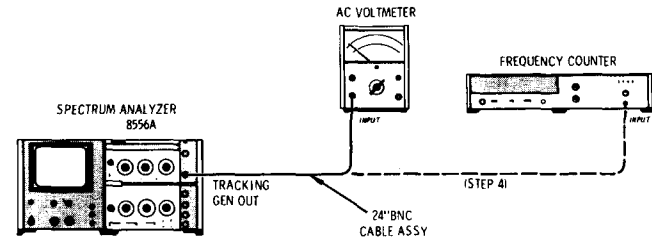


Figure 4-1. Tracking Generator Test Setup

3. Set voltmeter to measure 100 mV. It should read 100 mV ±3.5 mV.
 Amplitude Accuracy: 96.5 _____ 103.5 mV
4. Disconnect BNC cable from voltmeter and connect it to Frequency Counter. Set TRACKING GEN LEVEL fully clockwise, and tune FREQUENCY and FINE TUNE for a 50 Hz reading on counter.

PERFORMANCE TESTS

4-14. TRACKING GENERATOR AMPLITUDE (cont'd)

- Set voltmeter to measure 3 volts. Disconnect BNC cable from counter and re-connect it to voltmeter. Voltmeter should read $\geq 3V$:

Amplitude Range: 3V _____

- Reset TRACKING GEN LEVEL to CAL 100 mV, and reset voltmeter to measure 100 mV.
- Slowly tune FREQUENCY from 50 Hz (set in step 5) to 300 kHz. Voltmeter should indicate a maximum variation of 0.5 dB (± 0.25 dB) through entire range:

Frequency Response: _____ 0.5 dB

4-15. MARKER ACCURACY

SPECIFICATION: RF markers every 20 kHz accurate to within $\pm 0.01\%$.

DESCRIPTION: The tracking generator is peaked to ensure that it is accurately tracking the analyzer tuning, and a frequency counter is connected to TRACKING GEN OUTPUT. Marker accuracy is tested using MANUAL SCAN (with 8552B IF Section) or ZERO SCAN (with 8552A IF Section) to tune the analyzer to the markers.

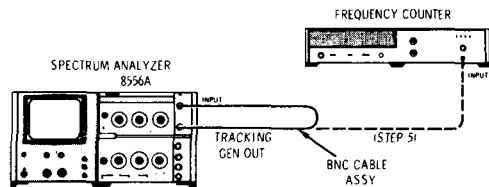


Figure 4-2. Marker Accuracy Test Setup

EQUIPMENT:

- Frequency Counter HP 5327C
- BNC Cable Assembly HP 10503A
- Tuning Tool (or small screwdriver) HP 8710-1010

PROCEDURE:

- Connect equipment as shown in Figure 4-2, connecting TRACKING GEN OUT to analyzer INPUT with BNC cable.

PERFORMANCE TESTS

4-15. MARKER ACCURACY (cont'd)

- Set analyzer as follows:

RANGE	0—300 kHz
FREQUENCY	300 kHz
FINE TUNE	Centered
BANDWIDTH	10 Hz (8552B) 50 Hz (8552A)
SCAN WIDTH	ZERO
PER DIVISION	1 kHz
TRACKING GEN LEVEL	Cal 100 mV
INPUT LEVEL	-20 dBm/dBV
dBm/dBV	dBV
20 kHz MARKERS	Out
SCAN TIME PER DIVISION	5 MILLISECONDS
LOG REF LEVEL	-10 dBV
LOG/LINEAR	10 dB LOG
VIDEO FILTER	OFF
SCAN MODE	INT
SCAN TRIGGER	AUTO
BASE LINE CLIPPER	ccw

- Using tuning tool or small screwdriver, adjust TRACK ADJ to peak trace as high as possible on CRT display.
- Set LOG/LINEAR to LINEAR and LINEAR SENSITIVITY to 20 mV/DIV and, again, peak trace.
- Disconnect TRACKING GEN OUT from analyzer INPUT; connect TRACKING GEN OUT to Frequency Counter (if necessary, increase TRACKING GEN LEVEL to get reading on counter).
- Depress 20 kHz MARKERS switch, set BANDWIDTH to 300 Hz, and set SCAN WIDTH to PER DIVISION. Set LINEAR SENSITIVITY to 2 mV/DIV, SCAN TIME PER DIVISION to 50 MILLISECONDS, and center 300 kHz marker on CRT display with FREQUENCY and FINE TUNE.
- Set SCAN WIDTH PER DIVISION to 20 Hz, BANDWIDTH to 10 Hz, and SCAN MODE to MAN. Use MANUAL SCAN knob to set dot on CRT to peak of marker. Frequency Counter should read 300 kHz ± 30 Hz:

Marker Accuracy: 299,970 _____ 300,030 Hz

NOTE

With 8552A IF Section, perform test with SCAN WIDTH set to ZERO and BANDWIDTH set to 50 Hz; peak trace with FINE TUNE to get reading.

- Set SCAN MODE to INT, and tune FREQUENCY down to next marker (should be at 280 kHz).
- Set SCAN MODE to MAN and use MANUAL SCAN knob to set dot on CRT to peak of marker. Counter should read 280 kHz ± 28 Hz:

Marker Accuracy: 279,972 _____ 280,028 Hz

PERFORMANCE TESTS

4-16. SCAN WIDTH ACCURACY

SPECIFICATION:

With 8552B IF Section:

Frequency error between any two points on the display is less than $\pm 3\%$ of the indicated frequency separation.

With 8552A IF Section:

Frequency error between any two points on the display is less than $\pm 5\%$ of the indicated frequency separation.

DESCRIPTION: Internal 20 kHz markers are used to test scan width accuracy on the CRT display.

PROCEDURE:

- Set analyzer as follows:

RANGE	0–300 kHz
FREQUENCY	100 kHz
FINE TUNE	Centered
BANDWIDTH	1 kHz
SCAN WIDTH	PER DIVISION
PER DIVISION	20 kHz
INPUT LEVEL	–20 dBm/dBV
dBm/dBV	dBV
20 kHz MARKERS	In
SCAN TIME PER DIVISION	50 MILLISECONDS
LOG REF LEVEL	–10 dBV
LOG/LINEAR	10 dB LOG
VIDEO FILTER	OFF
SCAN MODE	INT
SCAN TRIGGER	AUTO
BASE LINE CLIPPER	ccw

- Note that a 20 kHz marker appears at about every major division on the CRT display. Tune FREQUENCY and FINE TUNE to center a marker on the –4 graticule line (see Figure 4-3).
- Measure amount of error, in divisions, that the marker deviates from the +4 graticule line. Marker should appear on the +4 graticule line plus or minus the specified tolerance (for IF Section being used):

With 8552B IF Section, ± 0.24 major divisions: +3.76 ____ +4.24

With 8552A IF Section, ± 0.4 major divisions: +3.60 ____ +4.40

- Set BANDWIDTH to 300 Hz, SCAN TIME PER DIVISION to 0.1 SECONDS, and SCAN WIDTH PER DIVISION to 5 kHz. Turn FREQUENCY and FINE TUNE to center a marker on the –4 graticule line.
- Measure amount of error, in divisions, that the marker deviates from the +4 graticule line. Marker should appear on the +4 line plus or minus the specified tolerance:

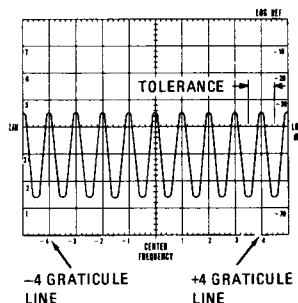


Figure 4-3. Scan Width Accuracy Display

PERFORMANCE TESTS

4-16. SCAN WIDTH ACCURACY (cont'd)

With 8552B IF Section, ± 0.24 major divisions: +3.76 ____ +4.24With 8552A IF Section, ± 0.4 major divisions: +3.60 ____ +4.40

NOTE

If 8556A appears to be out of tolerance, re-check scan width accuracy at 160, 220, and 280 kHz. If 8556A scan width accuracy is within tolerance at any frequency, check IF Section scan time accuracy.

4-17. CENTER FREQUENCY ACCURACY

SPECIFICATION: After 1 hour warmup, zero and 300 kHz adjustments, and with the FINE TUNE centered, the dial indicates the display center frequency within the following specifications:

With 8552B IF Section:

0–30 kHz Range: ± 500 Hz0–300 kHz Range: ± 3 kHz

With 8552A IF Section:

0–30 kHz Range: ± 1 kHz0–300 kHz Range: ± 5 kHz

DESCRIPTION: Dial accuracy is tested using internal 20 kHz markers. Any error between the CENTER FREQUENCY dial reading and the marker frequency is measured on the CRT display.

PROCEDURE:

- Set analyzer as follows:

RANGE	0–300 kHz
FREQUENCY	20 kHz
FINE TUNE	Centered
BANDWIDTH	300 Hz
SCAN WIDTH	PER DIVISION
PER DIVISION	1 kHz
INPUT LEVEL	–20 dBm/dBV
dBm/dBV	dBV
20 kHz MARKERS	In
SCAN TIME PER DIVISION	50 MILLISECONDS
LOG REF LEVEL	–10 dBV
LOG/LINEAR	10 dB LOG
VIDEO FILTER	OFF
SCAN MODE	INT
SCAN TRIGGER	AUTO
BASE LINE CLIPPER	ccw

- Using FREQUENCY control, center the dial marker on the CENTER FREQUENCY dial every 20 kHz from 20 kHz to 300 kHz (for example, 40 kHz, 60 kHz, 80 kHz, etc.). At each 20 kHz point, a 20 kHz marker should appear at CENTER FREQUENCY graticule on the CRT within the tolerance shown below:

With 8552B IF Section: –3 ____ +3 divisions

With 8552A IF Section: –5 ____ +5 divisions

PERFORMANCE TESTS

4-18. FREQUENCY RESPONSE (cont'd)

- Tune FREQUENCY control to frequencies noted below. At each frequency, re-adjust TRACKING GEN LEVEL for a 1.000 volt reading on first Digital Voltmeter, then note reading on second Digital Voltmeter (don't re-adjust LINEAR SENSITIVITY). Second Digital Voltmeter should read 700.0 ±16.1 mV.

Frequency	Reading
1 kHz	683.9 _____ 716.1 mV
3 kHz	683.9 _____ 716.1 mV
5 kHz	683.9 _____ 716.1 mV
10 kHz	683.9 _____ 716.1 mV
20 kHz	683.9 _____ 716.1 mV
30 kHz	683.9 _____ 716.1 mV

- Set RANGE to 0-300 kHz and tune FREQUENCY control to frequencies noted below. Again, re-adjust TRACKING GEN LEVEL for a 1.000 volt reading on first Digital Voltmeter. Second Digital Voltmeter should read 700.0 ±16.1 mV.

Frequency	Reading
50 kHz	683.9 _____ 716.1 mV
100 kHz	683.9 _____ 716.1 mV
150 kHz	683.9 _____ 716.1 mV
200 kHz	683.9 _____ 716.1 mV
250 kHz	683.9 _____ 716.1 mV
300 kHz	683.9 _____ 716.1 mV

4-19. AVERAGE NOISE LEVEL

SPECIFICATION: Specified with a 600 ohm or less source impedance and INPUT LEVEL at -60 dBm/dBV.

Mode	1 kHz IF Bandwidth	10 Hz IF Bandwidth
dBm - 50 Ω	< -122 dBm (180 nV)	< -142 dBm (18 nV)
dBm - 600 Ω	< -130 dBm (250 nV)	< -150 dBm (25 nV)
dBV	< -132 dBV (250 nV)	< -152 dBV (25 nV)
Linear	< 400 nV	< 40 nV

DESCRIPTION: Average noise level is observed on the analyzer's calibrated CRT display with no signal input and the analyzer INPUT terminated in 600 ohms.

NOTE

The 10 Hz bandwidth specification can be checked only when using an 8552B IF Section.

EQUIPMENT:

600 Ohm Feed Thru Termination HP 11095A

PROCEDURE:

- Connect 600 Ohm Feed Thru Termination to INPUT. Set the analyzer as follows:

RANGE	0-30 kHz
FREQUENCY	7 kHz
FINE TUNE	Centered
BANDWIDTH	1 kHz

PERFORMANCE TESTS

4-19. AVERAGE NOISE LEVEL (cont'd)

SCAN WIDTH	ZERO
INPUT LEVEL	-60 dBm/dBV
20 kHz MARKERS	Quit
SCAN TIME PER DIVISION	50 MILLISECONDS
LOG/LINEAR	LINEAR
LINEAR SENSITIVITY	0.1 μV/DIV
Vernier	ccw
VIDEO FILTER	10 Hz (with 8552B), 100 Hz (with 8552A)
SCAN MODE	INT
SCAN TRIGGER	AUTO
BASE LINE CLIPPER	ccw

- Observe average noise level on CRT display. It should be less than 400 nV (the 4 graticule line on the CRT represents 400 nV). Tune the analyzer to 300 kHz using FREQUENCY and RANGE controls; the average noise level should be less than 400 nV throughout the range:

LINEAR noise level: _____ 400 nV

NOTE

Average noise level is read at the mid-point of the noise on the CRT display (see Figure 4-5).

- Set LOG/LINEAR to 10 dB LOG. In turn, set dBm/dBV switch to 50 Ω dBm, dBV, and 600 Ω dBm; at each setting, tune the analyzer from 7 kHz to 300 kHz and read the average noise level. It should be as specified below:

50 Ω dBm noise level, < -122 dBm: _____ -122 dBm
 dBV noise level, < -132 dBV: _____ -132 dBV
 600 Ω dBm noise level, < -130 dBV: _____ -130 dBV

- If using an 8552B IF Section, set BANDWIDTH to 10 Hz and check average noise level from 100 Hz to 300 kHz in all four modes. It should be as specified below:

LINEAR noise level, < 40 nV: _____ 40 nV
 50 Ω dBm noise level, < -142 dBm: _____ -142 dBm
 dBV noise level, < -152 dBV: _____ -152 dBV
 600 Ω dBm noise level, < -150 dBm: _____ -150 dBm

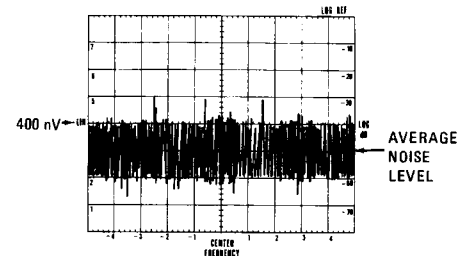


Figure 4-5. Average Noise Level Display

PERFORMANCE TESTS

4-20. RESIDUAL RESPONSES

SPECIFICATION: (No signal present at INPUT.) With the INPUT LEVEL AT -60 dBm/dBV and the input terminated with 600 ohms or less, all line related residual responses from 0 to 500 Hz are below -120 dBm/dBV. All other residual responses are below -130 dBm/dBV.

DESCRIPTION: Residual responses are signals that appear on the display with no input signal. To measure them, a reference is selected so that -120 and -130 dBm/dBV are easily determined, and the display is searched for signals appearing above this reference.

EQUIPMENT:

50 Ohm Feed Thru Termination HP 11048B

1. Connect 50 Ohm Feed Thru Termination to INPUT and set analyzer as follows:

RANGE 0–30 kHz
 FREQUENCY 0 kHz
 FINE TUNE Centered
 BANDWIDTH 100 Hz
 SCAN WIDTH PER DIVISION
 PER DIVISION 100 Hz
 INPUT LEVEL -60 dBm/dBV
 dBm/dBV 50Ω dBm
 20 kHz MARKERS Out
 SCAN TIME PER DIVISION 50 MILLISECONDS
 LOG/LINEAR 10 dB LOG
 LOG REF LEVEL -80 dBm/dBV
 Vernier ccw
 BASE LINE CLIPPER ccw
 VIDEO FILTER OFF
 SCAN MODE INT
 SCAN TRIGGER AUTO

NOTE

Instruments that radiate magnetic spurs (such as counters, power supplies, etc.) should not be operating near 8556A during this test.

2. Using FREQUENCY and FINE TUNE, tune LO feedthrough (0 Hz) to far left graticule line on CRT display (see Figure 4-6).
3. Set BANDWIDTH to 10 Hz (with 8552B IF Section) or 50 Hz (with 8552A IF Section). Set SCAN TIME PER DIVISION to 2 SECONDS.
4. Measure residual responses from the point that the skirt of the LO feedthrough crosses the -40 dB graticule on the CRT (-120 dBm) to CENTER FREQUENCY graticule (500 Hz). They should be below -120 dBm:

Line Related Residual Responses: _____ -120 dBm

NOTE

Check that peak of LO feedthrough is below -80 dBm. If it is not, null it (see Section III) and re-check line related residual responses.

PERFORMANCE TESTS

4-20. RESIDUAL RESPONSES (cont'd)

5. Check that any residual responses from 500 Hz (CENTER FREQUENCY graticule) to 1 kHz (far right graticule line) are below -130 dBm:

Residual Responses, 500 Hz to 1 kHz: _____ -130 dBm

6. Set BANDWIDTH to 30 Hz (8552B) or 50 Hz (8552A), SCAN WIDTH PER DIVISION to 2 kHz and SCAN TIME PER DIVISION to 5 SECONDS. Tune FREQUENCY to 11 kHz. All residual responses should be below -130 dBm:

Residual Responses, 1 kHz to 20 kHz: _____ -130 dBm

7. Set RANGE to 0–300 kHz and tune FREQUENCY to 30 kHz. All residual responses should be below -130 dBm:

Residual Responses, 20 kHz to 40 kHz: _____ -130 dBm

8. Tune FREQUENCY slowly to 300 kHz. All residual responses should be below -130 dBm:

Residual Responses, 40 kHz to 300 kHz: _____ -130 dBm

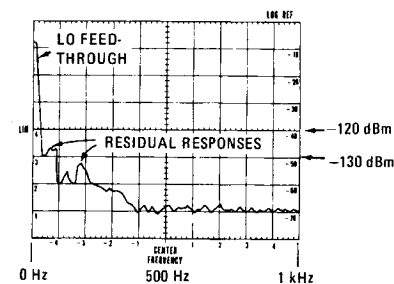


Figure 4-6. Residual Responses Display

PERFORMANCE TESTS

4-21. SPURIOUS RESPONSES

SPECIFICATION: Input signal level \leq INPUT LEVEL setting; out of band mixing responses, harmonic and intermodulation distortion products are all more than 70 dB below the input signal level 5 kHz to 300 kHz; 60 dB, 20 Hz to 5 kHz. Third order intermodulation products are more than 70 dB below the input signal level, 5 kHz to 300 kHz with signal separation $>$ 300 Hz.

DESCRIPTION: An oscillator, with low harmonic distortion, is connected through a bandpass filter, to the analyzer. Any harmonic distortion due to the analyzer is read on the CRT display. Then intermodulation distortion is checked using a two-tone test.

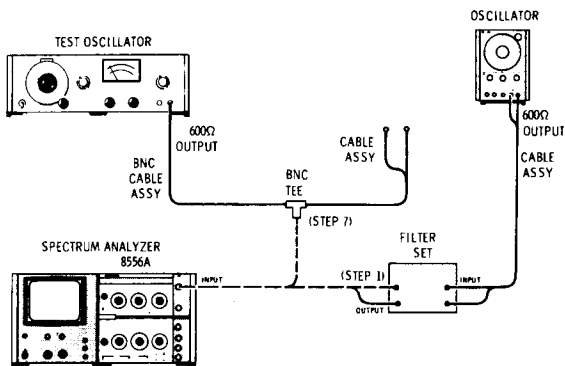


Figure 4-7. Spurious Responses Test Setup

EQUIPMENT:

Test Oscillator	HP 651B
Oscillator	HP 204D
BNC Tee	HP 1250-0781
BNC Cable Assy	HP 10503A
Cable Assy	HP 11000A
Cable Assy	HP 11001A
Filter Set	White Model 2640

PROCEDURE:

1. Connect Oscillator through Filter Set to analyzer INPUT as shown in Figure 4-7.

PERFORMANCE TESTS

4-21. SPURIOUS RESPONSES (cont'd)

2. Set analyzer as follows:

RANGE	0-300 kHz
FREQUENCY	50 kHz
FINE TUNE	Centered
BANDWIDTH	100 Hz
SCAN WIDTH	PER DIVISION
PER DIVISION	500 Hz
INPUT LEVEL	-10 dBm/dBV
dBm/dBV	dBV
20 kHz MARKERS	Out
SCAN TIME PER DIVISION	0.5 SECONDS
LOG/LINEAR	10 dB LOG
LOG REF LEVEL	-10 dBm/dBV
Vernier	ccw
BASE LINE CLIPPER	ccw
VIDEO FILTER	100 Hz
SCAN MODE	INT
SCAN TRIGGER	AUTO

3. Switch Filter Set to 50 kHz filter. Set Oscillator for a 50 kHz, CW signal at -10 dBV. Center signal on analyzer CRT display with FREQUENCY and FINE TUNE. Set signal peak to CRT LOG REF graticule with Oscillator AMPLITUDE vernier.

4. Tune FREQUENCY to 100 kHz and 150 kHz; at both frequencies all signals on CRT should be below -70 dB graticule line.

Harmonic Distortion: _____ -70 dB

5. Switch Filter Set to 500 Hz filter. Set SCAN WIDTH to 0-10f, and set Oscillator for a 500 Hz, CW signal at -10 dBV. If necessary, set signal peak to CRT LOG REF graticule with Oscillator AMPLITUDE vernier.

6. Set BANDWIDTH to 30 Hz (with 8552B) or 50 Hz (with 8552A) and set SCAN TIME PER DIVISION to 2 SECONDS. All harmonics of 500 Hz (1 kHz, 1.5 kHz, etc.) should be below -60 dB graticule line:

Harmonic Distortion: _____ -60 dB

7. Disconnect Filter Set from analyzer INPUT. Connect Test Oscillator and Oscillator to BNC Tee; connect BNC Tee directly to INPUT.

8. Set one oscillator for a 70 kHz, CW signal (f_1), and the other oscillator for a 90 kHz, CW signal (f_2). Set both oscillator output attenuators to -40 dBm.

9. Set INPUT LEVEL to -40 dBV, and SCAN WIDTH PER DIVISION to 20 kHz. Set SCAN TIME PER DIVISION to 2 SECONDS and BANDWIDTH to 300 Hz. Set both oscillator AMPLITUDE verniers so that both signal peaks are 3 dB below LOG REF graticule on CRT display.

PERFORMANCE TESTS

4-21. SPURIOUS RESPONSES (cont'd)

10. Refer to Figure 4-8; the signals at 140 kHz ($2f_1$) and 180 kHz ($2f_2$) are oscillator second harmonics. Any second order intermodulation product (due to the analyzer) will occur at 160 kHz ($f_1 + f_2$). Any third order intermodulation products will occur at 50 kHz ($2f_1 - f_2$) and at 110 kHz ($2f_2 - f_1$). The intermodulation products should all be below -70 dB graticule line:

Intermodulation Products Above 5 kHz: _____ -70 dB

11. Set one oscillator for a 1.7 kHz, CW signal (f_1), and the other oscillator for a 2 kHz, CW signal (f_2).
12. Set SCAN WIDTH PER DIVISION knob to 500 Hz, and set BANDWIDTH to 30 Hz (with 8552B IF Section) or 50 Hz (with 8552A IF Section). If necessary, tune ZERO ADJ until LO feedthrough is centered at far left graticule line.
13. If necessary, use oscillator AMPLITUDE verniers to set both signal peaks 3 dB below LOG REF graticule on CRT. The signals at 3.4 kHz ($2f_1$) and 4.0 kHz ($2f_2$) are oscillator second harmonics. Any second order intermodulation product will occur at 3.7 kHz ($f_1 + f_2$); this will always be centered between the two second harmonics. Any third order intermodulation product will occur at 1.4 kHz ($2f_1 - f_2$) and at 2.3 kHz ($2f_2 - f_1$). The intermodulation products should all be below -60 dB graticule line:

Intermodulation Products Below 5 kHz: _____ -60 dB

NOTE

With the 8552A IF Section, the close-in third order intermodulation products will be hidden in the skirts of the fundamental frequencies.

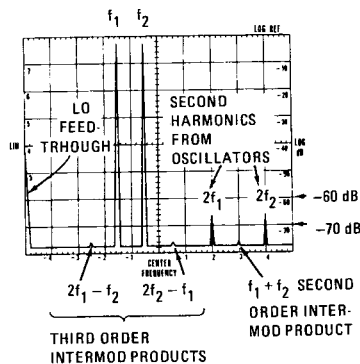


Figure 4-8. Intermodulation Distortion Products Display

PERFORMANCE TESTS

4-22. RESIDUAL FM

SPECIFICATION: With 8552B IF Section: Sidebands >60 dB down 50 Hz or more from CW signal, scan time ≥ 1 sec/div, 10 Hz bandwidth. With 8552A IF Section: Less than 20 Hz peak-to-peak.

DESCRIPTION: The test is written in two parts: the first part is for the 8552B and tests residual FM by checking a stable, CW signal for close-in sidebands. The second part is for the 8552A; the signal is slope detected on the linear portion of the IF filter skirt, then any detected FM is displayed in the time domain.

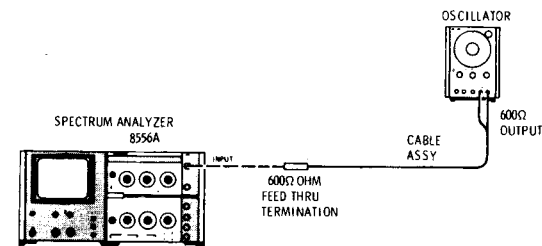


Figure 4-9. Residual FM Test Setup

EQUIPMENT:

Oscillator	HP 204D
Cable Assy	HP 11001A
600 Ohm Feed Thru Termination	HP 11095A

PROCEDURE:

1. Connect equipment as shown in Figure 4-9, connecting the oscillator to analyzer INPUT through the 600 Ohm Feed Thru Termination.

2. Set analyzer as follows:

RANGE	0-30 kHz
FREQUENCY	2 kHz
FINE TUNE	Centered
BANDWIDTH	100 Hz
SCAN WIDTH	PER DIVISION
PER DIVISION	500 Hz
INPUT LEVEL	-20 dBm/dBV
20 kHz MARKERS	Out
dBm/dBV	600Ω dBm
SCAN TIME PER DIVISION	0.1 SECONDS
LOG/LINEAR	10 dB LOG
LOG REF LEVEL	-20 dBm/dBV
VIDEO FILTER	OFF
BASE LINE CLIPPER	ccw
SCAN MODE	INT
SCAN TRIGGER	AUTO

3. Set oscillator for a 2 kHz, CW signal at -20 dBm (read on analyzer CRT). Set NORM/LOW DIST switch on oscillator rear panel to LOW DIST. If using an 8552B IF Section, proceed to step 4. If using an 8552A IF Section, skip to step 6.

PERFORMANCE TESTS

4-22. RESIDUAL FM (cont'd)

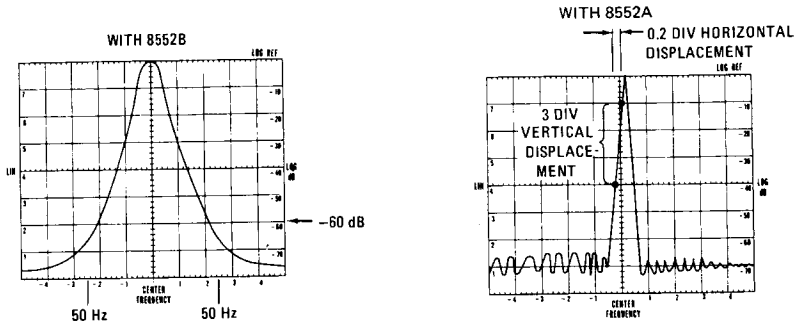


Figure 4-10. Residual FM Display

- Center signal on CRT display with FREQUENCY and FINE TUNE. Set BANDWIDTH to 10 Hz, SCAN TIME PER DIVISION to 2 SECONDS and SCAN WIDTH to 20 Hz. Re-center signal if necessary and set VIDEO FILTER to 10 Hz.
- All sidebands 2.5 divisions (50 Hz) from CENTER FREQUENCY graticule should be below -60 dB graticule line (see Figure 4-10):

60 Hz Sidebands (8552B): _____ -60 dB

- If using an 8552A, set LOG/LINEAR to LINEAR and LINEAR SENSITIVITY to 10 mV/DIV. Center signal on CRT display with FREQUENCY and FINE TUNE; set SCAN WIDTH PER DIVISION to 200 Hz and BANDWIDTH to 100 Hz.
- Using LINEAR SENSITIVITY vernier, set signal peak to top horizontal graticule line (see Figure 4-10). Then FINE TUNE so that upward slope of signal intersects CENTER FREQUENCY graticule line 1 division from the top. Note where upward slope of signal intersects middle (4) horizontal graticule line.

Horizontal Displacement: _____ divisions

- Use the horizontal displacement to calculate demodulation sensitivity:
 - Convert horizontal displacement into hertz. For example, (200 Hz SCAN WIDTH PER DIVISION) x (0.2 div) = 40 Hz.
 - Calculate demodulation sensitivity by dividing the vertical displacement in divisions into horizontal displacement in Hz. For example, $\frac{40 \text{ Hz}}{3 \text{ div}} = \frac{13.1 \text{ Hz}}{\text{div}}$
- Turn SCAN WIDTH to ZERO. Tune FREQUENCY and FINE TUNE for a response level within the calibrated three division range (from 1 division from the top to the center horizontal graticule line).
- Measure the peak-to-peak deviation and multiply it by the demodulation sensitivity obtained in step 8b above. For example, 0.5 div p-p signal deviation x 13.3 Hz/div = 6.65 Hz.

Residual FM (8552A): _____ 20 Hz

PERFORMANCE TESTS

4-23. NOISE SIDEBANDS

SPECIFICATION: More than 90 dB below CW signal, 3 kHz away from signal with a 100 Hz IF bandwidth.

DESCRIPTION: A stable CW signal is applied to the analyzer. The amplitude of the noise sidebands are measured on the CRT display.

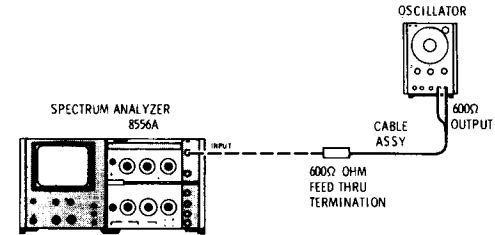


Figure 4-11. Noise Sidebands Test Setup

EQUIPMENT:

Oscillator	HP 204D
Cable Assy	HP 11001A
600 Ohm Feed Thru Termination	HP 11095A

PROCEDURE:

- Connect equipment as shown in Figure 4-11, connecting the Oscillator to analyzer INPUT through the 600 Ohm Feed Thru Termination.
- Set analyzer as follows:

RANGE	0-30 kHz
FREQUENCY	15 kHz
FINE TUNE	Centered
BANDWIDTH	100 Hz
SCAN WIDTH	PER DIVISION
PER DIVISION	2 kHz
INPUT LEVEL	-20 dBm/dBV
20 kHz MARKERS	Out
dBm/dBV	600 Ohm dBV
SCAN TIME PER DIVISION	0.5 SECONDS
LOG/LINEAR	10 dB LOG
LOG REF LEVEL	0 dBm/dBV

PERFORMANCE TESTS

4-23. NOISE SIDEBANDS (cont'd)

VIDEO FILTER	OFF
BASE LINE CLIPPER	ccw
SCAN MODE	INT
SCAN TRIGGER	AUTO

- Set Oscillator for a 15 kHz, CW signal at about 0 dBm. Center the signal on analyzer CRT display with FREQUENCY and FINE TUNE.
- Set signal peak to LOG REF graticule on CRT with Oscillator AMPLITUDE vernier. Set VIDEO FILTER to 10 Hz (with 8552B IF Section) or 100 Hz (with 8552A IF Section). Set SCAN TIME PER DIVISION to 5 SECONDS.
- Set LOG REF LEVEL to -20 dBm. Average level of noise sidebands more than 1.5 division (3 kHz) away from signal should be below -70 dB graticule (-90 dBm).

Noise Sidebands, >90 dB down: _____ -90 dBm

NOTE

Average level of noise sidebands is read at the mid-point of the noise on the CRT display (see Figure 4-12).

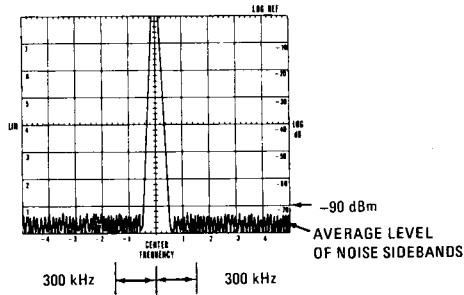


Figure 4-12. Noise Sidebands Display

PERFORMANCE TESTS

4-24. INPUT LEVEL CONTROL AND GAIN COMPRESSION

SPECIFICATIONS:

INPUT LEVEL Control: -10 to -60 dBm/dBV in 10 dB steps.

Accuracy ±0.2 dB. Marking indicates maximum input levels for 70 dB spurious-free dynamic range.

Gain Compression: For input signal level 20 dB above INPUT LEVEL setting, gain compression is less than 1 dB.

DESCRIPTION: A Test Oscillator's calibrated attenuator is used to test the accuracy of the INPUT LEVEL control. Any error is read on a Digital Voltmeter connected to the analyzer's VERTICAL OUTPUT. Next, compression is checked by setting the oscillator 20 dB above the INPUT LEVEL setting.

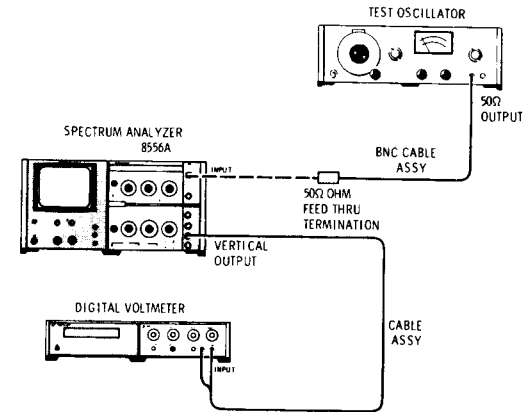


Figure 4-13. Input Level Control and Gain Compression Test Setup

EQUIPMENT:

Test Oscillator	HP 651B
Digital Voltmeter	HP 3480B/3484A, Option 042
BNC Cable Assy	HP 10503A
50 Ohm Feed Thru Termination	HP 11048B
Cable Assy	HP 11001A

PROCEDURE:

- Connect equipment as shown in Figure 4-13, connecting the Test Oscillator to INPUT through the 50 Ohm Feed Thru Termination and the Digital Voltmeter to VERTICAL OUTPUT.

PERFORMANCE TESTS

4-24. INPUT LEVEL CONTROL AND GAIN COMPRESSION (cont'd)

2. Set analyzer as follows:

RANGE	0-300 kHz
FREQUENCY	50 kHz
FINE TUNE	Centered
BANDWIDTH	10 kHz
SCAN WIDTH	PER DIVISION
PER DIVISION	1 kHz
INPUT LEVEL	-10 dBm/dBV
20 kHz MARKERS	Out
dBm/dBV	50 Ω dBm
SCAN TIME PER DIVISION	20 MILLISECONDS
LOG/LINEAR	10 dB LOG
LOG REF LEVEL	0 dBm/dBV
Vernier	ccw
VIDEO FILTER	100 Hz
BASE LINE CLIPPER	ccw
SCAN MODE	INT
SCAN TRIGGER	AUTO

- Set Digital Voltmeter on a range that will measure 700.0 mV. Set Test Oscillator OUTPUT ATTENUATOR to -10 dBm; adjust oscillator frequency to 50 kHz and amplitude controls (COARSE and FINE) for zero on dBm meter scale.
- Adjust analyzer FREQUENCY and FINE TUNE to peak signal at center of CRT display. Set SCAN WIDTH to ZERO. Adjust oscillator amplitude controls until Digital Voltmeter reads -700.0 mV.
- To test INPUT LEVEL control, set INPUT LEVEL and oscillator OUTPUT ATTENUATOR as shown below. In each case, voltmeter should read -700.0 ± 2.0 mV:

INPUT LEVEL/OUTPUT ATTENUATOR Settings	INPUT LEVEL Error
-10 dBm	Reference
-20 dBm	-698.0 _____ -702.0 mV
-30 dBm	-698.0 _____ -702.0 mV
-40 dBm	-698.0 _____ -702.0 mV
-50 dBm	-698.0 _____ -702.0 mV
-60 dBm	-698.0 _____ -702.0 mV

- To test gain compression, set analyzer INPUT LEVEL and oscillator OUTPUT ATTENUATOR to -10 dBm and adjust oscillator amplitude controls for zero on dBm meter scale.
- Set LOG/LINEAR to LINEAR and LINEAR SENSITIVITY to 20 mV/DIV; adjust LINEAR SENSITIVITY vernier for -700 mV read on Digital Voltmeter.
- Set oscillator OUTPUT ATTENUATOR to +10 dBm; set LINEAR SENSITIVITY to 0.2 V/DIV. Digital Voltmeter should read -700 ± 84 mV:

-616 _____ -784 mV

PERFORMANCE TESTS

4-25. TRACKING GENERATOR SPECTRAL PURITY

SPECIFICATIONS:
 Harmonic Signals: > 40 dB down.
 Spurious Outputs: > 50 dB down.

NOTE

Testing the analyzer's residual FM also tests the tracking generator's residual FM.

DESCRIPTION: A separate Spectrum Analyzer is used to measure the harmonic and spurious outputs from the 8556A under test.

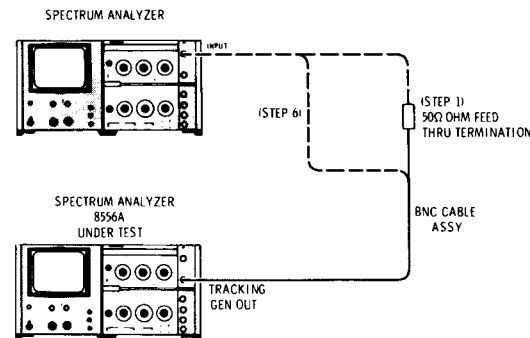


Figure 4-14. Tracking Generator Spectral Purity Test Setup

EQUIPMENT:

Spectrum Analyzer	HP 8556A/8552B/141T
50 Ohm Feed Thru Termination	HP 11048B
BNC Cable Assy	HP 10503A

NOTE

If a second spectrum analyzer is not available, an HP 310A Wave Analyzer can be used to test spectral purity.

PROCEDURE:

- Connect equipment as shown in Figure 4-14, connecting TRACKING GEN OUT of 8556A under test to INPUT of separate Spectrum Analyzer; connect through 50 Ohm Feed Thru Termination.

PERFORMANCE TESTS

4-25. TRACKING GENERATOR SPECTRAL PURITY (cont'd)

2. Set 8556A under test as follows:

RANGE 0-30 kHz
 FREQUENCY 20 kHz
 SCAN WIDTH ZERO
 TRACKING GEN LEVEL Full cw

3. Set separate Spectrum Analyzer as follows:

RANGE 0-300 kHz
 FREQUENCY 200 kHz
 FINE TUNE Centered
 BANDWIDTH 300 Hz
 SCAN WIDTH 0-10f
 PER DIVISION 20 kHz
 INPUT LEVEL -10 dBm/dBV
 20 kHz MARKERS Out
 dBm/dBV 50Ω dBm
 SCAN TIME PER DIVISION 0.5 SECONDS
 LOG/LINEAR 10 dB LOG
 LOG REF LEVEL 10 dBm/dBV
 VIDEO FILTER OFF
 SCAN MODE INT
 SCAN TRIGGER AUTO
 BASE LINE CLIPPER ccw

4. Using separate Spectrum Analyzer LOG REF LEVEL vernier, position peak of 20 kHz signal at LOG REF graticule on CRT. All harmonics of 20 kHz (40 kHz, 60 kHz, 80 kHz, etc.) should be below -40 dB graticule:

Harmonics: _____ -40 dB

5. Switch Spectrum Analyzer SCAN WIDTH to PER DIVISION. All harmonics of 20 kHz should be below -40 dB graticule:

Harmonics: _____ -40 dB

6. Switch SCAN WIDTH to 0-10f. On 8556A under test, set TRACKING GEN LEVEL to CAL 100 mV. Disconnect 50 Ohm Feed Thru from Spectrum Analyzer INPUT; connect BNC Cable Assembly directly to INPUT.

7. Set Spectrum Analyzer LOG REF LEVEL to 0 dBm and use vernier to reset peak of 20 kHz signal to LOG REF graticule on CRT.

8. All spurious signals on CRT (that is, all signals excepting LO feedthrough, 20 kHz, and 20 kHz harmonics) should be below -50 dB graticule line:

Spurious: _____ -50 dB

9. Switch SCAN WIDTH to PER DIVISION. All spurious signals should be below -50 dB graticule line:

Spurious: _____ -50 dB

Table 4-2. Performance Test Record (1 of 2)

Hewlett-Packard Model 8556A Spectrum Analyzer LF Section		Test Performed by _____			
Serial No. _____		Date _____			
Para. No.	Test Description	Measurement Units	Min.	Actual	Max.
4-14. Step: 3. 5. 7.	Tracking Generator Amplitude Amplitude Accuracy Amplitude Range Frequency Response	mV V dB	96.5 3	_____	103.5 _____ 0.5
4-15. Step: 7. 9.	Marker Accuracy Marker Accuracy (300 kHz) Marker Accuracy (280 kHz)	Hz Hz	299,970 279,972	_____	300,030 280,028
4-16. Step: 3. 5.	Scan Width Accuracy With 8552B (20 kHz/DIV) With 8552A (20 kHz/DIV) With 8552B (5 kHz/DIV) With 8552A (5kHz/DIV)	Divisions Divisions Divisions Divisions	+3.76 +3.60 +3.76 +3.60	_____	+4.24 +4.40 +4.24 +4.40
4-17. Step: 2. 3.	Center Frequency Accuracy With 8552B (0-300 kHz) With 8552A (0-300 kHz) With 8552B (0-30 kHz) With 8552A (0-30 kHz)	Divisions Divisions Divisions Divisions	-3 -5 -1 -2	_____	+3 +5 +1 +2
4-18. Step: 7. 8.	Frequency Response 1 kHz 3 kHz 5 kHz 10 kHz 20 kHz 30 kHz 50 kHz 100 kHz 150 kHz 200 kHz 250 kHz 300 kHz	mV mV mV mV mV mV mV mV mV mV mV mV	683.9 683.9 683.9 683.9 683.9 683.9 683.9 683.9 683.9 683.9 683.9 683.9	_____	761.1 761.1 761.1 761.1 761.1 761.1 761.1 761.1 761.1 761.1 761.1 761.1
4-19. Step: 2. 4.	Average Noise Level Linear (1 kHz) 50Ω dBm (1kHz) dBV (1 kHz) 600Ω dBm (1 kHz) Linear (10 Hz) 50Ω dBm (10 Hz) dBV (10 Hz) 600Ω dBm (10 Hz)	nV dBm dBV dBm nV dBm dBV dBm	_____	_____	400 -122 -132 -130 40 -142 -152 -150
4-20. Step: 4. 5. 6.	Residual Responses Line Related 500 Hz to 1 kHz 1 kHz to 20 kHz	dBm dBm dBm	_____	_____	-120 -130 -130

Table 4-2. Performance Test Record (cont'd)

Para. No.	Test Description	Measurement Units	Min	Actual	Max
4-20.	Residual Responses (cont'd)				
7.	20 kHz to 40 kHz	dBm		_____	-130
8.	40 kHz to 300 kHz	dBm		_____	-130
4-21.	Spurious Responses				
Step 4.	Harmonic Distortion (5 kHz to 300 kHz)	dB		_____	- 70
6.	Harmonic Distortion (20 Hz to 5 kHz)	dB		_____	- 60
10.	Intermod. Products Above 5 kHz	dB		_____	- 70
	Intermod. Products Below 5 kHz	dB		_____	- 60
4-22.	Residual FM				
Step 5.	60 Hz Sidebands (8552B)	dB		_____	- 60
7.	Horizontal Displacement	Divisions		_____	
10.	Residual FM (8552A)	Hz		_____	20
4-23.	Noise Sidebands				
Step 5.	Noise Sidebands	dBm		_____	- 90
4-24.	Input Level Control and Gain Compression				
Step 5.	INPUT LEVEL: -10 dBm	mV	-698.0	_____	-702.0
	-20 dBm	mV	-698.0	_____	-702.0
	-30 dBm	mV	-698.0	_____	-702.0
	-40 dBm	mV	-698.0	_____	-702.0
	-50 dBm	mV	-698.0	_____	-702.0
	-60 dBm	mV	-698.0	_____	-702.0
8.	Gain Compression	mV	-616	_____	-784
4-25.	Tracking Generator Spectral Purity				
Step 4.	Harmonics	dB		_____	- 40
5.	Harmonics	dB		_____	- 40
8.	Spurious	dB		_____	- 50
	Spurious	dB		_____	- 50

SECTION V ADJUSTMENTS

5-1. INTRODUCTION

5-2. This section describes adjustments required to return the analyzer LF Section to peak operating condition when repairs are required. Included in this section are test setups, and check and adjustment procedures. A test card for recording data is included at the back of this section. Adjustment location photographs are contained in foldouts in Section VIII.

5-3. Record data, taken during adjustments, in the spaces provided or in the data test card at the end of this section. Comparison of initial data with data taken during periodic adjustments assists in preventive maintenance and troubleshooting.

5-4. TEST EQUIPMENT REQUIRED

5-5. Tables 1-4 and 1-5 contain a tabular list of test equipment and test accessories required in the adjustment procedures. In addition, the tables contain the required minimum specifications and a suggested manufacturers model number.

5-6. In addition to the test equipment and test accessories in Tables 1-4 and 1-5, a Display Section and an IF Section are required. Perform the Display Section and IF Section adjustments prior to performing the LF Section adjustments.

5-7. Posidriv Screwdrivers

5-8. Many screws in the instrument appear to be Phillips, but are not. Table 1-5 gives the name and number of the Posidriv screwdrivers designed to fit these screws. To avoid damage to the screw slots, Posidriv screwdrivers should be used.

5-9. Blade Tuning Tools

5-10. For adjustments requiring a non-metallic metal-blade tuning tool, use the J.F.D. Model No. 5284 (HP 8710-1010). In situations not requiring non-metallic tuning tools, an ordinary small screwdriver or other suitable tool is sufficient. No matter what tool is used, never try to force any adjustment control in the analyzer. This is especially critical when tuning variable slug-tuned inductors, and variable capacitors.

5-11. HP 11592A Service Kit

5-12. The HP 11592A Service Kit is an accessory item available from Hewlett-Packard for use in

maintaining both the LF and IF Sections of the spectrum analyzer. Some adjustments can be made without this kit by removing the top cover from both the LF Section and the Display Section. However, this procedure exposes dangerous potentials in the Display Section chassis and should not be used unless absolutely necessary. All adjustments can and should be performed with the analyzer plug-ins installed on the extender cables provided in the service kit. The kit can be obtained by contacting the nearest Hewlett-Packard Sales and Service Office.

5-13. Table 1-5, Test Equipment Accessories, contains a detailed description of the contents of the service kit, and any item in the kit may be ordered separately. In the case of the 11592-60015 Extender Cable Assembly, the wiring is especially critical and fabrication should not be attempted. However, other items in the kit may be built if desired.

5-14. Extender Cable Installation

5-15. Push the front panel latch in the direction indicated by the arrow until the latch disengages and pops out from the panel. Pull the plug-ins out of the instrument. Remove the top cover of the LF Section.

5-16. Place the plate end of the HP 11592-60015 Extender Cable Assembly in the Display Section and press firmly into place so that the plugs make contact. The plate and plugs cannot be installed upside down as the plate has two holes corresponding to the two guide rods in the mainframe.

5-17. Connect the upper cable plug to the LF Section and the lower cable plug to the IF Section. The plugs are keyed so that they will go on correctly and will not make contact upside down.

5-18. FACTORY SELECTED COMPONENTS

5-19. Table 8-1 contains a list of factory selected components by reference designation, basis of selection, and schematic diagram location. Factory selected components are designated by an asterisk (*) on the schematic diagrams in Section VIII.

5-20. RELATED ADJUSTMENTS

5-21. These adjustments should be performed when the troubleshooting information in Section VIII indicates that an adjustable circuit is not

operating correctly. Perform the adjustments after repairing, or replacing, the circuit. The troubleshooting procedures specify the required adjustments.

5-22. Perform any required Display Section and IF Section adjustments before performing the LF Section adjustments. Also, perform the voltage checks in paragraph 5-23 before performing any of the following adjustments.

ADJUSTMENTS

5-23. VOLTAGE CHECKS

REFERENCE: Service Sheet 12 and IF Section and Display Section Operating and Service Manuals.

DESCRIPTION: Dc operating voltages for the LF Section are obtained from the Display Section, the IF Section, and an isolated power supply in the LF Section. If any of the operating voltages are out of limits, they should be corrected before performing any of the LF Section adjustments.

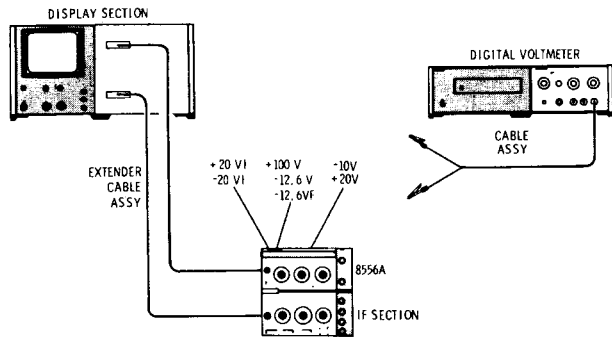


Figure 5-1. Voltage Checks Test Setup

EQUIPMENT:

Digital Voltmeter	HP 3480B/3484A Option 042
Cable Assy	HP 11002A
Extender Cable Assy	HP 11592-60015

ADJUSTMENTS

5-23. VOLTAGE CHECKS (cont'd)

PROCEDURE:

1. Extend LF and IF Sections on Extender Cable Assembly as shown in Figure 5-1.
2. Connect Digital Voltmeter from $-10V$ test point and $+20V$ test point (located on A7 assembly cover) to chassis ground. The voltages should be $-10 \pm 0.02V$ and $+20 \pm 0.10V$:

-9.98	$-10.02V$
$+19.90$	$+20.10V$
3. If either voltage is out of limits, see IF Section Operating and Service Manual.
4. Connect voltmeter from $-12.6V$ test point and $+100V$ test point (located at left, rear of Master Board Assembly A11) to chassis ground. The voltages should be $-12.6 \pm 0.2V$ and $+100 \pm 1.0V$:

-12.4	$-12.8V$
$+99.0$	$+101.0V$
5. If either voltage is out of limits, see Display Section Operating and Service Manual.
6. Connect voltmeter from $-12.6V$ test point (located at left, rear of master board) to chassis ground. (20 kHz MARKERS button on analyzer front panel should be out.) The voltage should be $-11.5 \pm 0.5V$:

-11.0	$-12.0V$
---------	----------
7. Connect voltmeter from 20 VI test point and $-20 VI$ test point (located on A5 assembly cover) to A5 assembly cover ground (not chassis ground). The voltages should be $+20 \pm 2V$ and $-20 \pm 2V$:

$+18$	$+22V$
-18	$-22V$
8. If any of the voltages checked in steps 6 and 7 are out of limits, see Service Sheet 12 in this manual.

ADJUSTMENTS

5-24. PRE-ATTENUATOR ADJUSTMENTS: COMP AND C IN

REFERENCE: Service Sheet 4.

DESCRIPTION: Pre-attenuator attenuation is checked. Then its flatness is set, adjusting COMP capacitor A5C7, so that attenuation at 300 kHz equals attenuation at 3 kHz. C IN capacitor A5C6 is adjusted so that INPUT capacitance does not change when the attenuator is used.

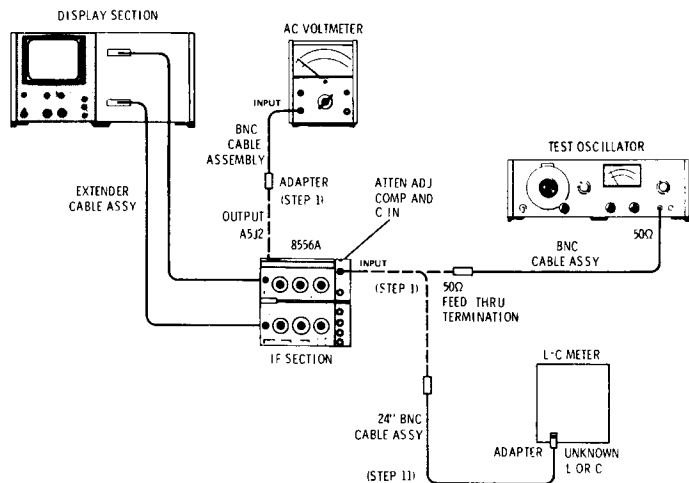


Figure 5-2. Pre-Attenuator Adjustment Test Setup

EQUIPMENT:

L-C Meter	Tektronix Type 130
Test Oscillator	HP 651B
AC Voltmeter	HP 400EL
50 Ohm Feed Thru Termination	HP 11048B
BNC Cable Assy	HP 10503A
24" BNC Cable Assy	HP 11086A
Adapter	HP 1250-1236
Adapter	HP 1250-0071
Extender Cable Assy	HP 11592-60015
Tuning Tool	HP 8710-1010

PROCEDURE:

1. Connect equipment as shown in Figure 5-2, disconnecting green cable (A3W1) so that AC Voltmeter can be connected to A5J2 (OUTPUT). Connect Test Oscillator to analyzer INPUT through 50 Ohm Feed Thru Termination.

ADJUSTMENTS

5-24. PRE-ATTENUATOR ADJUSTMENTS: COMP AND C IN (cont'd)

2. Set analyzer as follows (controls not specified do not apply):

dBm/dBV	50Ω dBm
INPUT LEVEL	-40 dBm/dBV
3. Set Test Oscillator for a 3 kHz -27 dBm signal as follows:

FREQUENCY	3.0
RANGE	X 1K
OUTPUT ATTENUATOR	-20 dBm
AMPLITUDE	-7 dBm
4. Set AC Voltmeter to measure -10 dB.
5. Adjust Test Oscillator AMPLITUDE (COARSE and FINE) so that AC Voltmeter reads -10.00 dB.
6. Set analyzer INPUT LEVEL to -30 dBm/dBV. Increase 3 kHz signal from Test Oscillator exactly 30 dB by setting OUTPUT ATTENUATOR to +10 dBm.
7. The AC Voltmeter should read -10 dB ± 0.20 dB:

-9.8	-10.2
------	-------
8. Set Test Oscillator to 300 kHz by setting RANGE to X100K (don't change oscillator signal amplitude).
9. Adjust COMP capacitor A5C7 until AC Voltmeter reads within ± 0.10 dB of reading in step 7 (taken at 3 kHz):

(step 7) ± 0.10 dB, 0.10	0.10
--------------------------	------
10. Disconnect AC Voltmeter, Test Oscillator, and 50 Ohm Feed Thru Termination from analyzer. Don't re-connect green cable (A3W1) to A5J2 (OUTPUT). Set analyzer dBm/dBV switch to dBV and input level to -40 dBm/dBV.
11. Connect the 24 inch BNC cable assembly to L-C Meter UNKNOWN L or C input, and set meter to measure 32 pF. Null cable capacitance by zeroing the meter, then connect cable to analyzer INPUT.
12. The L-C Meter should read approximately 32 pF (μF):

≈ 32 pF	
---------	--
13. Set analyzer INPUT LEVEL to -30 dBm/dBV. Adjust C IN capacitor A5C6 until L-C Meter reads within ± 0.5 pF of reading in step 12:

(step 12) ± 0.5 pF, 0.5	0.5
-------------------------	-----
14. Disconnect L-C Meter from analyzer INPUT. Re-connect green cable (A3W1) to A5J2 (OUTPUT). Perform mixer balance adjustments specified in paragraph 5-26.

ADJUSTMENTS

5-25. 50.150 MHz LOCAL OSCILLATOR ADJUSTMENT: A6T1

REFERENCE: Service Sheet 5.

DESCRIPTION: Transformer A6T1 is tuned to peak the signal from the 50.150 MHz local oscillator. Then the signal's frequency and amplitude are checked.

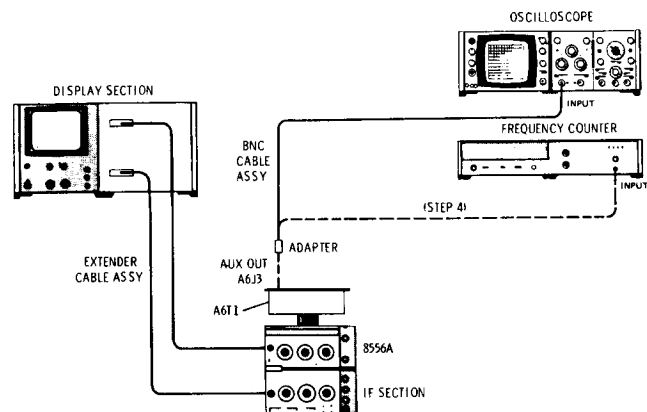


Figure 5-3. 50.150 MHz Local Oscillator Adjustment Test Setup

EQUIPMENT:

Oscilloscope	HP 180A/1801A/1820B
Frequency Counter	HP 5327C
BNC Cable Assy	HP 10503A
Adapter	HP 1250-1236
Extender Cable Assy	HP 11592-60015
Extender Board	HP 5060-0256
Tuning Tool	HP 8710-1010

PROCEDURE:

1. Connect equipment as shown in Figure 5-3. Remove Frequency Converter Assembly A6 from chassis and re-install on extender board. Connect Oscilloscope to A6J3 using BNC cable and adapter.
2. Set Oscilloscope to measure 50.150 MHz at about 1V peak-to-peak by setting TIME/DIV to 0.1 μ sec and VOLTS/DIV to 0.2V.
3. Using non-metallic tuning tool, tune transformer A6T1 for maximum signal on Oscilloscope. Signal level should be 0.9V to 1.6V peak-to-peak.

0.9 _____ 1.6V P-P

ADJUSTMENTS

5-25. 50.150 MHz LOCAL OSCILLATOR ADJUSTMENT: A6T1 (cont'd)

4. Disconnect BNC cable from Oscilloscope and connect it to Frequency Counter. Set counter to measure 50.150 MHz.
5. Oscillator frequency should be 50.150 MHz \pm 3.0 kHz:
50.147 _____ 50.153 MHz
6. Disconnect BNC cable from A6 assembly; remove extender board and install assembly into chassis. Re-connect cables to A6J1, J2 and J3. Perform mixer balance adjustments as specified in paragraph 5-26.

5-26. MIXER BALANCE ADJUSTMENTS: C, R and Z

REFERENCE: Service Sheet 5

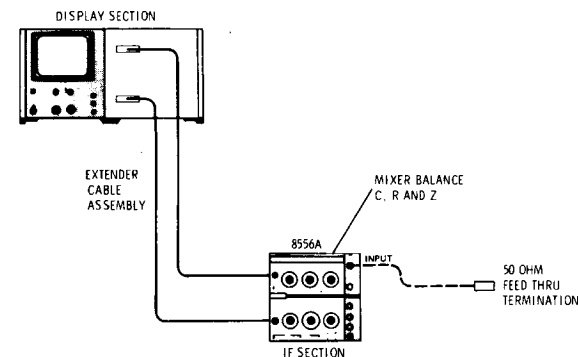
DESCRIPTION: C, R and Z MIXER BALANCE are adjusted until LO feedthrough measures less than -80 dBm.

Figure 5-4. Mixer Balance Adjustments Test Setup

EQUIPMENT:

Extender Cable Assy	HP 11592-60015
Tuning Tool	HP 8710-1010
50 Ohm Feed Thru Termination	HP 11048B

PROCEDURE:

1. Extend LF and IF Sections on Extender Cable Assembly as shown in Figure 5-4. The A6 assembly should be mounted in chassis with all screws in place. Connect 50 Ohm Feed Thru Termination to analyzer INPUT.

ADJUSTMENTS

5-26. MIXER BALANCE ADJUSTMENTS: C, R and Z (cont'd)

2. Set analyzer controls as follows:

FREQUENCY	0 kHz
BANDWIDTH	3 kHz
SCANWIDTH	PER DIVISION
PER DIVISION	10 kHz
INPUT LEVEL	-60 dBm/dBV
dBm/dBV	50Ω dBm
BASE LINE CLIPPER	ccw
VIDEO FILTER	10 kHz
SCAN TIME PER DIVISION	5 MILLISECONDS
LOG/LINEAR	10 dB LOG
LOG REF LEVEL	-40 dBm
SCAN MODE	INT
SCAN TRIGGER	AUTO

NOTE

This procedure assumes that analyzer has been allowed to warm up at least one-half hour and that it is calibrated as specified in Section III, Figure 3-2.

- Center LO feedthrough signal on display with FREQUENCY control.
- Using non-metallic adjustment tool, adjust C and R MIXER BALANCE (A6R5 and C12) for best null of LO feedthrough.
- Adjust Z MIXER BALANCE (A6C22) for LO feedthrough null, then repeat steps 4 and 5 until LO feedthrough is below -40 dB graticule on display (<-80 dBm):

_____ -80 dBm

- Secure top cover on 8556A. Repeat step 4 until LO feedthrough is below -40 dB graticule line.

_____ -80 dBm

5-27. TRACKING GENERATOR ADJUSTMENTS: AMPL ADJ and FLATNESS ADJ

REFERENCE: Service Sheet 7

DESCRIPTION: Tracking generator level is adjusted at 100 kHz, flatness is adjusted at 300 kHz, and flatness is checked across the band from 20 kHz to 300 kHz. Then the generator's ability to deliver power into a load is checked.

NOTE

The following adjustments assume that the analyzer meets its frequency specifications.

ADJUSTMENTS

5-27. TRACKING GENERATOR ADJUSTMENTS: AMPL ADJ and FLATNESS ADJ (cont'd)

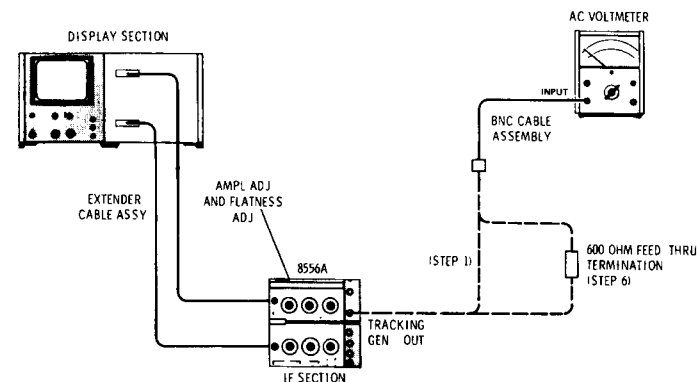


Figure 5-5. Tracking Generator Adjustment Test Setup

EQUIPMENT:

AC Voltmeter	HP 400EL
600 Ohm Feed Thru Termination	HP 11095A
24" BNC Cable Assy	HP 11086A
Tuning Tool	HP 8710-1010
Extender Cable Assy	HP 11592-60015

PROCEDURE:

- Connect equipment as shown in Figure 5-5, connecting AC Voltmeter directly to TRACKING GEN OUT with 24" BNC cable.
- Set analyzer as follows (controls not specified do not apply):

FREQUENCY	100 kHz
SCAN WIDTH	ZERO
RANGE	0-300 kHz
TRACKING GEN LEVEL	CAL 100 mV
20 kHz MARKERS	Out
- Set AC Voltmeter to read 100 mV full scale and adjust AMPL ADJ (A8A1R1) so that voltmeter reads exactly 100 mV (use non-metallic tuning tool).
- Set FREQUENCY to 300 kHz and adjust FLATNESS ADJ (A8R9) so that voltmeter reads exactly 100 mV.

ADJUSTMENTS

5-27. TRACKING GENERATOR ADJUSTMENTS: AMPL ADJ and FLATNESS ADJ (cont'd)

5. Slowly tune FREQUENCY from 300 kHz to 20 kHz. The voltmeter should indicate a maximum variation of 5 mV through entire range:

_____ 5 mV

6. Connect 600 Ohm Feed Thru Termination between TRACKING GEN OUT and AC Voltmeter. Set TRACKING GEN LEVEL full clockwise. Voltmeter should read ≥ 1.5 V:

1.5 V _____

7. Slowly tune FREQUENCY from 20 kHz to 300 kHz. The voltmeter should indicate a maximum variation of 80 mV through entire range:

_____ 80 mV

5-28. FREQUENCY CALIBRATION ADJUSTMENT: OFFSET ADJ, 300 kHz ADJ, and ZERO ADJ

REFERENCE: Service Sheet 9

DESCRIPTION: OFFSET ADJ is adjusted, and the dial is calibrated with the ZERO ADJ and 300 kHz ADJ controls.

NOTE

This procedure assumes that analyzer horizontal display calibration has been performed (see Figure 3-2 in Section III).

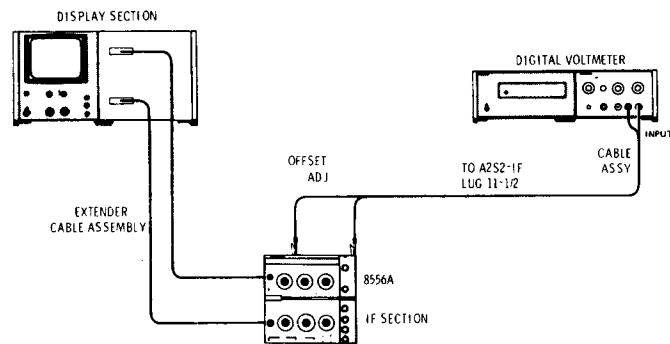


Figure 5-6. Frequency Calibration Adjustment Test Setup

EQUIPMENT

Digital Voltmeter HP 3480B/3484A Option 042
 Cable Assy HP 11002A
 Extender Cable Assy HP 11592-60015

ADJUSTMENTS

5-28. FREQUENCY CALIBRATION ADJUSTMENT: OFFSET ADJ, 300 kHz ADJ and ZERO ADJ (cont)

PROCEDURE:

1. Connect equipment as shown in Figure 5-6, connecting Digital Voltmeter between Scan Width Switch Assembly A2, wafer S2-1R lug 11½ (where white-red-gray, 928, wire is connected) and chassis ground.

2. Set analyzer controls as follows:

FREQUENCY	0 kHz
FINE TUNE	Centered
RANGE	0-300 kHz
BANDWIDTH	10 kHz
SCAN WIDTH	PER DIVISION 1 kHz
PER DIVISION	PER DIVISION 1 kHz
INPUT LEVEL	-10 dBm/dBV
BASE LINE CLIPPER	ccw
VIDEO FILTER	OFF
SCAN TIME PER DIVISION	50 MILLISECONDS
LOG/LINEAR	10 dB LOG
SCAN MODE	INT
SCAN TRIGGER	AUTO

3. Center 300 kHz ADJ, and center OFFSET ADJ (A7R13). Center LO feedthrough signal at CENTER FREQUENCY graticule with ZERO ADJ. Dial should be accurately set to 0 kHz.

4. Adjust OFFSET ADJ for 0.0 ± 5.0 mV read on voltmeter.

5. Set BANDWIDTH to 100 Hz and PER DIVISION to 100 Hz; center signal on display with ZERO ADJ. Switch RANGE to 0-30 kHz; signal shift should be less than 150 Hz:

_____ 150 Hz

6. Set BANDWIDTH to 1 kHz, PER DIVISION to 20 kHz and RANGE to 0-300 kHz; push 20 kHz MARKERS switch.

7. Slowly tune FREQUENCY to 300 kHz counting 20 kHz markers as they pass CENTER FREQUENCY graticule on display. Center fifteenth marker (300 kHz) on CENTER FREQUENCY graticule; adjust 300 kHz ADJ so that dial reads 300 kHz when fifteenth marker (300 kHz) is centered.

8. Tune FREQUENCY to 0 kHz. Adjust ZERO ADJ to center LO feedthrough (0 Hz) on display.

9. Repeat steps 7 and 8 until no further adjustment is necessary.

5-29. ANALOGIC CHECKS

REFERENCE: Service Sheet 10 and IF Section Operating and Service Manual.

DESCRIPTION: Perform the display calibration check tabulated below. If an adjustment is required, refer to the analogic adjustment procedure in the IF Section manual.

If the table indicates that the DISPLAY UNCAL light should be off, it is acceptable for the light to be on if the light subsequently goes off when either SCAN TIME PER DIVISION or SCAN WIDTH PER DIVISION is switched one position counter-clockwise.

ADJUSTMENTS

ADJUSTMENTS

5-29. ANALOGIC CHECKS (cont'd)

Table 5-1. Analogic Display Calibration Check

VIDEO FILTER	SCAN TIME PER DIVISION	BANDWIDTH	SCAN WIDTH PER DIVISION	SCAN WIDTH	DISPLAY UNCAL LIGHT
10 Hz	2 SECONDS	100 Hz	1 kHz	PER DIVISION	OFF
10 Hz	1 SECOND	100 Hz	1 kHz	PER DIVISION	ON
100 Hz	0.2 SECONDS	1 kHz	10 kHz	PER DIVISION	OFF
100 Hz	0.1 SECONDS	1 kHz	10 kHz	PER DIVISION	ON
10 kHz	10 MILLISECONDS	3 kHz	20 kHz	PER DIVISION	OFF
10 kHz	5 MILLISECONDS	3 kHz	20 kHz	PER DIVISION	ON
OFF	5 MILLISECONDS	3 kHz	20 kHz	ZERO	OFF*
OFF	2 MILLISECONDS	10 kHz	20 kHz	PER DIVISION	OFF
OFF	5 MILLISECONDS	3 kHz	20 kHz	PER DIVISION	OFF
OFF	5 MILLISECONDS	1 kHz	20 kHz	PER DIVISION	ON
OFF	20 MILLISECONDS	1 kHz	10 kHz	PER DIVISION	OFF
OFF	20 MILLISECONDS	300 Hz	10 kHz	PER DIVISION	ON
OFF	50 MILLISECONDS	300 Hz	2 kHz	PER DIVISION	OFF
OFF	50 MILLISECONDS	100 Hz	2 kHz	PER DIVISION	ON
OFF	0.1 SECONDS	100 Hz	500 Hz	PER DIVISION	OFF
OFF	0.1 SECONDS	30 Hz	500 Hz	PER DIVISION	ON
OFF	0.2 SECONDS	30 Hz	100 Hz	PER DIVISION	OFF
OFF	0.2 SECONDS	10 Hz	100 Hz	PER DIVISION	ON
OFF	0.5 SECONDS	10 Hz	20 Hz	PER DIVISION	OFF
OFF	0.5 SECONDS	300 Hz	20 Hz	PER DIVISION	OFF
OFF	0.2 SECONDS	300 Hz	20 kHz	PER DIVISION	ON
OFF	0.2 SECONDS	300 Hz	10 kHz	PER DIVISION	OFF
OFF	0.1 SECONDS	300 Hz	10 kHz	PER DIVISION	ON
OFF	0.1 SECONDS	300 Hz	5 kHz	PER DIVISION	OFF
OFF	50 MILLISECONDS	300 Hz	5 kHz	PER DIVISION	ON
OFF	50 MILLISECONDS	300 Hz	2 kHz	PER DIVISION	OFF
OFF	20 MILLISECONDS	300 Hz	2 kHz	PER DIVISION	ON
OFF	20 MILLISECONDS	300 Hz	1 kHz	PER DIVISION	OFF
OFF	10 MILLISECONDS	300 Hz	1 kHz	PER DIVISION	ON
OFF	10 MILLISECONDS	300 Hz	500 Hz	PER DIVISION	OFF
OFF	5 MILLISECONDS	300 Hz	500 Hz	PER DIVISION	ON
OFF	5 MILLISECONDS	300 Hz	200 Hz	PER DIVISION	OFF
OFF	2 MILLISECONDS	300 Hz	200 Hz	PER DIVISION	ON
OFF	2 MILLISECONDS	300 Hz	100 Hz	PER DIVISION	OFF
OFF	1 MILLISECOND	300 Hz	100 Hz	PER DIVISION	ON
OFF	1 MILLISECOND	300 Hz	50 Hz	PER DIVISION	OFF

*No exception allowed.

5-30. 8552A 47 MHz LO ADJUSTMENT

REFERENCE: Service Sheet 9 and 8552A IF Section Operating and Service Manual.

DESCRIPTION: On some HP Model 8552A Spectrum Analyzer IF Sections, long term aging may have caused the center frequency of the 47 MHz LO to drift beyond the zero adjustment range of the 8556A. If this is the case, the following simplified 47 MHz LO adjustment procedure can be used to readjust center frequency and tuning accuracy.

EQUIPMENT:

Extender Cable Assy (if not available, see step 1) HP 11592-60015
Tuning Tool HP 8710-1010

PROCEDURE:

- Extend LF and IF Sections on Extender Cable Assembly (see paragraph 5-15 for step-by-step procedure). If the Extender Cable Assembly is not available, the adjustment can be made with the LF and IF Sections installed in the Display Section:

- Remove 8552A and 8556A from Display Section.
- Remove bottom covers from Display Section and 8552A.
- Place Display Section on left side and plug 8552A and 8556A into Display Section. Be careful that 8552A does not hang up on Display Section guide rails.

CAUTION

Removing the Display Section bottom cover exposes dangerous potentials (up to 7000 volts).

- Turn analyzer on and allow to warm up at least one hour.
- Set analyzer as follows:

RANGE 0-300 kHz
FREQUENCY 100 kHz
FINE TUNE Centered
BANDWIDTH 3 kHz
SCAN WIDTH PER DIVISION
PER DIVISION 20 kHz
INPUT LEVEL -20 dBm/dBV
ZERO ADJ Centered (5 turns from stop)
300 kHz ADJ Centered
20 kHz MARKERS Out
SCAN TIME PER DIVISION 50 MILLISECONDS
LOG/LINEAR LOG
LOG REF LEVEL -10 dBm/dBV
BASE LINE CLIPPER ccw
SCAN MODE INT
SCAN TRIGGER AUTO

- If necessary, adjust HORIZONTAL POSITION and GAIN on 8552A for a 10 division horizontal trace.
- Depress 20 kHz MARKERS switch. Markers should appear at approximately every major vertical graticule line on CRT. Switch 20 kHz MARKERS switch out.

ADJUSTMENTS

5-30. 8552A 47 MHz LO ADJUSTMENT (cont'd)

6. Using non-metallic tuning tool, slowly adjust 8552A A3A2C4 (see Assembly and Adjustment Locations photo in 8552A manual) until the LO feedthrough appears on the CRT (about ± 1 turn); then adjust 8552A A3A2C4 until LO feedthrough is centered on far left graticule line (see Figure 5-7).
7. Depress 20 kHz MARKERS switch. With LO feedthrough centered on far left graticule line, markers should be evenly spaced with ninth marker (180 kHz) within ± 0.2 division (4 kHz) of the +4 graticule line. If not, adjust 8552A A5R42 TUNING RANGE and A3A2C4 until the 20 kHz markers are aligned on the graticule lines and the LO feedthrough is centered on the far left graticule line. (A5R42 varies marker spacing and A3A2C4 varies location of markers.)
8. Tune FREQUENCY to 0 kHz (FINE TUNE centered), and set SCAN WIDTH PER DIVISION to 1 kHz and SCAN TIME PER DIVISION to 5 MILLISECONDS.
9. Adjust 8552A A2A3C4 until LO feedthrough is centered within ± 2 divisions of center graticule line. Center LO feedthrough exactly on center graticule line with 8556A ZERO ADJ.
10. Tune FREQUENCY to 300 kHz. Adjust 8556A 300 kHz ADJ to center 300 kHz marker on center graticule line.
11. Turn analyzer off, remove 8552A and 8556A from Display Section, replace bottom covers, and reinstall 8556A and 8552A.

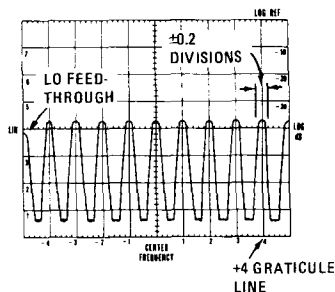


Figure 5-7. 47 MHz LO Adjustment Display

Table 5-2. Check and Adjustment Test Record

Hewlett-Packard Model 8556A Spectrum Analyzer LF Section		Test Performed by _____			
Serial No. _____		Date _____			
Para. No.	Test Description	Measurement Units	Min.	Actual	Max.
5-23.	Voltage Checks				
Step: 2.	-10 Volt Supply	Vdc	-9.98	_____	-10.02
2.	+20 Volt Supply	Vdc	+19.90	_____	+20.10
4.	-12.6 Volt Supply	Vdc	-12.4	_____	-12.8
4.	+100 Volt Supply	Vdc	+99.0	_____	+101.0
6.	-12.6 Volts Filtered	Vdc	-11.0	_____	-12.0
7.	+20 Volts Isolated	Vdc	+18	_____	+22
7.	-20 Volts Isolated	Vdc	-18	_____	-22
5-24.	Pre-Attenuator Adjustments Pre-Attenuator (30 ± 0.10 dB):				
Step: 7.	at 3 kHz	dB	-9.8	_____	-10.2
9.	at 300 kHz	dB	0.10	_____	0.10
12.	INPUT Capacitance	pF	≈ 32	_____	
13.	Pre-Attenuator Capacitance	pF	0.5	_____	0.5
5-25.	50.15 MHz Oscillator Adjustment				
Step: 3.	Signal Level	V P-P	0.9	_____	1.6
5.	Frequency	MHz	50.147	_____	50.153
5-26.	Mixer Balance Adjustment				
Step: 5.	LO Feedthrough Level	dBm		_____	-80
6.	LO Feedthrough Level	dBm		_____	-80
5-27.	Tracking Generator Adjustments				
Step: 5.	Flatness	mVrms	95	_____	105
6.	Max. Into Load	Vrms	1.5	_____	
7.	Flatness at Max.	mVrms	5	_____	5
5-28.	Frequency Calibration Adjustment				
Step: 6.	RANGE Switch Shift	Hz		_____	150

SECTION VI REPLACEABLE PARTS

6-1. INTRODUCTION

6-2. Table 6-1 is an index of reference designations and abbreviations used in Hewlett-Packard manuals.

6-3. Table 6-3 lists 8556A replaceable parts in alpha-numerical order of their reference designation.

6-4. Table 6-2 lists code number identification of part manufacturers. (Manufacturer's code and part number are supplied for each part listed in Table 6-3).

6-5. ORDERING INFORMATION

6-6. To obtain replacement parts, address order or inquiry to your local HP Sales and Service Office (see list at rear of manual for address). Identify parts by their HP part number.

6-7. To obtain a part that is not listed, include:

- a. Instrument model number.
- b. Instrument serial number.
- c. Description of the part.
- d. Function and location of the part.

Table 6-2. Reference Designators and Abbreviations used in Parts List

REFERENCE DESIGNATORS			
<p>A = assembly B = motor BT = battery C = capacitor CP = coupler CR = diode DL = delay line DS = device signaling (lamp) E = misc electronic part</p>	<p>F = fuse FL = Filter J = jack K = relay L = inductor LS = loud speaker M = meter MK = microphone MP = mechanical part</p>	<p>P = plug Q = transistor R = resistor RT = thermistor S = switch T = transformer TB = terminal board TP = test point U = integrated circuit</p>	<p>V = vacuum tube, neon bulb, photocell, etc. VR = voltage regulator W = transformer X = socket Y = crystal Z = tuned cavity, network</p>
ABBREVIATIONS			
<p>A = amperes AFC = automatic frequency control AMPL = amplifier BFO = beat frequency oscillator BE CU = beryllium copper BH = binder head BP = bandpass BRS = brass BWO = backward wave oscillator CCW = counterclockwise CER = ceramic CMO = cabinet mount only COEF = coefficient COM = common COMP = composition COMPL = complete CONN = connector CP = cadmium plate CRT = cathode-ray tube CW = clockwise DEPC = deposited carbon DR = drive ELECT = electrolytic ENCAP = encapsulated EXT = external F = farads FH = flat head FIL H = Fillister head FXD = fixed G = giga (10^9) GE = germanium GL = glass GRD = ground(ed)</p>	<p>H = henries HDW = hardware HEX = hexagonal HG = mercury HZ = hour(s) Hz = Hertz IF = intermediate freq IMPG = impregnated INCD = incandescent INCL = include(s) INS = insulation(ed) INT = internal K = kilo = 1000 LH = left hand LIN = linear taper LK WASH = lock washer LOG = logarithmic taper LPF = low pass filter M = milli = 10^{-3} MEG = meg = 10^6 MET FLM = metal film MET OX = metallic oxide MFR = manufacturer MHz = mega Hertz MINAT = miniature MOM = momentary MOS = metallized substrate MTG = mounting MY = "mylar" N = nano (10^{-9}) N/C = normally closed NE = neon NI PL = nickel plate</p>	<p>N/O = normally open NOM = nominal NPO = negative positive zero (zero temperature coefficient) NPN = negative-positive-negative NRFR = not recommended for field replacement NSR = not separately replaceable OBD = order by description OH = oval head OX = oxide P = peak PC = printed circuit PF = picofarads = 10^{-12} farads PH BRZ = phosphor bronze PHL = Philips PIV = peak inverse voltage PNP = positive-negative-positive P/O = part of POLY = polystyrene PORC = porcelain POS = position(s) POT = potentiometer PP = peak-to-peak PT = point PWW = peak working voltage RECT = rectifier RF = radio frequency RH = round head or right hand</p>	<p>RMO = rack mount only RMS = root-mean square RWV = reverse working voltage S-B = slow-blow SCR = screw SE = selenium SECT = section(s) SEMICON = semiconductor SI = silicon SIL = silver SL = slide SPG = spring SPL = special SST = Stainless steel SR = split ring STL = steel TA = tantalum TD = time delay TGL = toggle THD = thread TI = titanium TOL = tolerance TRIM = trimmer TWT = traveling wave tube μ = micro = 10^{-6} VAR = variable VDCW = dc working volts W/ = with W = watts WIV = working inverse voltage WW = wirewound W/O = without</p>

Table 6-2. Manufacturers' Code List

MFR NO.	MANUFACTURER NAME	ADDRESS	ZIP CODE
00000	U.S.A. COMMON	ANY SUPPLIER OF U.S.A.	
01121	ALLEN BRADLEY CO.	MILWAUKEE, WIS.	53204
01295	TEXAS INSTRUMENTS INC. SEMICONDUCTOR COMPONENTS DIV.	DALLAS, TEX.	75231
04713	MOTOROLA SEMICONDUCTOR PROD. INC.	PHOENIX, ARIZ.	85008
07263	FAIRCHILD CAMERA & INST. CORP. SEMICONDUCTOR DIV.	MOUNTAIN VIEW, CALIF.	94040
08664	BRISTOL CO. THE	WATERBURY, CONN.	06720
08717	SIDAN CO. THE	SUN VALLEY, CALIF.	91352
12574	GULTON IND. INC. DATA SYSTEM DIV.	ALBUQUERQUE, N.M.	87108
28480	HEWLETT-PACKARD COMPANY	PALO ALTO, CALIF.	94304
34196	STANMAYK COIL PROD. LTD.	HAMPSHIRE ONTARIO, CANADA	
56289	SPRAGUE ELECTRIC CO.	N. ADAMS, MASS.	01247
70276	ALLEN MFG. CO.	HARTFORD, CONN.	06101
71041	BOSTON GEAR WORKS DIV. W. AMERICAN ROCKWELL CORP.	QUINCY, MASS.	02171
71468	ITT CANNON ELECT. INC.	LOS ANGELES, CALIF.	90031
71590	GLOBE UNION INC. CENTRAL ARIZ.	MILWAUKEE, WIS.	53201
71744	CHICAGO MINIATURE LAMP WORKS	CHICAGO, ILL.	60640
71785	CINCH MFG. CO. DIV. TRW INC.	ELK GROVE VILLAGE, ILL.	60120
72136	ELECTRO MOTIVE MFG. CO. INC.	WILLIAMSBURG, CONN.	06226
72982	ERIE TECHNOLOGICAL PROD. INC.	ERIE, PA.	16512
73734	FEDERAL SCREW PROD. INC.	CHICAGO, ILL.	60618
74970	JOHNSON E.F. CO.	WASECA, MINN.	56093
75042	INTERNATIONAL RESISTANCE CO. INC.	PHILADELPHIA, PA.	19108
75915	LITTELFUSE INC.	DES PLAINES, ILL.	60016
76530	CINCH MONADOCK MILLS DIV. TRW INC.	CITY OF INDUSTRY, CALIF.	91746
78189	SHAKEPROOF DIV. ILLINOIS TOOL WORKS	ELGIN, ILL.	60120
78488	STACKPOLE CARBON CO.	ST. MARYS, PA.	15857
79272	CONTINENTAL-MIRT ELECTRONICS CORP.	PHILADELPHIA, PA.	19144
80131	ELECTRONIC INDUSTRIES ASSOCIATION	WASHINGTON D.C.	20006
82142	AIRCO SPEER ELECT. COMP.	DU BOIS, PA.	15801
91506	AUGAT INC.	ATTLEBORO, MASS.	02703
93332	SYLVANIA ELECTRIC PROD. INC. SEMICONDUCTOR DIV.	WOBURN, MASS.	01801
98291	SEALLECTRO CORP.	MARLOROCK, N.Y.	10544
98978	INTERNATIONAL ELECT. RESEARCH CORP.	BURBANK, CALIF.	91502
99800	DELEVAN ELECTRONICS CORP.	E. AURORA, N.Y.	14952

Table 6-3. Replaceable Parts

Reference Designation	HP Part Number	Qty	Description	Mfr Code	Mfr Part Number
A1	08556-60026	1	SWITCH ASSY: BANDWIDTH	28480	08556-60026
A1C1	1901-0025	3	DIODE: SILICON 100MA/1V	07263	FD 2387
A1R1	0757-0274	1	R:FXD MET FLM 21.25K OHM 1% 1/8W	28480	0757-0274
A1R2	0757-0465	5	R:FXD MET FLM 100K OHM 1% 1/8W	28480	0757-0465
A1R3	0698-3453	1	R:FXD MET FLM 196K OHM 1% 1/8W	28480	0698-3453
A1R4	0698-3161	2	R:FXD MET FLM 38.3K OHM 1% 1/8W	28480	0698-3161
A1R5	0698-4507	1	R:FXD MET FLM 76.8K OHM 1% 1/8W	28480	0698-4507
A1R6	0698-3161	1	R:FXD MET FLM 38.3K OHM 1% 1/8W	28480	0698-3161
A1R7	0698-4534	2	R:FXD MET FLM 300K OHM 1% 1/8W	28480	0698-4534
A1R8	0698-4521	2	R:FXD MET FLM 154K OHM 1% 1/8W	28480	0698-4521
A1R9	0698-4534	1	R:FXD MET FLM 300K OHM 1% 1/8W	28480	0698-4534
A1R10	0698-4521	1	R:FXD MET FLM 154K OHM 1% 1/8W	28480	0698-4521
A1R11	0757-0458	1	R:FXD MET FLM 51.1K OHM 1% 1/8W	28480	0757-0458
A1R12	0698-3148	1	R:FXD MET FLM 100K OHM 1% 1/8W	28480	0698-3148
A1R13	0698-4487	1	R:FXD MET FLM 25.3K OHM 1% 1/8W	28480	0698-4487
A1R14	0698-3157	3	R:FXD MET FLM 19.6K OHM 1% 1/8W	28480	0698-3157
A1S1	3100-3012	1	SWITCH: ROTARY 7 POSITION	28480	3100-3012
A2	08556-60027	1	SWITCH ASSY: SCANNING	28480	08556-60027
A2R1	0698-6296	1	R:FXD MET FLM 20.0 OHM 0.25% 1/8W	28480	0698-6296
A2R2	0698-7533	2	R:FXD MET FLM 30 OHM 0.25% 1/8W	28480	0698-7533
A2R3	0698-4190	2	R:FXD MET FLM 50 OHM 0.25% 1/8W	28480	0698-4190
A2R4	0698-7888	1	R:FXD MET FLM 22.2 OHM 0.25% 1/8W	28480	0698-7888
A2R5	0698-7532	1	R:FXD MET FLM 100 OHM 0.25% 1/8W	28480	0698-7532
A2R6	0698-7533	1	R:FXD MET FLM 30 OHM 0.25% 1/8W	28480	0698-7533
A2R7	0698-4190	1	R:FXD MET FLM 50 OHM 0.25% 1/8W	28480	0698-4190
A2R8	0698-6299	1	R:FXD MET FLM 100.4 OHM 0.25% 1/8W	28480	0698-6299
A2R9	0698-7916	1	R:FXD MET FLM 301.2 OHM 0.25% 1/8W	28480	0698-7916
A2R10	0698-6315	1	R:FXD MET FLM 503.1 OHM 0.25% 1/8W	28480	0698-6315
A2R11	0698-6302	1	R:FXD MET FLM 995 OHM 0.25% 1/8W	28480	0698-6302
A2R12	0757-0488	4	R:FXD MET FLM 909K OHM 1% 1/8W	28480	0757-0488
A2R13	0757-0488	1	R:FXD MET FLM 909K OHM 1% 1/8W	28480	0757-0488
A2R14	0757-0488	1	R:FXD MET FLM 909K OHM 1% 1/8W	28480	0757-0488
A2R15	0757-0488	1	R:FXD MET FLM 909K OHM 1% 1/8W	28480	0757-0488
A2R16	0698-3260	6	R:FXD MET FLM 464K OHM 1% 1/8W	28480	0698-3260
A2R17	0698-3260	1	R:FXD MET FLM 464K OHM 1% 1/8W	28480	0698-3260
A2R18	0698-3260	1	R:FXD MET FLM 464K OHM 1% 1/8W	28480	0698-3260
A2R19	0698-3260	1	R:FXD MET FLM 464K OHM 1% 1/8W	28480	0698-3260
A2R20	0698-3260	1	R:FXD MET FLM 464K OHM 1% 1/8W	28480	0698-3260
A2R21	0698-3260	1	R:FXD MET FLM 464K OHM 1% 1/8W	28480	0698-3260
A2R22	0698-3271	2	R:FXD MET FLM 115K OHM 1% 1/8W	28480	0698-3271
A2R23	0698-3271	1	R:FXD MET FLM 115K OHM 1% 1/8W	28480	0698-3271
A2S1	3100-3011	1	SWITCH: ROTARY DIJK CONCENTRIC	28480	3100-3011
A2S2			PART OF S1		
A3	08556-60028	1	SWITCH ASSY: INPUT LEVEL	28480	08556-60028
A3MP1	5040-0218	1	COUPLER: SWITCH SHAFT	28480	5040-0218
A3R1	0698-7915	1	R:FXD MET FLM 900.0 OHM 0.25% 1/8W	28480	0698-7915
A3R2	0698-7912	1	R:FXD MET FLM 111.1 OHM 0.25% 1/8W	28480	0698-7912
A3R3	0698-7914	1	R:FXD MET FLM 216.2 OHM 0.25% 1/8W	28480	0698-7914
A3R4	0698-7913	1	R:FXD MET FLM 146.3 OHM 0.25% 1/8W	28480	0698-7913
A3R5	2100-3107	1	R:VAR CERMET 10K OHM 10% 10CLOC 1W	28480	2100-3107
A3R6	0757-0798	1	R:FXD MET FLM 110 OHM 1% 1/2W	28480	0757-0798
A3S1	3100-3010	1	SWITCH: ROTARY 6 POSITION	28480	3100-3010
A3M1	08556-60011	1	CABLE ASSY: INPUT AMPLIFIER	28480	08556-60011
A3M2	08556-60010	1	CABLE ASSY: INPUT CONVERTER	28480	08556-60010
A3M3	08556-60014	1	CABLE ASSY: TG LEVEL	28480	08556-60014
A4			NOT ASSIGNED		
A5	08556-60005	1	BOARD ASSY: PRE-ATTENUATOR-AM	28480	08556-60005
A5	08556-20002	5	HOUSING: SHIELD	28480	08556-20002
A5	08556-20018	2	SHIELD: HOUSING	28480	08556-20018
A5C1	0180-0094	4	C:FXD ELECT 100 UF +75-10% 25VDCW	56289	300107G025D02-05M
A5C2	0160-0127	5	C:FXD CER 1.0 UF 20% 25VDCW	56289	5C13C5-CML
A5C3	0180-0094	1	C:FXD ELECT 100 UF +75-10% 25VDCW	56289	300107G025D02-05M
A5C4	0160-0127	1	C:FXD CER 1.0 UF 20% 25VDCW	56289	5C13C5-CML
A5C5	0180-2376	1	C:FXD AL ELECT 3.5 UF +50-10% 200VDCW	56289	390257
A5C6	0121-0105	2	C:VAR CER 9-35 PF NPO	28480	0121-0105
A5C7	0121-0105	1	C:VAR CER 9-35 PF NPO	28480	0121-0105
A5C8	0180-1714	1	C:FXD ELECT 330 UF 10% 6VDCW	28480	0180-1714
A5C9	0180-0291	3	C:FXD ELECT 1.0 UF 10% 35VDCW	56289	1500105XN035A2-DYS
A5C10	0160-2261	1	C:FXD CER 15 PF 5% 500VDCW	72982	301-NPO-15 PF
A5C11	0160-2257	1	C:FXD CER 10 PF 5% 500VDCW	72982	301-000-COH0-100J
A5C12	0180-1207	2	C:FXD AL ELECT 560 UF +75-10% 6VDCW	56289	3005676006DH2-05M
A5C13	0180-1819	1	C:FXD ELECT 100 UF +75-10% 50VDCW	28480	0180-1819
A5CR1	1901-0025	1	DIODE: SILICON 100MA/1V	07263	FD 2387
A5CR2	1901-0025	1	DIODE: SILICON 100MA/1V	07263	FD 2387
A5CR3	1901-0376	2	DIODE: SILICON 35V	28480	1901-0376

See introduction to this section for ordering information

Table 6-3. Replaceable Parts

Reference Designation	HP Part Number	Qty	Description	Mfr Code	Mfr Part Number
ASCRA	1901-0376		DIODE/SILICON 35V	28480	1901-0376
ASCRA	1902-0064	2	DIODE BREAKDOWN17.5V	28480	1902-0064
ASCRA	1902-0064		DIODE BREAKDOWN17.5V	28480	1902-0064
A5A1	1250-1195	5	CONNECTOR:RF SUB-MINIATURE SERIES	98291	52-053-0000
A5J2	1250-1195		CONNECTOR:RF SUB-MINIATURE SERIES	98291	52-053-0000
A5K1	0490-1011	1	RELAY:24V 125C	28480	0490-1011
A5K2	0490-0965	1	RELAY:REED 12VDC 0.5A	28480	0490-0965
A5Q1	1853-0050	5	TSTR:SI PNP	28480	1853-0050
A5Q2	1853-0050		TSTR:SI PNP	28480	1853-0050
A5Q3	1853-0050		TSTR:SI PNP	28480	1853-0050
A5Q4	1855-0372	1	TSTR:IFET 5I N-CHANNEL	28480	1855-0372
A5R1	0757-0401	9	R:FXD MET FLM 100 OHM 1/8W	28480	0757-0401
A5R2	0757-0401		R:FXD MET FLM 100 OHM 1/8W	28480	0757-0401
A5R3	0698-7922	1	R:FXD FLM 96.8K OHM 0.25% 1/8W	28480	0698-7922
A5R4	0698-7917	1	R:FXD FLM 32.4K OHM 0.25% 1/8W	28480	0698-7917
A5R5	0675-1011	1	R:FXD COMP 100 OHM 1/8W	01121	88-1011
A5R6	0757-0344	1	R:FXD MET FLM 1.00 MEGOHM 1/4W	28480	0757-0344
A5R7	0698-7920	1	R:FXD FLM 126.6 OHM 0.25% 1/8W	28480	0698-7920
A5R8	0698-7919	1	R:FXD FLM 1316.0 OHM 0.25% 1/8W	28480	0698-7919
A5R9	0698-7918	1	R:FXD FLM 799.0 OHM 0.25% 1/8W	28480	0698-7918
A5R10	0698-7921	1	R:FXD FLM 1953 OHM 0.25% 1/8W	28480	0698-7921
A5R11	0698-3150	1	R:FXD MET FLM 2.37K OHM 1/8W	28480	0698-3150
A5R12	0757-0442	1	R:FXD MET FLM 10.0K OHM 1/8W	28480	0757-0442
A5R13	0698-3162	1	R:FXD MET FLM 46.4K OHM 1/8W	28480	0698-3162
A5R14	0698-3455	3	R:FXD MET FLM 261K OHM 1/8W	28480	0698-3455
A5R15	0698-7967	1	R:FXD FLM 2.5K OHM 0.25% 1/8W	28480	0698-7967
A5R16	0698-3455	1	R:FXD MET FLM 261K OHM 1/8W	28480	0698-3455
A5R17	0698-3155	1	R:FXD MET FLM 4.64K OHM 1/8W	28480	0698-3155
A5R18	0757-0444	1	R:FXD MET FLM 12.1K OHM 1/8W	28480	0757-0444
A5R19	0757-0290	4	R:FXD MET FLM 6.19K OHM 1/8W	28480	0757-0290
A5R20	0757-0401	1	R:FXD MET FLM 100 OHM 1/8W	28480	0757-0401
A5T1	0340-0038	4	FEEDTHRU:TERMINAL	28480	0340-0038
A5T2	0340-0038		INSULATOR:BUSHING	28480	0340-0038
A5T3	0340-0038		FEEDTHRU:TERMINAL	28480	0340-0038
A5T4	0340-0039		INSULATOR:BUSHING	28480	0340-0039
A6	08556-60006	1	BOARD ASSY:FREQUENCY CONVERTER	28480	08556-60006
A6	08556-20002		HOUSING:SHIELD	28480	08556-20002
A6C1	0160-0975	2	C:FXD CER 0.001 UF 20% 75VDCW	12574	S98-001-98
A6C2	0160-0975		C:FXD CER 0.001 UF 20% 75VDCW	12574	S98-001-98
A6C3	0180-0197	4	C:FXD ELECT 2.2 UF 10% 20VDCW	56289	1300225X9020A2-DYS
A6C4	0180-0197		C:FXD ELECT 2.2 UF 10% 20VDCW	56289	1300225X9020A2-DYS
A6C5	0160-3456	23	C:FXD CER .001 UF 10% 250VDCW	56289	C067F251F102KEL2-COH
A6C6	0180-1907		C:FXD AL ELECT 560 UF +7% -10% 6VDCW	56289	3005676D06DM2-DSM
A6C7	0160-3449	1	C:FXD CER 2000 PF 10% 250VDCW	56289	C067R251F20K525-COH
A6C8	0160-2130	2	C:FXD MICA 865 PF 1% C:FXD NY 0.0027 UF 200VDCW	28480	0160-2130
A6C9	0160-0902	1	C:FXD MICA 865 PF 1% C:FXD CER 3.0-0.4 -0.25 PF 500VDCW	56289	0160-2130
A6C10	0160-2130		C:FXD MICA 865 PF 1%	28480	0160-2130
A6C11	0160-2244	4	C:FXD CER 3.0-0.4 -0.25 PF 500VDCW	28480	0160-2244
A6C12	0121-0458	1	C:VAR AIR 1.7-11.0 PF 25VDC	74970	187-103-105
A6C13	0160-2238	1	C:FXD CER 1.5 PF 900VDCW	72982	301-000-COH-159C
A6C14	0160-3456		C:FXD CER .001 UF 10% 250VDCW	56289	C067F251F102KEL2-COH
A6C15	0160-3456		C:FXD CER .001 UF 10% 250VDCW	56289	C067F251F102KEL2-COH
A6C16	0160-3456		C:FXD CER .001 UF 10% 250VDCW	56289	C067F251F102KEL2-COH
A6C17	0160-2206	1	C:FXD MICA 160 PF 5%	28480	0160-2206
A6C18	0160-2307	1	C:FXD MICA 47 PF 5%	28480	0160-2307
A6C19	0160-3456		C:FXD CER .001 UF 10% 250VDCW	56289	C067F251F102KEL2-COH
A6C20	0160-3456		C:FXD CER .001 UF 10% 250VDCW	56289	C067F251F102KEL2-COH
A6C21	0160-3456		C:FXD CER .001 UF 10% 250VDCW	56289	C067F251F102KEL2-COH
A6C22	0121-0454	1	C:VAR AIR 1.7-11.0 PF 25VDC	74970	187-106-105
A6C23	0160-2262	1	C:FXD CER 16 PF 5% 500VDCW	72982	301-000 C060 160J
A6C24	0160-3456		C:FXD CER .001 UF 10% 250VDCW	56289	C067F251F102KEL2-COH
A6C25	0160-3456		C:FXD CER .001 UF 10% 250VDCW	56289	C067F251F102KEL2-COH
A6C26	0160-3456		C:FXD CER .001 UF 10% 250VDCW	56289	C067F251F102KEL2-COH
A6C27	0160-3456		C:FXD CER .001 UF 10% 250VDCW	56289	C067F251F102KEL2-COH
A6C28	10534-8560	8	DIODE/SILICON MATCHED QUAD(NSR)	28480	10534-8560
A6C29	10534-8560		DIODE/SILICON MATCHED QUAD(NSR)	28480	10534-8560
A6C30	10534-8560		DIODE/SILICON MATCHED QUAD(NSR)	28480	10534-8560
A6C31	1902-3104	1	DIODE:BREAKDOWN 5.62V 5% CONNECTOR:RF SUB-MINIATURE SERIES	04713	S210939-110
A6C32	1250-1194	3	CONNECTOR:RECESS	28480	08443-20011
A6C33	1250-1194		CONNECTOR:RF BULKHEAD RECEPTACLE	98291	52-045-4610
A6C34	2920-0043	3	NUT:HEX 3/8-32 X 7/16 X 3/32	00000	080
A6C35	08443-20011		CONNECTOR:RECESS	28480	08443-20011
A6C36	1250-1194		CONNECTOR:RF BULKHEAD RECEPTACLE	98291	52-045-4610

See introduction to this section for ordering information

Table 6-3. Replaceable Parts

Reference Designation	HP Part Number	Qty	Description	Mfr Code	Mfr Part Number
A6J3	2930-0043		NUT:HEX 3/8-32 X 7/16 X 3/32	00000	080
A6L1	9140-0158	1	COIL:FXD RF 1 UH 10% COIL:FXD 200 UH 5% COIL:FXD 200 UH 5% COIL:CHOKO 0.47 UH 10%	99800	1025-20
A6L2	9140-0237	2	COIL:FXD 200 UH 5%	28480	9140-0237
A6L3	9140-0237		COIL:FXD 200 UH 5%	28480	9140-0237
A6L4	9100-2255	6	COIL:CHOKO 0.47 UH 10%	28480	9100-2255
A6L5	9100-2255		COIL:CHOKO 0.47 UH 10%	28480	9100-2255
A6L6	9140-0179	2	COIL:CHOKO 22.0 UH 10%	28480	9140-0179
A6L7	9140-0179		COIL:CHOKO 22.0 UH 10%	28480	9140-0179
A6L8	9100-1616	1	COIL:FXD 1.50 UH 10%	99800	14-3303W
A6L9	9100-0368	1	COIL:FXD 0.33 UH 10%	36196	14-3303W
A6Q1	1854-0019	5	TSTR:SI NPN	28480	1854-0019
A6Q2	1854-0019		TSTR:SI NPN	28480	1854-0019
A6Q3	1854-0019		TSTR:SI NPN	28480	1854-0019
A6Q4	1205-0037	1	HEAT SINK:TRANSISTOR	28480	1205-0037
A6Q5	1854-0247	2	TSTR:SI NPN	28480	1854-0247
A6R1	0757-0465		R:FXD MET FLM 100K OHM 1/8W	28480	0757-0465
A6R2	0698-3443	3	R:FXD MET FLM 287 OHM 1/8W	28480	0698-3443
A6R3	0757-0346	4	R:FXD MET FLM 10 OHM 1/8W	28480	0757-0346
A6R4	0757-0346		R:FXD MET FLM 10 OHM 1/8W	28480	0757-0346
A6R5	2100-2632	1	R:VAR FLM 100 OHM 1/2W	28480	2100-2632
A6R6	0757-0400	2	R:FXD MET FLM 90.9 OHM 1/8W	28480	0757-0400
A6R7	0757-0400		R:FXD MET FLM 90.9 OHM 1/8W	28480	0757-0400
A6R8	0757-0401	1	R:FXD MET FLM 100 OHM 1/8W	28480	0757-0401
A6R9	0757-0401		R:FXD MET FLM 100 OHM 1/8W	28480	0757-0401
A6R10	0698-0082	2	R:FXD MET FLM 464 OHM 1/8W	28480	0698-0082
A6R11	0757-0401	1	R:FXD MET FLM 100 OHM 1/8W	28480	0757-0401
A6R12	0698-0082	2	R:FXD MET FLM 1.96K OHM 1/8W	28480	0698-0082
A6R13	0757-0317	8	R:FXD MET FLM 1.33K OHM 1/8W	28480	0757-0317
A6R14	0757-0317		R:FXD MET FLM 1.33K OHM 1/8W	28480	0757-0317
A6R15	0757-0346	1	R:FXD MET FLM 10 OHM 1/8W	28480	0757-0346
A6R16	0698-3431	2	R:FXD MET FLM 23.7 OHM 1/8W	28480	0698-3431
A6R17	0757-0198	1	R:FXD MET FLM 100 OHM 1/2W	28480	0757-0198
A6R18	0757-0346	1	R:FXD MET FLM 10 OHM 1/8W	28480	0757-0346
A6R19	0757-0394	2	R:FXD MET FLM 287 OHM 1/8W	28480	0698-3443
A6R20	0698-3443		R:FXD MET FLM 287 OHM 1/8W	28480	0698-3443
A6R21	0757-0394	1	R:FXD MET FLM 51.1 OHM 1/8W	28480	0757-0394
A6R22	0698-3441	3	R:FXD MET FLM 215 OHM 1/8W	28480	0698-3441
A6R23	0757-1094	3	R:FXD MET FLM 1.47K OHM 1/8W	28480	0757-1094
A6R24	0757-1094		R:FXD MET FLM 1.47K OHM 1/8W	28480	0757-1094
A6R25	0757-0397	2	R:FXD MET FLM 68.1 OHM 1/8W	28480	0757-0397
A6R26	0698-3429	3	R:FXD MET FLM 19.6 OHM 1/8W	28480	0698-3429
A6R27	0757-0799	1	R:FXD MET FLM 121 OHM 1/2W	28480	0757-0799
A6R28	0698-0082	1	R:FXD MET FLM 464 OHM 1/8W	28480	0698-0082
A6T1	08556-80001	1	TRANSFORMER:1W	28480	08556-80001
A6T2	08556-80003	2	TRANSFORMER:1W	28480	08556-80003
A6T3	08556-80003		TRANSFORMER:1W	28480	08556-80003
A6Y1	0410-0427	1	CRYSTAL:QUARTZ 50.150 KHZ	28480	0410-0427
A7	08556-60007	1	BOARD ASSY:FREQUENCY CONTROL	28480	08556-60007
A7	08556-20002		HOUSING:SHIELD	28480	08556-20002
ATC1	0160-2055	17	C:FXD CER 0.01 UF +80-20% 100VDCW	56289	C023F101F103S22-COH
ATC2	0160-2055		C:FXD CER 0.01 UF +80-20% 100VDCW	56289	C023F101F103S22-COH
ATC3	0160-2055		C:FXD CER 0.01 UF +80-20% 100VDCW	56289	C023F101F103S22-COH
ATC4	0160-2055		C:FXD CER 0.01 UF +80-20% 100VDCW	56289	C023F101F103S22-COH
ATC5	0160-2055		C:FXD CER 0.01 UF +80-20% 100VDCW	56289	C023F101F103S22-COH
ATC6	0160-2055		C:FXD CER 0.01 UF +80-20% 100VDCW	56289	C023F101F103S22-COH
ATC7	0160-2055		C:FXD CER 0.01 UF +80-20% 100VDCW	56289	C023F101F103S22-COH
ATC8	0180-0197	2	C:FXD ELECT 2.2 UF 10% 20VDCW	56289	1300225X9020A2-DYS
ATC9	0160-3060	2	C:FXD CER 0.1 UF 20% 250VDCW	56289	1500485X903582-DYS
ATC10	0180-0116	4	C:FXD ELECT 6.8 UF 10% 35VDCW	56289	1500485X903582-DYS
ATC11	0180-0116		C:FXD ELECT 6.8 UF 10% 35VDCW	56289	1500485X903582-DYS
ATCR1	1902-3106	1	DIODE:BREAKDOWN SILICON 5.76V	28480	1902-3106
ATL1	9140-0118	2	COIL:FXD 500 UH 5%	28480	9140-0118

Table 6-3. Replaceable Parts

Reference Designation	HP Part Number	Qty	Description	Mfr Code	Mfr Part Number
A9R1	0757-0279	1	RFXD MET FLM 3.16K OHM 1% 1/8W	28480	0757-C279
A9R2	0757-0397	1	RFXD MET FLM 68.1 OHM 1% 1/8W	28480	0757-0397
A9R3	0757-0417	1	RFXD MET FLM 362 OHM 1% 1/8W	28480	0757-0417
A9R4	0757-0426	1	RFXD MET FLM 6.9 OHM 1% 1/8W	28480	0757-0426
A9R5	0698-3429	1	RFXD MET FLM 19.6 OHM 1% 1/8W	28480	0698-3429
A9R6	0757-0420	1	RFXD MET FLM 750 OHM 1% 1/8W	28480	0757-0420
A9R7	0698-3443	1	RFXD MET FLM 287 OHM 1% 1/8W	28480	0698-3443
A9R8	0698-3431	1	RFXD MET FLM 23.7 OHM 1% 1/8W	28480	0698-3431
A9R9	0757-0815	1	RFXD MET FLM 362 OHM 1% 1/2W	28480	0757-0815
A9R10	0757-0439	1	RFXD MET FLM 6.81K OHM 1% 1/8W	28480	0757-0439
A9R11	0698-3136	1	RFXD MET FLM 17.8K OHM 1% 1/8W	28480	0698-3136
A9R12	0757-0422	1	RFXD MET FLM 909 OHM 1% 1/8W	28480	0757-0422
A9R13	0757-0403	1	RFXD MET FLM 121 OHM 1% 1/8W	28480	0757-0403
A9R14	0757-0401	1	RFXD MET FLM 100 OHM 1% 1/8W	28480	0757-0401
A9R15	0698-0083	1	RFXD MET FLM 1.96K OHM 1% 1/8W	28480	0698-0083
A9R16	0698-0083	1	RFXD MET FLM 1.96K OHM 1% 1/8W	28480	0698-0083
A9R17	0698-3334	1	RFXD MET FLM 178 OHM 1% 1/2W	28480	0698-3334
A9R18	0698-4037	1	RFXD MET FLM 46.4 OHM 1% 1/8W	28480	0698-4037
A9T1	0852-6044	1	TRANSFORMER (5 PIN)	28480	0852-6044
A9T1	08443-00041	2	TEST POINT	28480	08443-00041
A9W1	08443-60064	1	CABLE ASSY	28480	08443-60064
A10	C856-60012	1	BOARD ASSY: POWER SUPPLY	28480	0856-60012
A10	0856-60008	1	MOUNTING COVER: POWER SUPPLY	28480	0856-60008
A10C1	0160-0127	1	C1FXD CER 1.0 UF 20% 25VDCM	56289	5C13C5-CML
A10C2	0160-2055	1	C1FXD CER 0.01 UF *80-20% 100VDCM	56289	C023F101F103ZS22-CDM
A10C3	0180-0116	1	C1FXD ELECT 6.8 UF 10% 35VDCM	56289	1500A85X903582-DYS
A10C4	0180-0116	1	C1FXD ELECT 6.8 UF 10% 35VDCM	56289	1500A85X903582-DYS
A10C5	0160-0127	1	C1FXD CER 1.0 UF 20% 25VDCM	56289	5C13C5-CML
A10C6	0160-0127	1	C1FXD CER 1.0 UF 20% 25VDCM	56289	5C13C5-CML
A10CR1	1901-0040	1	DIODE: SILICON 30MA 30MV	07263	FDG1088
A10CR2	1901-0040	1	DIODE: SILICON 30MA 30MV	07263	FDG1088
A10CR3	1901-0040	1	DIODE: SILICON 30MA 30MV	07263	FDG1088
A10CR4	1901-0040	1	DIODE: SILICON 30MA 30MV	07263	FDG1088
A10CR5	1901-0040	1	DIODE: SILICON 30MA 30MV	07263	FDG1088
A10CR6	1901-0040	1	DIODE: SILICON 30MA 30MV	07263	FDG1088
A10F1	2110-0001	1	FUSE: 1 AMP 250V	75915	312001
A10L1	9100-1642	1	COIL: INDUCTOR 270.0 UF 5% 28480	9100-1642	
A10L2	9140-0137	2	COIL: FXD RF 1000 UH 5% 28480	9140-0137	
A10L3	9140-0137	2	COIL: FXD RF 1000 UH 5% 28480	9140-0137	
A10Q1	1853-0012	2	TSTR: 1ST PNP 80131	2N2904A	
A10Q2	1853-0012	1	TSTR: 1ST PNP 80131	2N2904A	
A10R1	0698-7233	1	RFXD MET FLM 750 OHM 2% 1/8W	28480	0698-7233
A10R2	0757-0465	1	RFXD MET FLM 100K OHM 1% 1/8W	28480	0757-0465
A10R3	0698-3157	1	RFXD MET FLM 19.6K OHM 1% 1/8W	28480	0698-3157
A10R4	0698-3157	1	RFXD MET FLM 19.6K OHM 1% 1/8W	28480	0698-3157
A10T1	0856-80002	1	TRANSFORMER: POWER SUPPLY	28480	0856-80002
A10T1	08443-00041	1	TEST POINT	28480	08443-00041
A10XF1	2110-0260	2	CLIP: FUSE 0.250" DIA	91506	6008-32CM
A11	C856-60001	1	BOARD ASSY: MASTER	28480	0856-60001
A11C1	0160-0165	4	C1FXD MY 0.056 UF 10% 200VDCM	56289	192P56392-PTS
A11C2	0160-0165	1	C1FXD MY 0.056 UF 10% 200VDCM	56289	192P56392-PTS
A11C3	0160-0165	1	C1FXD MY 0.056 UF 10% 200VDCM	56289	192P56392-PTS
A11C4	0160-0165	1	C1FXD MY 0.056 UF 10% 200VDCM	56289	192P56392-PTS
A11C5	0180-1746	1	C1FXD ELECT 15 UF 10% 20VDCM	28480	0180-1746
A11C6	0160-3456	1	C1FXD CER .001 UF 10% 250VDCM	56289	C067F251F102KE12-CDM
A11C7	0160-2055	1	C1FXD CER 0.01 UF *80-20% 100VDCM	56289	C023F101F103ZS22-CDM
A11C8	0160-3456	1	C1FXD CER .001 UF 10% 250VDCM	56289	C067F251F102KE12-CDM
A11C9	0160-3456	1	C1FXD CER .001 UF 10% 250VDCM	56289	C067F251F102KE12-CDM
A11C10	0160-3456	1	C1FXD CER .001 UF 10% 250VDCM	56289	C067F251F102KE12-CDM
A11L1	9140-0052	1	COIL: FXD RF 3.3 MHY 28480	9140-0052	
A11L2	9100-1618	1	COIL: MOLDED CHOKO 5.60 UH 28480	9100-1618	
A11L3	9100-1618	1	COIL: MOLDED CHOKO 5.60 UH 28480	9100-1618	
A11L4	9100-1618	1	COIL: MOLDED CHOKO 5.60 UH 28480	9100-1618	
A11Q1	1854-0039	1	TSTR: 1ST NPN 80131	2N3053	
A11R1	0698-3640	1	RFXD MET OX 1.8K OHM 5% 2W 28480	0698-3640	
A11R2	0764-0018	1	RFXD MET FLM 4700 OHM 5% 2W 28480	0764-0018	
A11R3	0698-3405	2	RFXD MET FLM 422 OHM 1% 1/2W 28480	0698-3405	
A11R4	0698-3346	1	RFXD MET FLM 4.22K OHM 1% 1/2W 28480	0698-3346	
A11R5	0698-3405	1	RFXD MET FLM 422 OHM 1% 1/2W 28480	0698-3405	
A11R6	0757-0465	1	RFXD MET FLM 100K OHM 1% 1/8W 28480	0757-0465	
A11T1	0360-0124	3	TERMINAL: SOLDER LUG 28480	0360-0124	
A11T2	0360-0124	1	TERMINAL: SOLDER LUG 28480	0360-0124	
A11T3	0360-0124	1	TERMINAL: SOLDER LUG 28480	0360-0124	
A11XA5	1251-1631	2	CONN: PC 20(2X10) CONTACTS 65-716C	71785	252-10-30-310
A11XA6	1251-1631	4	CONNECTOR: PC (1 X 10) 10 CONTACT 71785	71785	252-10-30-310

See introduction to this section for ordering information

Table 6-3. Replaceable Parts

Reference Designation	HP Part Number	Qty	Description	Mfr Code	Mfr Part Number
A11XA7	1251-2034	1	CONN: PC 20(2X10) CONTACTS	76530	65-716C
A11XA8	1251-1631	1	CONNECTOR: PC (1 X 10) 10 CONTACT	71785	252-10-30-310
A11XA9	1251-1631	1	CONNECTOR: PC (1 X 10) 10 CONTACT	71785	252-10-30-310
A11XA10	1251-1631	1	CONNECTOR: PC (1 X 10) 10 CONTACT	71785	252-10-30-310
			CHASSIS PARTS		
C1	0160-3448	1	C1FXD CER 1000 PF 10% 1000VDCM	56289	C067B251F102K525-CDM
J1			PART OF W4		
P2	1251-0055	1	CONNECTOR: MALE 24 CONTACTS	28480	1251-0055
P2	0855-00002	1	SHIELD: CONNECTOR	28480	0855-00002
R3	1251-2081	1	CONNECTOR: R AND P #1 MALE CONTACT	71468	DDM-43W2-P
P3	0856-40001	1	SUPPORT: CONNECTOR	28480	0856-40001
P2			NET ASSIGNED		
S1	3101-1533	1	SWITCH: SLIDE DP3 POS. MINIATURE	78488	SS-98
W1	0856-60024	1	CABLE ASSY: UNBAL INPUT	28480	0856-60024
W2	0856-60016	1	CABLE ASSY: IF INTERFACE	28480	0856-60016
W3	0856-60015	1	CABLE ASSY: I/O INTERFACE	28480	0856-60015
W4	0856-60023	1	CABLE ASSY: T/O OUTPUT	28480	0856-60023
W5	0856-60019	1	CABLE ASSY: I/O POSITION SWITCH	28480	0856-60019
XALL	1251-2797	1	CONNECTOR: PC (2 X 15) 30 CONTACT	71785	251-15-30-400
			MISCELLANEOUS		
	0370-0102	1	KNOB: RED BAR (SCAN WIDTH)	28480	0370-0102
	0370-0114	1	KNOB: RED W/ARROW 5/8" OD 1/8" SHAFT (FINE TUNE)	28480	0370-0114
	0370-0116	1	KNOB: BLACK ROUND (FREQUENCY)	28480	0370-0116
	0370-0151	1	KNOB: ROUND FOR 0.125" DIA SHAFT (TG LEVEL)	28480	0370-0151
	3050-0004	2	WASHER: FIBRE .3125 OD	73734	NO. 1460
	8710-0864	1	WRENCH: HEX KEY	00664	116
	5040-0274	2	FOOT: PLUG-IN	28480	5040-0274
	0855-00017	1	COVER: BOTTOM	28480	0855-00017
	0856-00001	1	PANEL: REAR	28480	0856-00001
	0856-00012	1	COVER: TOP	28480	0856-00012
	0856-00013	1	DIAL: KNOB JF (8552 LOG REF LEVEL)	28480	0856-00013
	0856-00014	1	DIAL: KNOB BANDWIDTH	28480	0856-00014
	0856-00015	1	DIAL: KNOB SCAN	28480	0856-00015
	0856-00016	1	DIAL: KNOB INPUT	28480	0856-00016
	0856-00022	1	SHIELD: MAGNETIC	28480	0856-00022
	110488	1	TERMINAL: 150 OHM	28480	110488
	11095A	1	TERMINAL: 600 OHM	28480	11095A
	11660A	1	SHUNT: TG	28480	11660A

See introduction to this section for ordering information

Table 6-3. Replaceable Parts

Reference Designation	HP Part Number	Qty	Description	Mfr Code	Mfr Part Number
FRONT PANEL PARTS					
1	2100-2531		R:VAR CERMET LOK OHM 20K LIN 2W (R4 FINE TUNE)	28480	2100-2531
2	2950-0006		NUT:HEX 1/4-32 THREAD	73734	9900
3	2190-0067		WASHER:LOCK FOR 1/4" HDW	28480	2190-0067
4	08553-2029	1	BUSHING:FINE TUNE POT	28480	08553-2029
5	2100-2528		R:VAR CERMET SK OHM 10K LIN 2W (R3 FREQUENCY)	28480	2100-2528
6	1410-0088	1	BUSHING:1/4" DIA	71041	846-2
7	2950-0001		NUT:HEX BR3 NP 3/8-32 X 1/2	73734	9002
8	2190-0016		WASHER:LOCK PH BRZ NP	00000	080
9	2360-0133		SCREW:PAN HD POZI DR 6-32 X 1-1/4"	00000	080
10	2190-0007		WASHER:INT LOCK #6	28480	2190-0007
11	5020-3349	1	SHAFT:SS	28480	5020-3349
12	08553-2028	1	BUSHING:TUNING SHAFT	28480	08553-2028
13	3050-0017		WASHER:FLAT PHOS BRONZE	00000	080
14	08553-2039	1	SPUR GEAR:29T	70276	08553-2039
15	3030-0145		SCREW:SET 6-32 X 1/8" LG	70276	080
16	3030-0342		SCREW:SET 6-32 X 5/32" LG	00000	080
17	3030-0007		SCREW:SET SST 4-40 X 1/8"	00000	080
18	08553-2020	1	FLYWHEEL	28480	08553-2020
19	08553-2021	1	SHAFT:MAIN TUNING	28480	08553-2021
20	5000-0206		WIRE:FOR ANTI-BACKLASH	28480	5000-0206
21	1400-0299	1	WIRE:FOR ANTI-BACKLASH	28480	1400-0299
22	08553-2040	1	SPUR GEAR:112T	28480	08553-2040
23	0520-0127		SCREW:PAN HD POZI DR 2-56 X 3/16"	00000	080
24	08553-6034	1	GEAR AND HUB ASSY	28480	08553-6034
25	08553-2022		SPACER:GEARBOX	28480	08553-2022
26	08553-2018		PLATE:FRONT	28480	08553-2018
27	2420-0001		NUT:HEX ST NP 6-32 X 5/16 W/LOCKWASHER	78189	080
28	08556-00005		GUSSET:LEFT	28480	08556-00005
29	2360-0193		SCREW:PAN HD POZI DR 6-32 X 1/4"	00000	080
30	08553-2016	1	BUSHING:PANEL	28480	08553-2016
31	08553-2019	1	PLATE:REAR	28480	08553-2019
32	08553-00113	1	SPRING:WINDOW	28480	08553-00113
33	08556-40002	1	WINDOW:STATIONARY	28480	08556-40002
34	08556-40003	1	WINDOW:SLIDING	28480	08556-40003
35	08553-0016	1	SPRING:WINDOW	28480	08553-0016
36	08553-6029	1	PULLEY ASSY:LEFT	28480	08553-6029
37	2200-0103		SCREW:SS PHM POZI DR 4-40 X 1/4" W/LK	00000	080
38	1450-0371	1	LENS:LAMPHOLDER, AMBER	08717	102-A (LENS)
39	1450-0153	1	LAMPHOLDER:FOR T-1 SERIES	08717	102SR
40	08556-20003	1	EXTRUSION:ENGR AWD	28480	08556-20003
41	08553-6030	1	PULLEY ASSY:RIGHT	28480	08553-6030
42	8200-0049	1	DIAL CORD	28480	8200-0049
43	1460-0195	1	SPRING:EXTENSION	28480	1460-0195
44	2360-0153		SCREW:PAN HD POZI DR 6-32 X 1/4"	00000	080
45	08553-4001	1	POINTER	28480	08553-4001
46	00197-47403	2	BUTTON:DETENT	28480	00197-47403
47	1460-0199	1	SPRING:EXTENSION	28480	1460-0199
48	2100-3066	2	R:VAR WM SK OHM 5K LIN 1W (10T) (R6 ZERO ADJ)	28480	2100-3066
49	08556-00007	1	BRACKET:POT	28480	08556-00007
50	2100-2487	1	R:VAR COMP 500 OHM 20K LIN 1/2W (R5 300KHZ ADJ)	28480	2100-2487
51	08556-00006	1	SUB-PANEL	28480	08556-00006
52	2360-0200		SCREW:FLAT HD POZI DR 6-32 X 1/2"	00000	080
53	2100-2488	1	R:VAR COMP LOK OHM 20K LIN 1/2W (R7 AMPL CAL)	28480	2100-2488
54	2140-0259	1	LAMP:INCANDESCENT 12V 0.06A	71744	CN8-1099
55	2100-3066		{DS1} R:VAR WM SK OHM 5K LIN 1W (10T) (R1 TRACK ADJ)	28480	2100-3066
56	08553-0009	1	BRACKET:POT	28480	08553-0009
57	2200-0165		SCREW:FLAT HD POZI DR 4-40 X 1/4"	00000	080
58	08556-00004	1	GUSSET:RIGHT	28480	08556-00004
59	3101-0070	1	SWITCH:SLIDE	79727	6-126
60	3101-1933	2	{S3 RANGE KHZ} SWITCH:SLIDE DP3 POS. MINIATURE {S1 DRW/DBV}	78488	SS-93
61	08556-00009	1	PLATE:CONNECTOR	28480	08556-00009
62	08556-00002	1	PANEL:FRONT	28480	08556-00002
63		1	NOT ASSIGNED		
64	3101-1299	1	SWITCH:PUSHBUTTON DPDT(S2 20KHZ MARKER)	71590	P8-1
65		1	NOT ASSIGNED		
66	08556-20013	1	KNOB:PUSH	28480	08556-20013
67	08556-20014	1	KNOB:TURN	28480	08556-20014

See Introduction to this section for ordering information

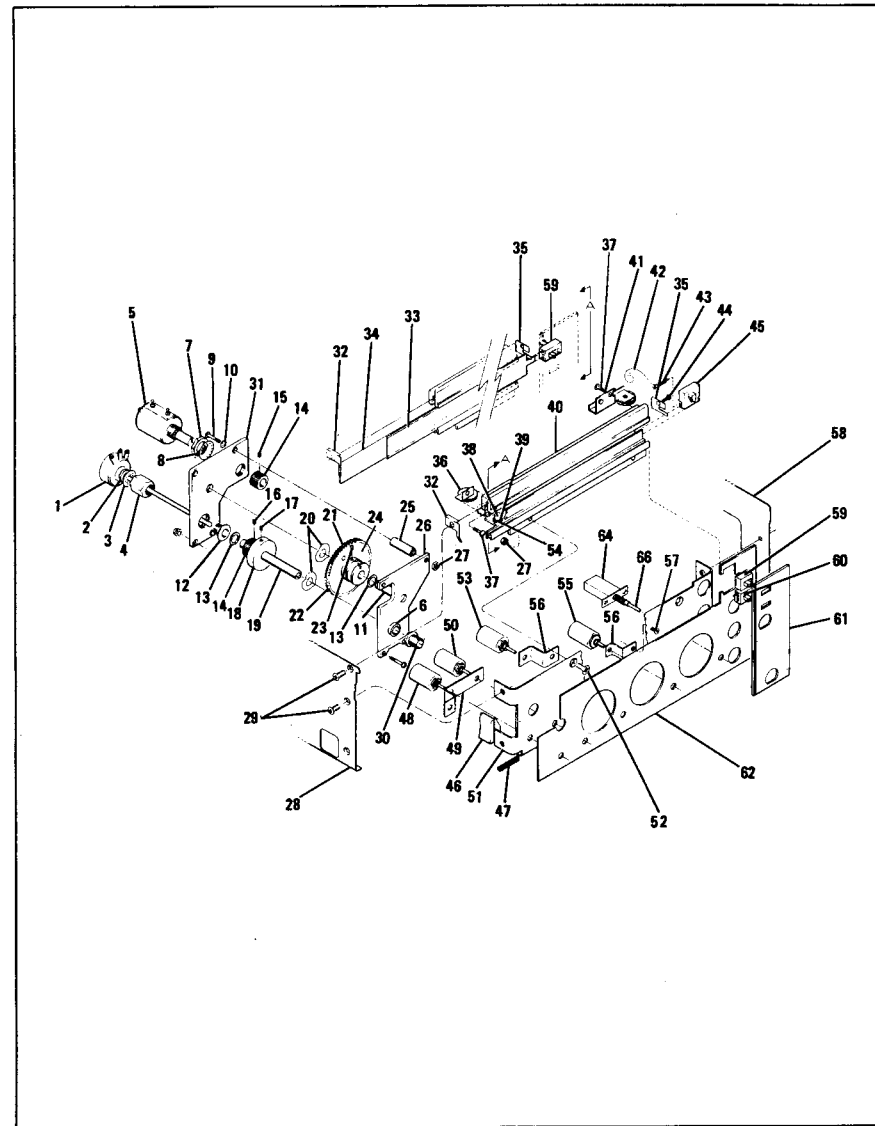


Figure 6-1. Front Panel Parts - Exploded View

SECTION VIII

SERVICE

8-1. INTRODUCTION

8-2. This section provides instructions for troubleshooting and repairing the Hewlett-Packard Model 8556A Spectrum Analyzer LF Section.

8-3. Theory of Operation

8-4. Theory of operation appears on the foldout pages opposite the block diagram on Service Sheet 2 and on the pages opposite the schematic diagrams on Service Sheets 3 through 12. The block diagram on Service Sheet 2 is keyed to the remaining service sheets so that the reader may quickly locate the schematic and theory concerning any specific circuit.

8-5. Recommended Test Equipment

8-6. Test equipment and test equipment accessories required to maintain the LF Section are listed in Tables 1-4 and 1-5. Equipment other than that listed may be used if it meets the listed minimum specifications.

8-7. Board level troubleshooting without Extender Cable Assembly HP 11592-60015 is not recommended. Component level troubleshooting and repair without the extender cable, Interconnection Cable Assembly HP 11592-60016, and the Extender Board HP 5060-0256 is not recommended. Selectro to BNC adapters HP 1250-1236 and HP 1250-1237 facilitate testing signal levels and wave-shapes but are not absolutely necessary. (The TRACKING GEN OUT cable — red — can be used as a Selectro Plug to BNC adapter.)

8-8. Troubleshooting

8-9. The troubleshooting procedures in this manual fall into three categories.

8-10. The troubleshooting tree is designed to isolate trouble to the board or assembly level.

8-11. The troubleshooting block diagram is designed to be used as a quick reference by the technician who is familiar with the LF Section and does not wish to go through the troubleshooting-tree. It will also isolate trouble to the board or assembly level.

8-12. Circuit level troubleshooting and analysis is provided on the foldout page opposite each sche-

matic. After the cause of a trouble has been isolated and corrected, check the troubleshooting information associated with that circuit for any adjustments that may have to be performed.

8-13. GENERAL SERVICE INFORMATION

8-14. Part Location Aids

8-15. The locations of chassis-mounted parts and major assemblies are shown in Figure 8-14. The locations of individual components mounted on printed circuit boards or other assemblies are shown on the appropriate schematic diagram page or on the page opposite it. The part reference designator is the assembly designator plus the part designator. (Example: A10R9 is R9 on the A10 assembly.) For specific component description and ordering information refer to the parts list in Section VI.

8-16. Factory Selected Components

8-17. Some component values are selected at the time of final checkout at the factory (see Table 8-1). Usually these values are not extremely critical; they are selected to provide optimum compatibility with associated components. These components are identified on individual schematics by an asterisk (*). The recommended procedure for replacing a factory-selected part is as follows:

a. Try the original value, then perform the calibration test specified for the circuit in the performance and adjustment sections of this manual.

b. If calibration cannot be accomplished, try the typical value shown in the parts list and repeat the test.

c. If the test results are still not satisfactory, substitute various values within the tolerances specified in Table 8-1 until the desired result is obtained.

8-18. Diagram Notes

8-19. Table 8-3, Schematic Diagram Notes, provides information relative to symbols and measurement units shown in schematic diagrams.

Table 8-1. Factory Selected Components

Component	Location	Range of Values	Basis of Selection
A1R1	Service Sheet 9	1.33K to 1.21K ohms	Sets upper limit of 300 kHz ADJ. Select for +15.85 V at test point A (A11XA7 pin 5) with analyzer set as follows: RANGE 0-300 kHz FREQUENCY .. 300 kHz FINE TUNE ... centered 300 kHz ADJ full cw
A8A1L3	Service Sheet 7	56.0 to 47.0 μ H	Sets center of tuning range of TRACK ADJ. Select for range of 3 MHz \pm 140 Hz of 3 MHz oscillator. (Increasing value of A8A1L3 will lower center of tuning range.)
A8R7	Service Sheet 7	38.0 to 42.2 ohms	Sets gain of A8Q1 at 300 kHz. Selected so that FLATNESS ADJ A8R9 can adjust flatness within limits.

8-20. Servicing Aids on Printed Circuit Boards

8-21. The servicing aids include test points, transistor and integrated circuit designations, adjustment callouts and assembly stock numbers.

8-22. Circuit Board Extender

8-23. A 20-pin extender board, HP 5060-0256 is required to extend the circuit boards clear of the chassis. This provides easy access to components and test points. See Figure 8-1 for a typical example of extender board use.

8-24. GENERAL SERVICE HINTS

8-25. Etched Circuits

8-26. The etched circuit boards in the LF Section are of the plated-through type consisting of metallic conductors bonded to both sides of insulating material. The metallic conductors are extended through the component mounting holes by a plating process. Soldering can be done from either side of the board with equally good results. Table 8-2 lists recommendations and precautions pertinent to etched circuit repair work.

a. Avoid unnecessary component substitution; it can result in damage to the circuit board and/or adjacent components.

8-2

b. Do not use a high-power soldering iron on etched circuit boards. Excessive heat may lift a conductor or damage the board.

c. Use a suction device (Table 8-2) or wooden toothpick to remove solder from component mounting holes. DO NOT USE A SHARP METAL OBJECT SUCH AS AN AWL OR TWIST DRILL FOR THIS PURPOSE. SHARP OBJECTS MAY DAMAGE THE PLATED-THROUGH CONDUCTOR.

d. After soldering, remove excess flux from the soldered areas and apply a protective coating to prevent contamination and corrosion. See Table 8-2 for recommendation.

8-27. Etched Conductor Repair

8-28. A broken or burned section of conductor can be repaired by bridging the damaged section with a length of tinned copper wire. Allow adequate overlay and remove any varnish from etched conductor before soldering wire into place.

8-29. Component Replacement

8-30. Remove defective component from board.

NOTE

Axial lead components, such as resistors and tubular capacitors, can be replaced without unsoldering. Clip leads near body of defective component, remove component and straighten leads left in board. Wrap leads of replacement component one turn around original leads. Solder wrapped connection, and clip off excess lead.

8-31. If component was unsoldered, remove solder from mounting holes, and position component as original was positioned. DO NOT FORCE LEADS INTO MOUNTING HOLES; sharp lead ends may damage plated-through conductor.

8-32. Transistor Replacement. Transistors are packaged in many physical forms. This sometimes results in confusion as to which lead is the collector, which is the emitter, and which is the base. Figures 8-2 and 8-3 show typical epoxy and metal case transistors and integrated circuits and the means of identifying the leads.

8-33. To replace a transistor, proceed as follows:

a. Do not apply excessive heat; see Table 8-2 for recommended soldering tools.

b. If possible, use long-nose pliers between transistor and hot soldering iron as a heat sink. The

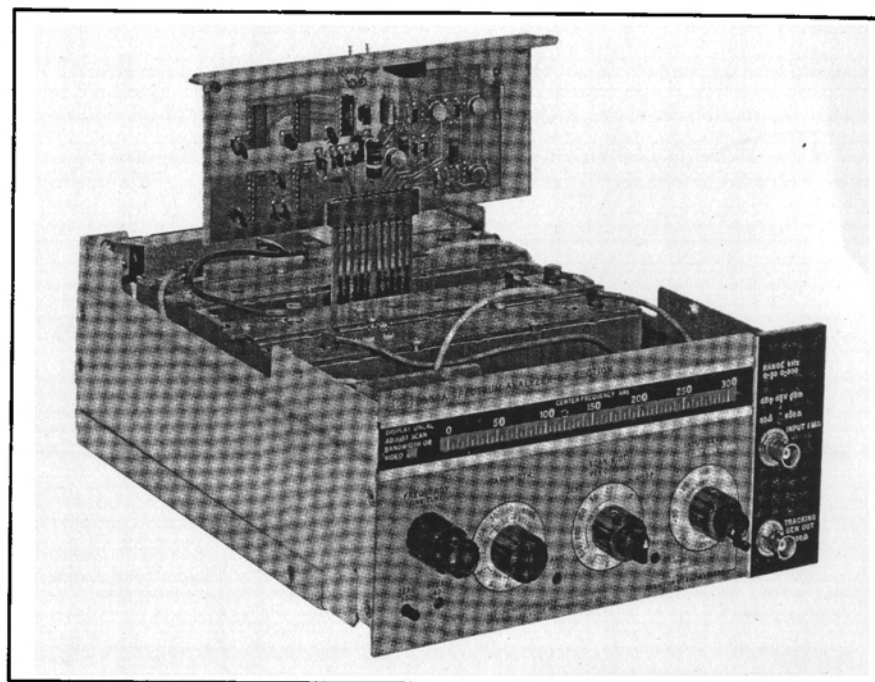


Figure 8-1. 8556A LF Section with Circuit Board Extended

instant solder is melted, use desoldering aid to remove solder from mounting hole.

c. When installing replacement transistor, ensure sufficient lead length to dissipate soldering heat by using about the same length of exposed lead as useful for original transistor.

d. Integrated circuit replacement instructions are the same as those for transistors.

8-34. Some transistors are mounted on heat sinks for good heat dissipation. This requires good thermal contact with mounting surfaces. To assure good thermal contact for a replacement transistor, coat both sides of the insulator with Dow Corning No. 5 silicone compound or equivalent before fastening the transistor to the chassis. Dow Corning No. 5 compound is available in 8 oz. tubes from Hewlett-Packard; order HP Part No. 8500-0059.

8-35. Diode Replacement. Solid state diodes are in many physical forms. This sometimes results in

confusion as to which lead or connection is the cathode (negative) and which lead is the anode (positive), since not all diodes are marked with the standard symbols. Figure 8-2 shows examples of some diode marking methods. If doubt exists as to polarity, an ohmmeter may be used to determine the proper connection. It is necessary to know the polarity of the ohms lead with respect to the common lead for the ohmmeter used. (For the HP Model 410B Vacuum Tube Voltmeter, the ohms lead is negative with respect to the common; for the HP Model 412A DC Vacuum Tube Voltmeter, the ohms lead is positive with respect to the common.) When the ohmmeter indicates the least diode resistance, the cathode of the diode is connected to the ohmmeter lead which is negative with respect to the other lead.

NOTE

Replacement instructions are the same as those listed for transistor replacement.

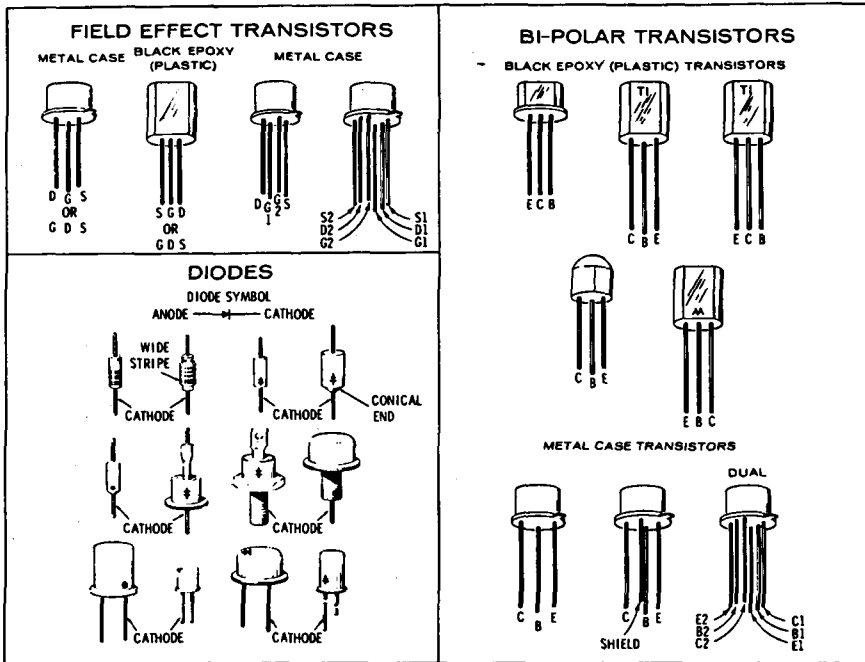


Figure 8-2. Examples of Diode and Transistor Marking Methods

Table 8-2. Etched Circuit Soldering Equipment

ITEM	USE	SPECIFICATION	ITEM RECOMMENDED
Soldering tool	Soldering, unsoldering	Wattage rating: 37-50; Tip Temp: 750-800°	Unger #766 handle w/*Unger #1237 heating unit
Soldering Tip	Soldering, unsoldering	*Shape: pointed	*Unger # PL111
De-soldering Aid	To remove molten solder from connection	Suction device	Soldapull by Edsyn Co., Arleta, California
Resin (flux) Solvent	Remove excess flux from soldered area before application of protective coating	Must not dissolve etched circuit base board	Freon; Acetone; Lacquer Thinner
Solder	Component replacement Circuit board repair Wiring	Resin (flux) core, high tin content (60/40 tin/lead), 18 gauge (SWG) preferred	
Protective Coating	Contamination, corrosion protection	Good electrical insulation, corrosion-prevention properties	Silicone Resin such as GE DRI-FILM**88

*For working on 8556A Boards: for general purpose work, use Unger No. 4037 Heating Unit (47W-56W) tip temperature of 850-900 degrees and Unger No. PL113 1/8" chisel tip.

**General Electric Co., Silicone Products Dept., Waterford, New York, U.S.A.

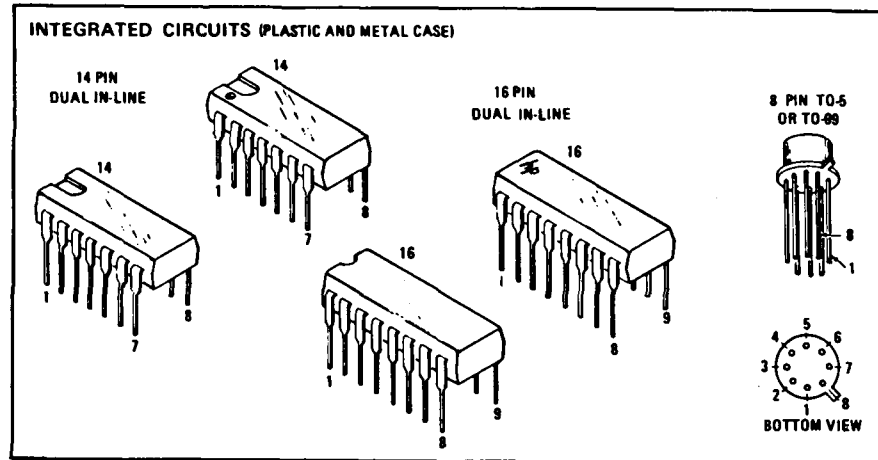


Figure 8-3. Integrated Circuit Packaging

8-36. LOGIC CIRCUITS AND SYMBOLS

8-37. The following paragraphs and illustrations provide basic information about logic circuits and symbols. While a complete treatment of the subject is not within the scope of this manual, it is believed that this material will help the technician experienced with analog devices, who has had little or no experience with digital circuits.

high and low states are relative; low must be less positive (more negative) than high, both states may be positive or negative, or high may be positive and low negative. In positive logic the more positive (H) state is a logical "1" and the more negative (L) state is a logical "0". In negative logic the more negative (L) state is a logical "1" and the more positive (H) state is a logical "0".

8-38. The circuits discussed are digital in nature; their outputs are always in one of two possible states, a "1" or "0". These two states are also referred to as being either high (H) or low (L). The

8-39. Two of the basic "building blocks" of logic circuits are the AND and OR gates. The symbols and truth tables for basic AND and OR gates are shown in Figure 8-4.

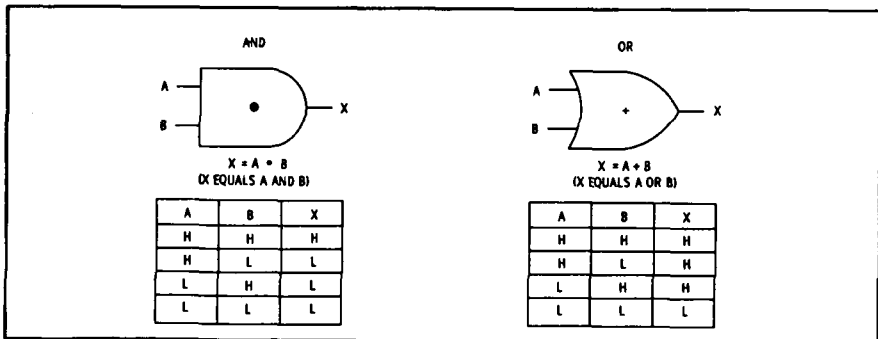


Figure 8-4. Basic AND and OR Gates

8-40. Basic AND Gate (Positive Logic)

8-41. The basic AND gate is a circuit which produces an output "1" when, and only when, a "1" is applied to all inputs. As shown in Figure 8-4, terminal X will be high only when terminals A and B are both high. The dot (•) shown in the AND gate is the logic term for AND. The term for a simple two input AND gate is $X = A \cdot B$ (X equals A and B). AND gates may be designed to have as many inputs as required to fill a specific requirement.

8-42. Basic OR Gate (Positive Logic)

8-43. The basic OR gate is a circuit which produces a "1" output when any one or all of the inputs are in the "1" state. As shown in Figure 8-4, terminal X will be high when either terminal A or terminal B, or both are high. The + shown in the OR gate symbol is the logic term for OR. The term for a simple two input OR gate is $X = A + B$ (X equals A or B). OR gates may be designed to have as many inputs as required for specific needs.

8-44. The symbols for AND and OR gates differ in that AND gates symbols have a flat input side and a rounded output side while OR gate symbols have a concave input side and a pointed output side.

8-45. Truth Tables

8-46. Truth tables provide a means of presenting, in tabular form, the output state of logic devices for any set of inputs. Truth tables contain one column for each of the inputs and a column for the output. In basic truth tables the column notations are usually H or L (for high and low) or, for binary notation, "1" or "0".

8-47. Logic Inversion

8-48. Adding inversion to AND and OR gates changes their characteristics. Inversion is usually accomplished by adding an inverter stage (common emitter) in front of an input or after an output. A circle is added to the input or output leads of the symbol to indicate the portion of the circuit in which the inversion takes place. The simplest of these devices are AND and OR gates in which the output is inverted. These gates are called NAND (for Not AND) and NOR (for Not OR). Basic NAND and NOR gates are shown in Figure 8-5. When all inputs and outputs of an AND gate are inverted, it functions as an OR gate. When all inputs and outputs of an OR gate are inverted, it functions as an AND gate. Figure 8-6 provides information relative to various gate inversion functions.

8-49. BINARY CIRCUITS AND SYMBOLS

8-50. Many types of flip-flops are used in binary circuits. Each half of a flip-flop is in one of two states at any given time. The outputs are complementary; when one stage is on, the other is off. The text identifies these outputs as Q and \bar{Q} . The outputs are termed 1 and 0, high and low, or true and false, by the same rules that apply to AND and OR gates.

8-51. Reset-Set (RS) Flip-Flop

8-52. Figure 8-7 shows an RS flip-flop. The RS flip-flop has two inputs, S for set and R for reset (sometimes labeled S for set and C for clear). Assume that initially Q is high (Q2 off) and \bar{Q} is low (Q1 on). In this state the flip-flop is set and a

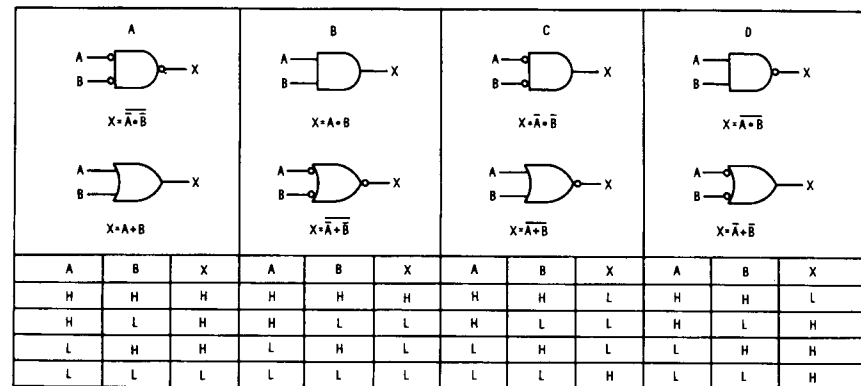


Figure 8-6. Logic Comparison Diagrams

positive pulse at the set input will not affect the circuit. When a positive pulse is applied to the reset input it is coupled through C4 and CR2 to the base of Q2. Q2 begins to conduct and the negative going collector voltage is coupled through C3 to the base

of Q1 to cut off Q1. The process is regenerative; Q1 is quickly cut off and Q2 saturates. The flip-flop will remain in the reset state until a positive set pulse is applied through C2 and CR1 to the base of Q1.

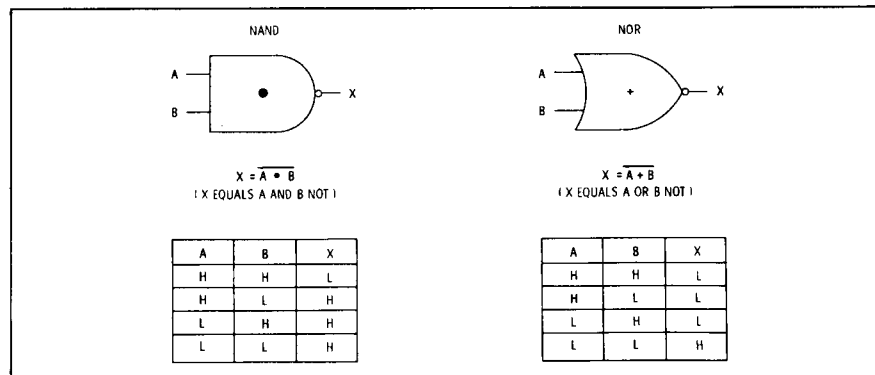


Figure 8-5. Basic NAND and NOR Gates

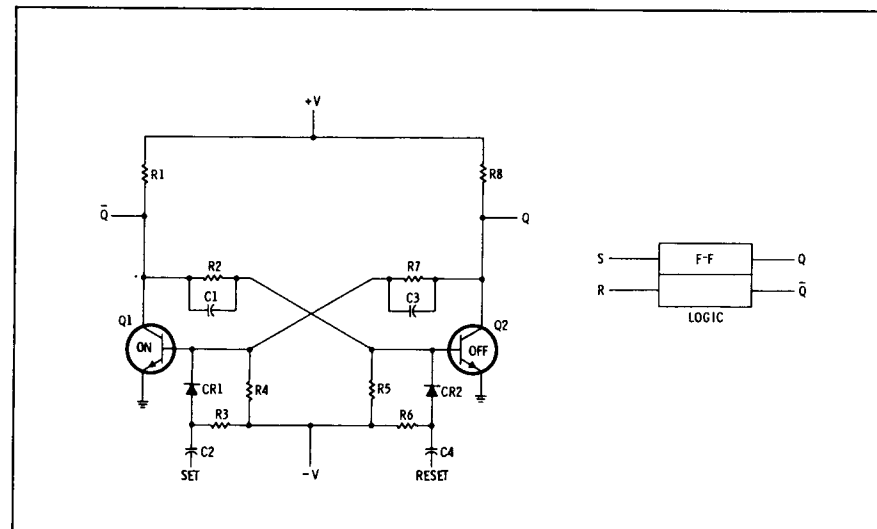


Figure 8-7. RS Flip-Flop

8-53. The RST Flip-Flop

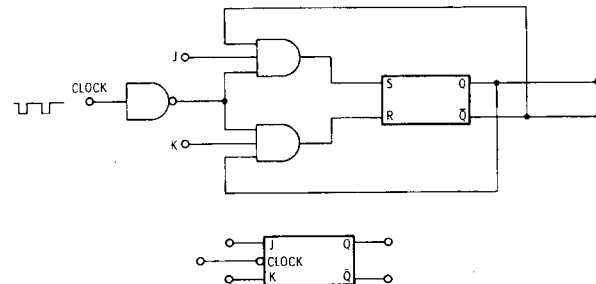
8-54. Figure 8-8 shows an RST flip-flop. It can be set and reset like the RS flip-flop and, in addition, it can be toggled back and forth between its two stable states. A positive pulse (or high) at the S input will set Q high; a high at the R input will set Q low. The circle on the symbol means that the trigger input responds to negative-going triggers. The flip-flop will switch between its two stable states on each input trigger. That is, if Q is high, the next trigger will cause Q to go low.

symbol. Flip-flop response is determined by the values of the J and K inputs at the instant that the trigger pulse arrives at the clock input:

- a. When J and K are low, the flip-flop will remain in whatever state it is in.
- b. When K is high and J is low, the trigger will cause Q to go low (unless it is already low).
- c. When J is high and K is low, the trigger will cause Q to go high (unless it is already high).
- d. When J and K are both high, the flip-flop will toggle between its two stable states. That is, if Q is high, the next trigger will set Q low.

8-55. Clocked JK Flip-Flop

8-56. The clocked JK flip-flop may be assembled from an RS flip-flop, an inverter, and two AND gates. The flip-flop is shown in Figure 8-9 along with its truth table. It has three inputs and two outputs. The clock input is fed by negative (or low) triggers as indicated by the circle on the



J	K	OUTPUT AFTER CLOCK	
		Q	\bar{Q}
0	0	NO CHANGE	
0	1	0	1
1	0	1	0
1	1	TOGGLES	

Figure 8-9. The Clocked JK Flip-Flop

8-57. JK Master/Slave Flip-Flop

8-58. The JK master/slave flip-flop has the same truth table as the JK flip-flop. However, the sequence of operation is not the same. The regular JK flip-flop responds only to the negative portion of the input clock:

b. When the trigger goes low, the information at the J and K inputs is fed into the flip-flop to control its outputs.

a. While the trigger (or clock) pulse is high, the J and K inputs are isolated from the flip-flop.

c. When the trigger again goes high, the J and K inputs are isolated from the flip-flop.

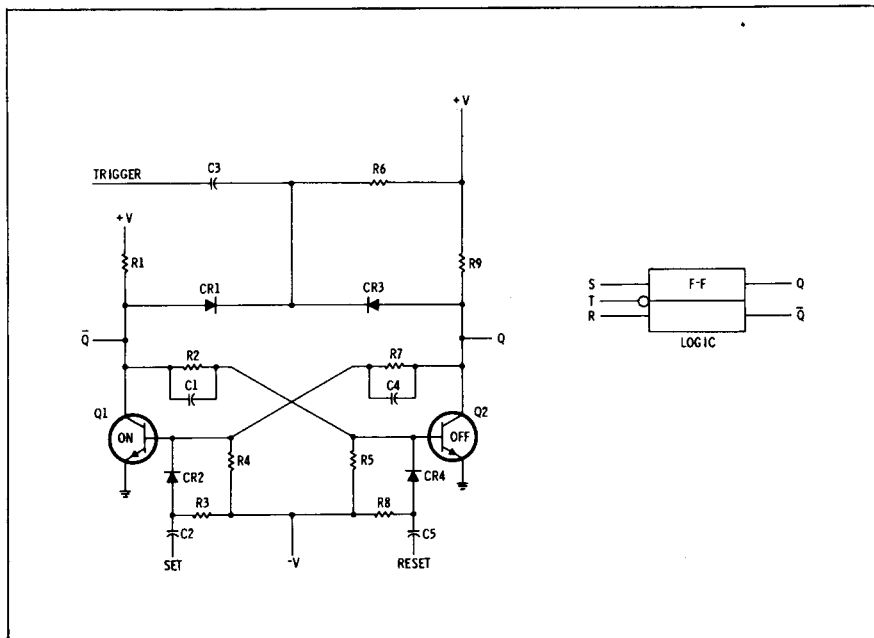


Figure 8-8. RST Flip-Flop

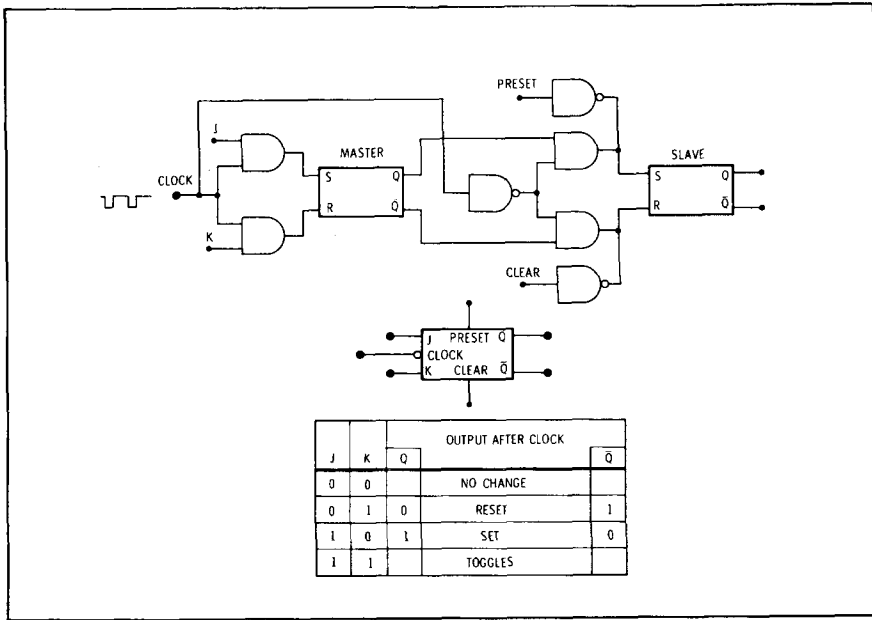


Figure 8-10. JK Master/Slave Flip-Flop

8-59. Figure 8-10 shows one way to assemble a JK master/slave flip-flop. This flip-flop responds to both the positive and the negative portions of the input clock:

a. While the trigger (or clock) pulse is high, the master flip-flop is isolated from the slave flip-flop and J and K information is fed into the master.

b. When the trigger goes low, the J and K inputs to the master are disabled. At the same time the information in the master flip-flop is fed into the slave to control the slave's outputs.

c. When the trigger again goes high, the master is isolated from the slave and J and K information is again fed into the master flip-flop.

8-60. Preset and Clear

8-61. Note in Figure 8-10 that the slave flip-flop has preset and clear inputs connected to it through inverters. Whenever a low is applied to the preset

inverter, the Q output will go high. And whenever a low is applied to the clear inverter, the Q output will go low. These inputs are used in counters and other logic circuits to set flip-flops to a known state, regardless of their other inputs.

8-62. OPERATIONAL AMPLIFIERS

8-63. Circuits and Symbols

8-64. Operational amplifiers are widely used as summing amplifiers, offset amplifiers, buffers and level detectors in regulated power supplies. The particular function is determined by external circuit connections.

8-65. Figure 8-11 shows a typical operational amplifier. Circuit A is a non-inverting buffer amplifier with a gain of 1. Circuit B is a non-inverting amplifier with gain determined by the resistance of R1 and R2. Circuit C is an inverting amplifier with gain determined by R2 and R1. Circuit D shows typical circuit connections and parameters. It is assumed that the amplifier has high gain, low output impedance and high input impedance.

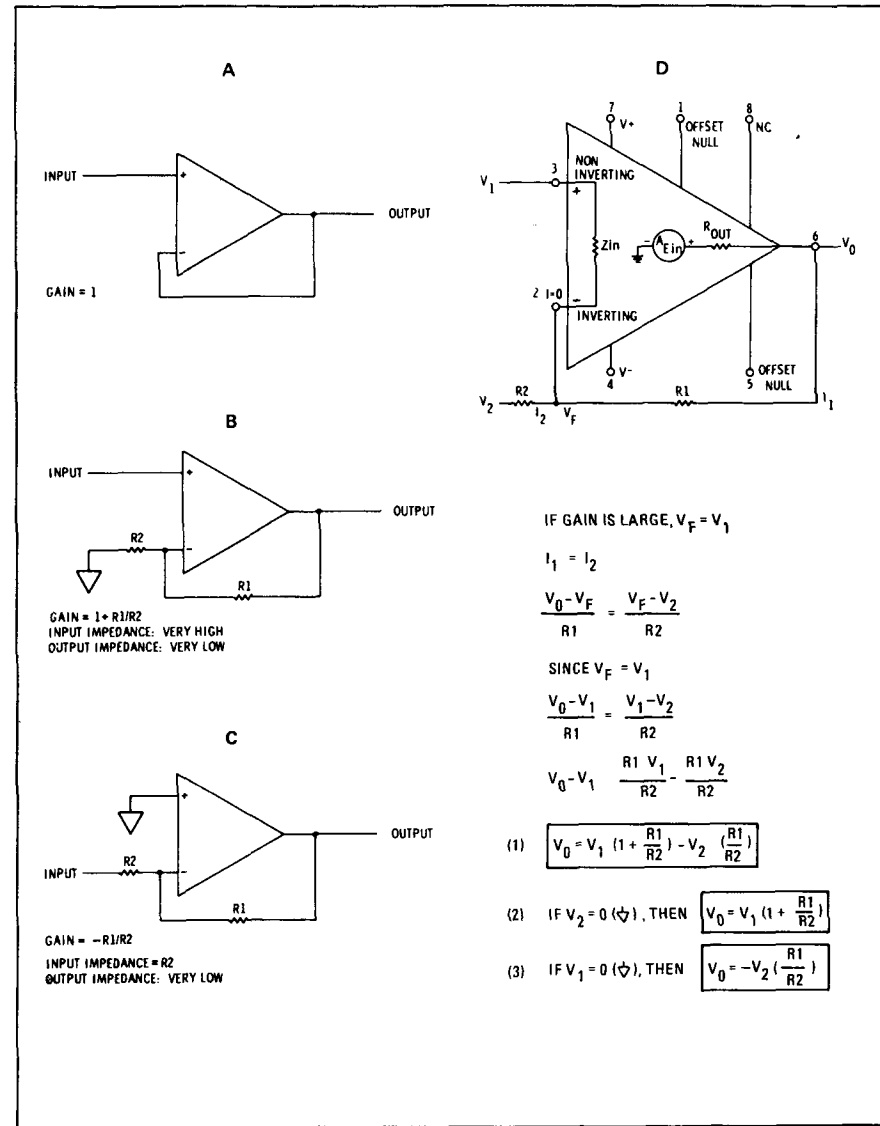


Figure 8-11. Operational Amplifier Equivalent Circuit

8-66. Troubleshooting

8-67. An operational amplifier can be characterized as an ideal voltage amplifier having low output impedance, high input impedance, and very high gain. Also the output voltage is proportional to the difference in the voltages *applied* to the two input terminals. In use, the amplifier drives the input voltage difference close to zero.

8-68. When troubleshooting an operational amplifier, measure the voltages at the two inputs with no signal applied; the difference between these voltages should be less than 10 mV. A difference voltage much greater than 10 mV indicates trouble in the amplifier or its external circuitry. Usually this difference will be several volts and one of the inputs will be very close to an applied circuit operating voltage (for example, +20 V, -12 V).

8-69. Next, check the amplifier's output voltage. It will probably also be close to one of the applied circuit potentials: ground, +20V, -12 V, etc. Check to see that the output conforms to the inputs. For example, if the inverting input is positive, the output should be negative; if the non-inverting input is positive, the output should be positive. If the output conforms to the inputs, check the amplifier's external circuitry. If the amplifier's output does not conform to its inputs, it is probably defective — replace it.

8-70. DIAL CALIBRATION PROCEDURE

8-71. To restring the frequency dial, follow the procedure outlined in Figure 8-12. After the dial is restrung, or after the frequency tuning pot R3 is replaced, perform the following adjustments:

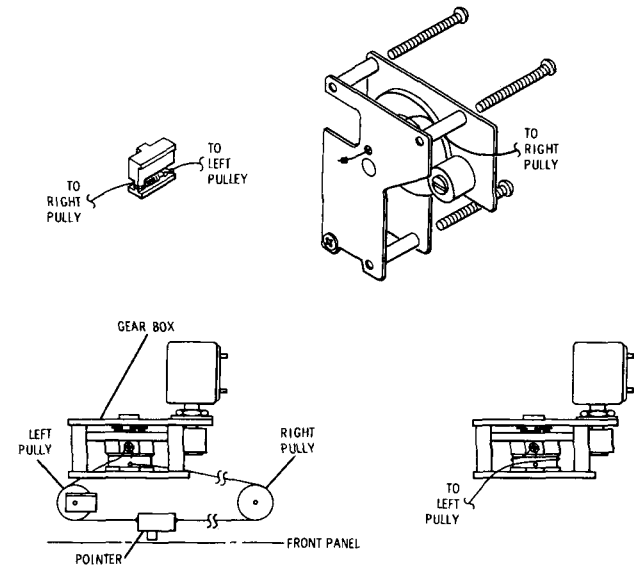
a. Switch RANGE from 0-30 kHz to 0-300 kHz. The final zeros on the CENTER FREQUENCY dial should all be completely visible.

b. Turn FREQUENCY full counter-clockwise. The dial pointer should indicate $\frac{3}{4}$ to $1\frac{1}{4}$ small divisions to the left of 0 kHz.

c. Turn FREQUENCY full clockwise. The dial pointer should indicate at least $\frac{3}{4}$ of a small division to the right of 300 kHz.

d. If necessary, loosen the set screws on the gear shaft of the FREQUENCY pot and re-position the gear slightly by turning the FREQUENCY knob while the pot is at either stop. Then re-tighten the set screws and repeat steps b and c.

e. Perform the frequency calibration adjustments specified in Section V.



1. Remove top cover.
 - a. Tune to low end of scale.
 - b. Remove front panel assembly from side panels.
 - c. Remove scale assembly.
 - d. Remove tuning knobs.
 - e. Remove 2 screws which hold gearbox to panel assembly.
 - f. Remove left pulley at left end of pointer slot.
2. To replace string on right side of pointer:
 - a. Remove pointer from slot, detach old string.
 - b. Access to fixed end of string is through the hole in the front gearbox plate. Line up dial drum with this hole so that old string may be withdrawn.
 - c. Pass a new piece of dial string (about 15 $\frac{1}{2}$ "') through the hole and double knot the fixed end. Clip off excess string and draw the knot into the hole.
 - d. Reset the tuning shaft fully ccw.
 - e. Pass the free end of the string into the right end of the pointer slot. Tie it to the pointer spring where it is attached to the pointer.
 - f. Replace pointer in slot.
3. To replace string on left side of pointer:
 - a. Remove pointer from slot and remove old string.
 - b. Tie approximately 12" of dial string (use double knot) to the pointer spring and replace pointer in slot.
 - c. Replace gearbox screws.
 - d. Turn shaft fully cw.
 - e. Place dial string on pulleys.
 - f. Wrap string around dial drum, and tie under screw-head, while maintaining about 3/16" stretch on pointer spring.
 - g. Reassemble, using reverse of procedure in 1.
4. Check calibration; adjust by moving the 29 tooth gear on the tuning pot shaft. Perform dial calibration procedure.
- g. Replace gearbox screws.
- h. Turn shaft fully cw.
- i. Loosen fixing screw at opposite end of string and adjust string tension so that pointer is stretched 3/16" when string is on pulleys.
- j. Reassemble, using reverse procedure in 1.

















Figure 8-12. Dial Restringing Procedure

Table 8-3. Schematic Diagram Notes

SCHEMATIC DIAGRAM NOTES

Resistance is in ohms, inductance is in microhenries, capacitance is in microfarads unless otherwise noted.
P/O = part of.

*Asterisk denotes a factory-selected value. Value shown is typical. Capacitors may be omitted or resistors jumpered.

	Screwdriver adjustment.		Panel control.
	Encloses front panel designations.		Encloses rear panel designations.
	Circuit assembly borderline.		
	Other assembly borderline.		
	Heavy line with arrows indicates path and direction of main signal.		
	Heavy dashed line with arrows indicates path and direction of main feedback.		
	Wiper moves toward CW with clockwise rotation of control as viewed from shaft or knob.		
	Numbers in stars on circuit assemblies show locations of test points.		
	Encloses wire color code. Code used (MIL-STD-681) is the same as the resistor color code. First number identifies the base color, second number the wider stripe, and the third number identifies the narrower stripe; e.g. 947 denotes white base, yellow wide stripe, violet narrow stripe.		
	Arrow indicates direction of contact movement when relay is energized.		
	Chassis ground.		
	Isolated ground.		
	Indicates non-shorting switch contact.		
	Indicates shorting switch contact.		
VI	Indicates voltage isolated from chassis ground		
VIF	Indicates voltage-isolated-filtered.		

OVERALL TROUBLESHOOTING TREE

INTRODUCTION

The overall troubleshooting tree can be used to quickly isolate trouble to the circuit board, or assembly, level. To implement repair, turn to the indicated service sheet and follow the troubleshooting procedure.

After repairing a circuit board, perform the adjustment procedures, if any, specified in the troubleshooting procedure.

TROUBLESHOOTING

Equipment:

AC Voltmeter	HP 400EL
Oscilloscope	HP 180A/1801A/1820B
X10 Oscilloscope Probe	HP 10004A
Digital Voltmeter	HP 3480B/3484A, Option 042
Cable Assy	HP 1102A
Test Oscillator	HP 651B
BNC Cable Assy (2)	HP 10503A
Adapter	HP 1250-1236
Adapter	HP1250-1237
50 Ohm Feed Thru Termination	HP 11048B
Extender Cable Assy	HP 11592-80015
Interconnection Cable Assy	HP 11592-80016

Extender Cable Installation

Remove the LF Section and IF Section from the Display Section; install the Extender Cable Assembly in the Display Section and connect the appropriate plugs to the LF and IF Sections. Separate the LF and IF Sections and connect the Interconnection Cable Assembly. (See the step-by-step procedure on Service Sheet 1.)

Measurement Procedure

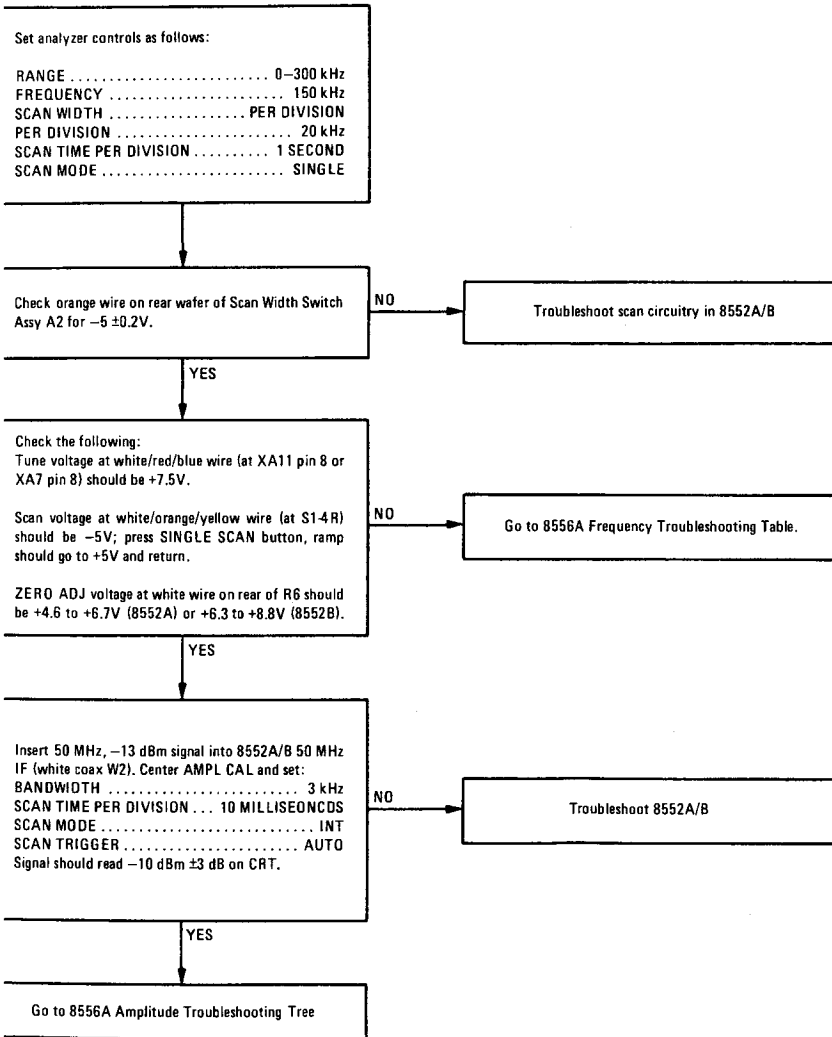
Use the 8552A/B-8556A Trouble Isolation Troubleshooting Tree to isolate trouble to the 8556A. This tree will also branch to the Frequency Troubleshooting Table or to the Amplitude or Tracking Generator Troubleshooting Trees. The latter will branch to a specific Service Sheet.

Set the analyzer controls as specified on the troubleshooting tree, and apply any specified signals using the Test Oscillator, BNC Cable Assembly, and Adapters. Check the dc voltages with the Digital Voltmeter; check the peak-to-peak voltages with the Oscilloscope, and check the rms voltages with the AC Voltmeter. The AC Voltmeter is also used, with the 50 Ohm Feed Thru Termination, to check the power (dBm) readings.

Note

The quickest way to isolate trouble to the 8556A is to substitute a known-good tuning section (such as an 8553B) for the 8556A. If the trouble persists the malfunction is located in the IF Section or the Display Section.

8552A/B – 8556A TROUBLE ISOLATION TROUBLESHOOTING TREE



TRACKING GENERATOR TROUBLESHOOTING TREE
 (no tracking generator output)

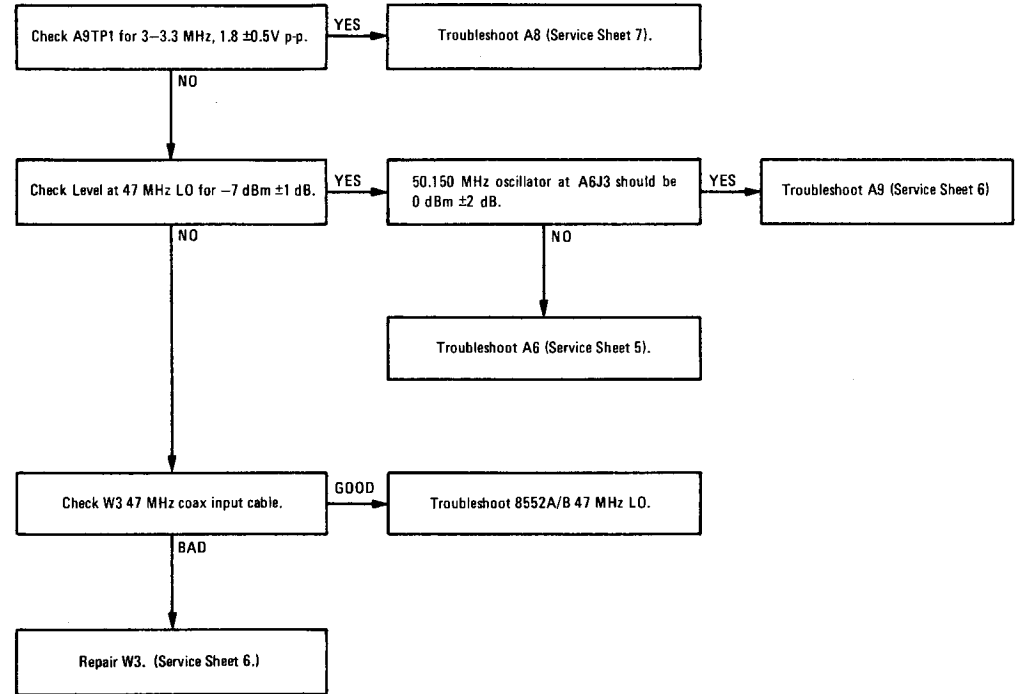
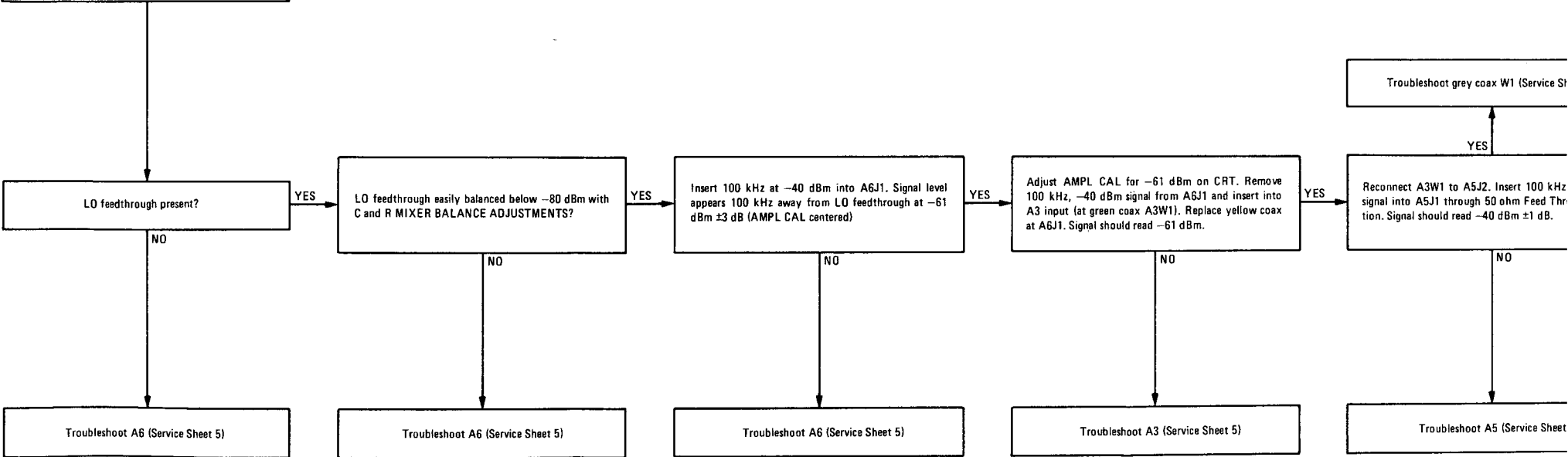


Figure 8-13. Overall Troubleshooting Tree (1 of 2)

AMPLITUDE TROUBLESHOOTING TREE
(display missing or amplitude incorrect)

Connect 50 Ohm Feed Thru to INPUT and set analyzer as follows:

RANGE 0-300 kHz
 FREQUENCY 0 kHz
 BANDWIDTH 1 kHz
 SCAN WIDTH PER DIVISION
 PER DIVISION 20 kHz
 INPUT LEVEL -60 dBm/dBV
 20 kHz MARKERS Out
 dBm/dBV 50Ω dBm
 SCAN TIME PER DIVISION 0.1 SECOND
 LOG/LINEAR 10 dB LOG
 LOG REF LEVEL -40 dBm/dBV
 Vernier c/w
 SCAN MODE INT
 SCAN TRIGGER AUTO
 BASE LINE CLIPPER c/w



FREQUENCY TROUBLESHOOTING TABLE

FAULT	TEST
No Markers	a. Check Tracking Generator output at front panel: 3V rms minimum (TRACKING GEN LEVEL full clockwise).
Inaccurate Frequency Indication	b. Check $\div 150$ circuitry at XA7 Pin 2 or XA6 Pin 8: 20 kHz comb approximately 130 mV p-p. c. Check coupling into mixer at A6C7: 130 mV p-p.
Inaccurate Frequency Indication	a. Check ZERO ADJ voltages at white wire on rear of R6 (ZERO ADJ). Approximate range: +4.6 to +6.7V (8552A) or +6.3 to +8.8 V (8552B). b. Check 300 kHz voltage at white/orange wire on 300 kHz ADJ R5. Approximate range: 14.8 to 16V. c. Check TUNE voltage to IF plug-in at XA7 Pin 8 or XA11 Pin 8: adjustable from 0–15V approximate. d. Check TUNE voltage at white/red/violet wire on back of rear wafer of SCAN WIDTH switch S2 (or XA7 Pin 9): 0 to 15V approximate.
Inaccurate Scan Width	a. Measure scan voltage at white/orange/yellow wire connected to second wafer from rear of SCAN WIDTH switch S1. The level should be about 10V p-p in 20 kHz/DIV and diminish proportionally with decreasing scan width. b. Check 8552A/B Scan Accuracy.
Noisy or Unstable Sweep	a. Check integrated circuits on A7 FREQUENCY control assembly. b. In 8552A/B check frequency control and 47 MHz VTO.

Table 8-4. Assembly and Component Locations

Component	Service Sheet	Photo
A1 Bandwidth Switch	9, 10, 11	Figures 8-40, 43
A2 Scan Width Switch	9, 10	Figures 8-36, 41
A3 Input Level Switch	4, 5, 7, 11	Figures 8-24, 31, 44
A4 (Reserved for Balanced Input)	(3)	
A5 Pre-Attenuator and Preamplifier	4	Figure 8-22
A6 Frequency Converter	5	Figure 8-25
A7 Frequency Control and Marker Generator	8,9	Figures 8-34, 37
A8 Tracking Generator Output	7	Figures 8-29, 30
A9 Tracking Generator Frequency Converter	6	Figure 8-27
A10 Power Supply	12	Figure 8-46
A11 Master Board	4, 5, 6, 7, 8, 9, 12	Figures 8-21, 47
Component	Service Sheet	Photo/Location
C1	4	Figure 8-14
DS1 DISPLAY UNCAL Lamp	12	Figure 6-1
J1 INPUT 1 M Ω	4	Figure 8-14
J2 TRACKING GEN OUT 600 Ω	7	Figure 8-14
P1 Not Assigned		
P2 LF Section/Display Section	12	Figure 8-14
P3 LF Section/IF Section	4, 6, 9, 10, 11, 12	Figure 8-14
R1 TRACK ADJ	7	Figure 8-14
R2 Not Assigned		
R3 FREQUENCY	9	Figure 8-14
R4 FINE TUNE	9	Figure 8-14
R5 300 kHz ADJ	9	Figure 8-14
R6 ZERO ADJ	9	Figure 8-14
R7 AMPL CAL	11	Figure 8-14
S1 dBm/dBV	4	Figure 8-14
S2 20 kHz MARKERS	8	Figure 8-14
S3 RANGE kHz	9	Figure 8-14
W1 Signal Input — Gray	4	Figure 8-14
W2 50 MHz Out — White	5	Figure 8-14
W3 47 MHz LO Input — White	6	Figure 8-14
W4 Tracking Gen Out — Red	7	Figure 8-14
W5 dBm/dBV — Orange	4	Figure 8-14
XA11	4, 7, 8, 9, 12	Figure 8-14

Figure 8-13. Overall Troubleshooting Tree (2 of 2)

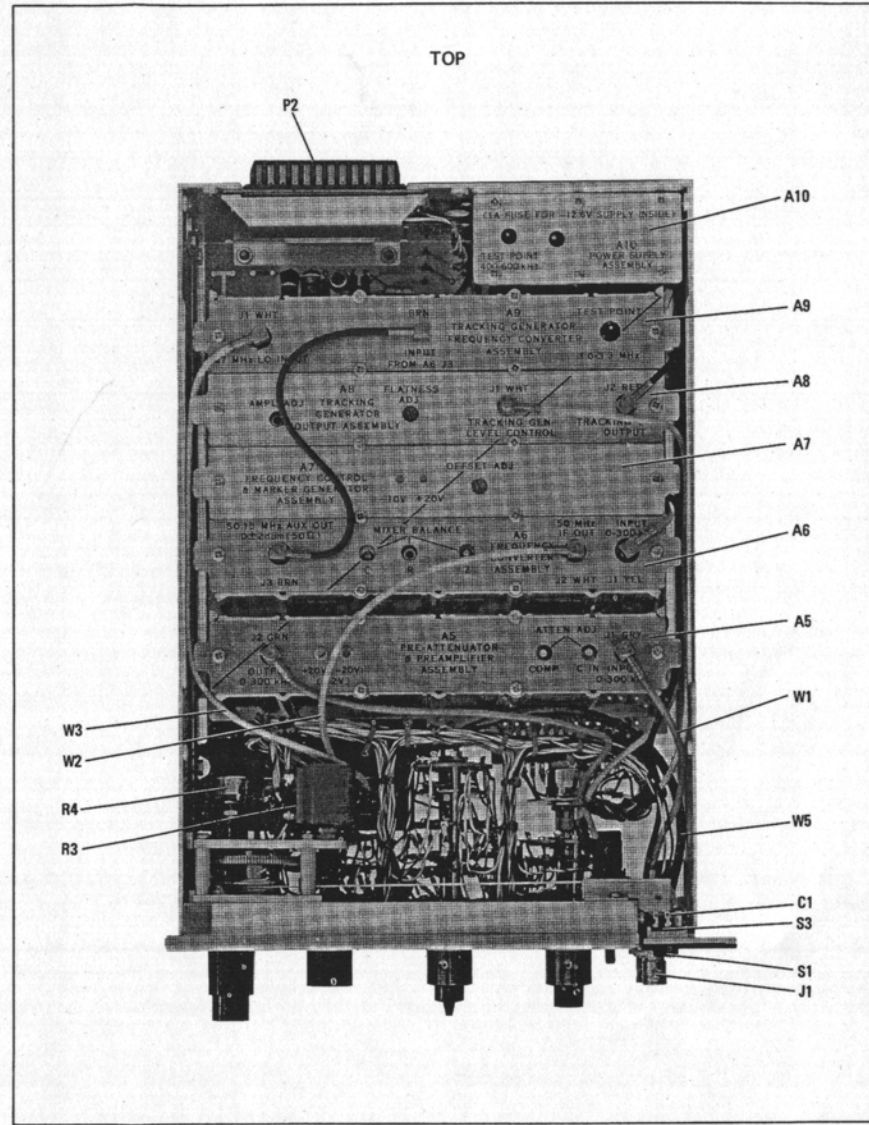
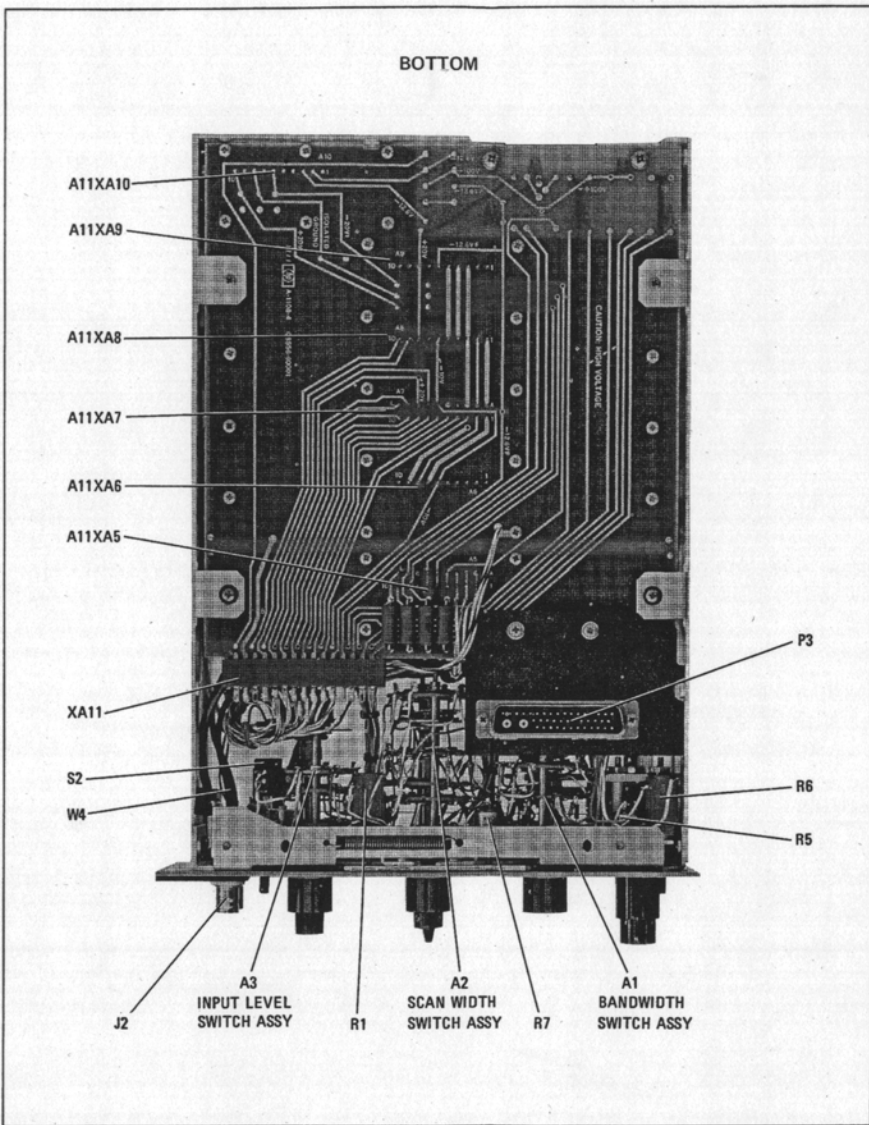


Figure 8-14. Top and Bottom Internal View.

Table 8-5. Connector P2 Pin Identification

Connector P2	Wire Color Code	Function
Pin 1	-	Connects to Pin 4
2	92	+100 Volts
3	-	Open
4	-	Connects to Pin 1
5-7	-	Open
8	0	-12.6 Volts Ground Return
9	-	Open
10	905	To DISPLAY UNCAL Lamp
11	-	Connects to Pin 12
12	-	Connects to Pin 11
13-15	-	Open
16	92	+100 Volts
17-20	-	Open
21	97	-12.6 Volts
22	-	Open
23	-	Connects to Pin 24
24	-	Connects to Pin 23

Table 8-6. Connector P3 Pin Identification

Connector P3	Wire Color Code	Function
Pin 1	912	0.03 kHz (8552B)/0.05 kHz (8552A) Bandwidth
2	913	0.10 kHz Bandwidth
3	914	0.30 kHz Bandwidth
4	915	1.0 kHz Bandwidth
5	926	Frequency Tune Voltage
6	3	±5V Scan Sawtooth
7	5	Linear Gain Compensation
8	6	Linear Gain Compensation
9	938	LOG REF LEVEL Lamp No. 4
10	945	LOG REF LEVEL Lamp No. 5
11	946	LOG REF LEVEL Lamp No. 6 (right)
12	90	Sensing Ground
13	-	Open
14	925	0.01 kHz Bandwidth (8552B Only)
15	904	8552A/B Sensing for ZERO ADJ
16-24	-	Open
25	916	10 kHz Bandwidth
26	902	30 kHz Bandwidth (+20V Out)
27	902	100 kHz Bandwidth (+20V Out)
28	-	300 kHz Bandwidth (Open)
29	96	To AMPL CAL Pot
30	957	Normal Analogic Line
31	934	47 MHz LO Scan Voltage
32	9	ZERO ADJ Voltage
33	935	LOG REF LEVEL Lamp No. 1 (left)
34	936	LOG REF LEVEL Lamp No. 2
35	937	LOG REF LEVEL Lamp No. 3
36	907	-10 Volts
37	902	+20 Volts
38	956	VIDEO FILTER Analogic Line
39	958	ZERO SCAN Analogic Disable Line
40	968	LOG/LINEAR Sensing
41	-	Open
A1	Clear	50 MHz IF
A2	Clear	47 MHz Auxiliary Line

Table 8-7. Connector XA11 Pin Identification

Connector XA11	Wire Color Code	Function
Pin 1	-	Open
2	-	Open
3	1	Pre-Atten Relay Coil Return
4	-	Open
5	907	-10 Volts
6	917	0-200 kHz Scan Tune Offset
7	901	RANGE kHz Switch
8	926	Frequency Tune Voltage
9	923	Scan Width Attenuator Input
10	95	Scan-Offset Amplifier Offset Input
11	91	Tune-Offset Amplifier Frequency Tune Input
12	947	TRACK ADJ Supply
13	-	Open
14	-	Open
15	905	To DISPLAY UNCAL Lamp
A	-	Open
B	-	Open
C	2	Pre-Atten Relay Coil Supply
D	968	LOG/LINEAR Sensing
E	97	-12.6 Volts
F	948	RF Markers Switch
H	928	Tune-Offset Amplifier Output
J	98	FINE TUNE Pot
K	927	Voltage - Follower Amplifier Input
L	93	Scan - Offset Amplifier Scan Input
M	902	+20 Volts
N	967	TRACK ADJ Voltage
P	-	Open
R	0	Chassis Ground
S	-	Open

SERVICE SHEET 1

INTRODUCTION

General

The troubleshooting block diagram can be used to quickly isolate trouble to the circuit board, or assembly, level. To implement repair, turn to the service sheet that covers the faulty circuit board and follow the troubleshooting procedure.

Related Adjustments

After repairing a circuit board, perform the adjustment procedures, if any, specified in the troubleshooting procedure.

TROUBLESHOOTING

Equipment

Oscilloscope HP 180A/1801A/1820B
 X10 Oscilloscope Probe HP 10004A
 Digital Voltmeter . HP 3480B/3484A, Option 042
 Cable Assy HP 11002A
 Test Oscillator HP 651B
 BNC Cable Assy (2) HP 10503A
 Adapter HP 1250-1236
 Adapter HP 1250-1237
 Extender Cable Assy HP 11592-60015
 Interconnection Cable Assy HP 11592-60016

Extender Cable Installation

Push the front panel latch in the direction indicated by the arrow until the latch disengages and pops out from the panel. Pull the plug-ins out of the instrument. Locate the black press-to-release button on the right side of the LF Section. Press the button and firmly pull the two sections apart. When the two sections separate at the front panel, raise the upper section until it is above the lower section by two or three inches at the front panel. Disengage the metal tab-slot connection at the rear and separate the sections. Remove top and bottom covers from the LF Section.

Place the plate end of the HP 11592-60015 Extender Cable Assembly in the Display Section and press firmly into place so that the plugs make contact. The plate and plugs cannot be installed upside down as the plate has two holes corresponding to the two guide rods in the mainframe.

Connect the upper cable plug to the LF Section and the lower cable plug to the IF Section. The plugs are keyed so that they will go on correctly and will not make contact upside down. Connect HP 11592-60016 Interconnection Cable Assembly between the LF and IF Sections. The connectors on the cable are keyed by the shape of the plug and the arrangement of the pins. Press the connectors firmly together and extend the instruments as far apart as the cable will allow without putting stress on the connectors.

Measurement Procedure

Set the analyzer controls as specified on the block diagram. Set the Test Oscillator for the signal shown and apply the signal to INPUT. Apply power to the analyzer.

NOTE

The meter on the HP 651B Test Oscillator is calibrated to read volts into 50 (or 600) ohms. If the oscillator is terminated in a high impedance, such as the analyzer INPUT, its meter will read one-half the applied voltage. Use a 50-ohm Feed Thru termination or set the oscillator for half the desired voltage.

Check the dc voltages shown with a Digital Voltmeter. If the voltages are incorrect, see Service Sheet 12.

Check the waveforms shown with an oscilloscope: use a BNC cable and adapters to check waveforms at cable plugs and jacks, and use the X10 probe to check waveforms at test points and circuit board connector pins (connector pins are available on the bottom of 8556A chassis).

Follow the instructions listed under waveforms. For example, check the signal at A6J3 by removing the brown cable (A9W1) from jack A6J3 and connecting an oscilloscope to the jack with an adapter and a BNC cable.

SERVICE SHEET 2

SIMPLIFIED ANALYZER BLOCK DIAGRAM

The Hewlett-Packard Model 8556A LF Section was designed to be used with an 8552 series IF Section and a 140 series Display Section. When the three units are combined they function as a low frequency spectrum analyzer. The analyzer operates like a swept receiver. It electronically scans an input signal and displays the frequency and amplitude of its composite components on a CRT.

The analyzer's tuning section, the 8556A, contains circuits that amplify the signal and shift its frequency to put it in the IF passband. The LF Section also has a tracking generator and a marker generator.

The IF Section contains a local oscillator that is swept, in frequency, by the same sawtooth that sweeps the CRT. This swept LO is mixed with the signal from the LF Section; the resulting 3 MHz signal passes through bandwidth shaping circuits, a log/linear amplifier, a rectifier, and is sent to the Display Section.

The Display Section has a CRT that displays the signal's amplitude vs. its frequency. Because the amplifiers and oscillators in the analyzer are calibrated, the signal's voltage (mV, μ V, dBV) or power (dBm) and frequency can be read directly on the CRT.

LF SECTION BLOCK DIAGRAM

Pre-Attenuator and Preamplifier

The input signal passes through the pre-attenuator to the preamplifier. The pre-attenuator has 0 or 30 dB of attenuation, depending upon the position of the INPUT LEVEL switch. The preamplifier has a high impedance input and its gain depends upon the way the signal's amplitude is being measured; the gain is set by the IF Section LOG/LINEAR switch and the LF Section dBm/dBV switch.

Post-Attenuator and Frequency Converter

From the preamplifier the signal is fed through the post-attenuator and a low pass filter to a balanced mixer. The post-attenuator works in conjunction with the pre-attenuator. Together they attenuate the input signal from 0 to 50 dB depending upon the setting of the INPUT LEVEL switch. This attenuation reduces spurious mixing products in the mixer, insuring that the mixer is not over-driven.

The low pass filter prevents high frequency signals from reaching the mixer; its cut-off frequency is about 1 MHz. The balanced mixer combines the 20 Hz to 300 kHz input with 50.150 MHz from the crystal oscillator. The difference frequency is fed through the buffer amplifier to the IF Section.

20 kHz Marker Circuits

When the 20 kHz MARKERS switch is depressed, 3 MHz from the tracking generator is fed to the marker dividers. This division results in narrow, 20 kHz pulses which are then fed into the input signal path. The 0.33 microsecond width of the pulse ensures that 20 kHz markers will extend to 300 kHz with no significant amplitude decrease.

SERVICE SHEET 2 (cont'd)

Frequency Control Circuits

The frequency of the 47 MHz LO (located in the IF Section) is determined by:

- The voltage from the voltage follower.
- The voltage from the scan-offset amplifier and scan width attenuator.
- The voltage from the ZERO ADJ pot.

When SCAN WIDTH is set to PER DIVISION or ZERO, the voltage to the voltage follower is determined by the output of the tune-offset amplifier (which sums the voltages from the FREQUENCY and FINE TUNE controls), and by the RANGE switch. In 0-10f, the input to the voltage follower is pre-set.

When SCAN WIDTH is set to PER DIVISION or 0-10f, the ramp from the IF Section is processed by the scan-offset amplifier and attenuated by the scan width attenuator (attenuation is in proportion to the PER DIVISION setting). This ramp then sweeps the 47 MHz LO. The ramp is not used when SCAN WIDTH is set to ZERO.

Tracking Generator Frequency Converter

The tracking generator produces a signal which precisely tracks the spectrum analyzer tuning frequency. The signal from the 47 MHz LO in the IF Section is fed through an amplifier to a balanced mixer. There it is mixed with 50.150 MHz from the frequency converter. The difference frequency (3-3.3 MHz) is filtered, amplified and fed to another balanced mixer.

Tracking Generator Output

The balanced mixer mixes 3 MHz from the crystal oscillator with 3 to 3.3 MHz from the frequency converter. The crystal oscillator can be tuned to center the tracking generator signal in the IF passband. The difference frequency from the balanced mixer is filtered and sent to the output amplifier. The gain of the amplifier is controlled by the TRACKING GEN LEVEL control. The amplifier's output is 100 mV in CAL (into an open circuit) and can be increased to about 3 volts.

Block Diagram

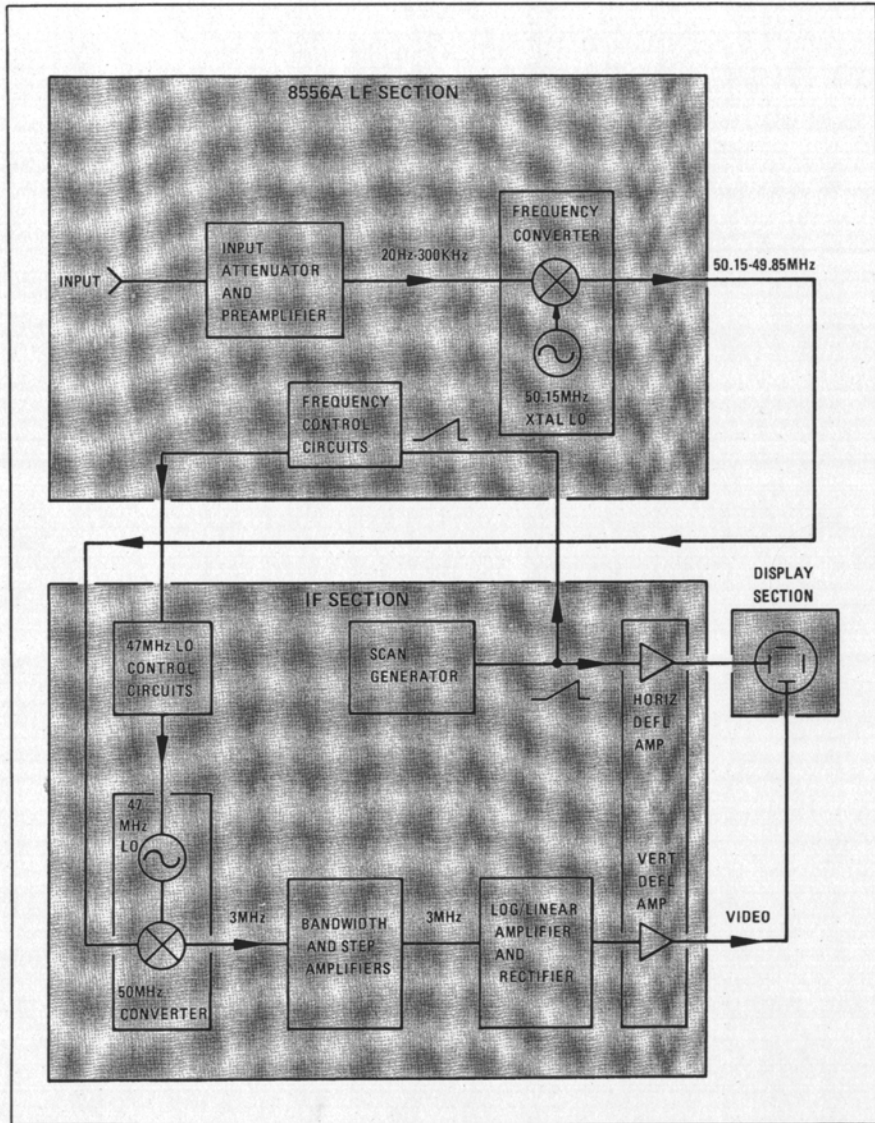
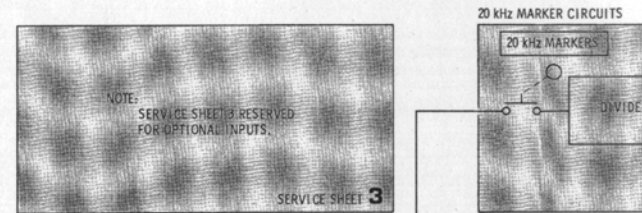
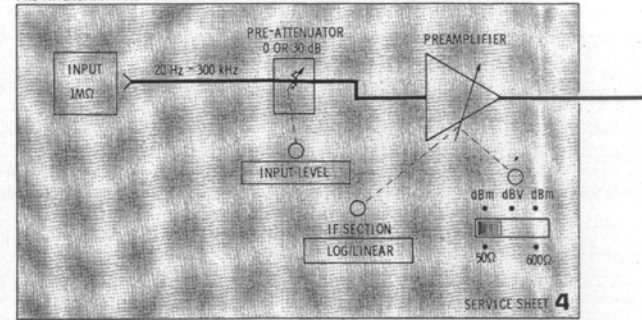
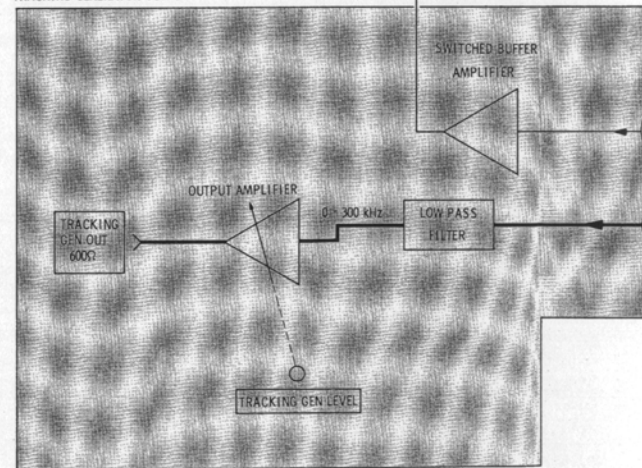


Figure 8-16. Simplified Analyzer Block Diagram

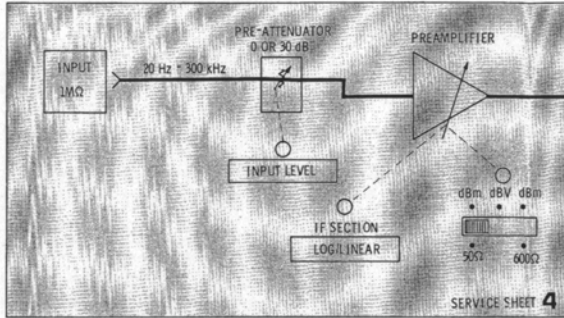
PRE-ATTENUATOR AND PREAMPLIFIER



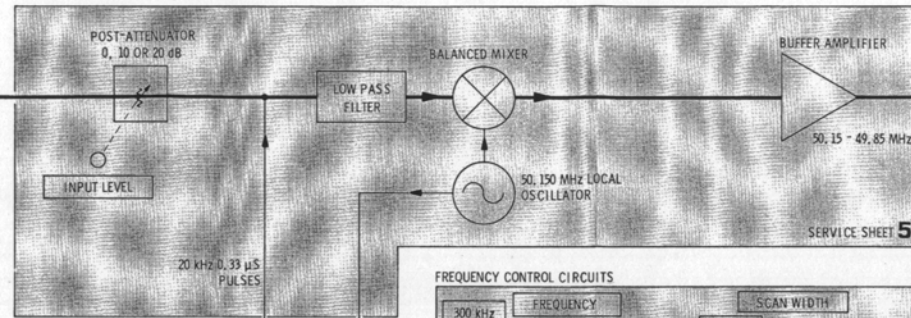
TRACKING GENERATOR OUTPUT



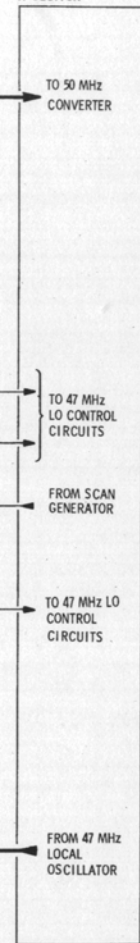
PRE-ATTENUATOR AND PREAMPLIFIER



POST-ATTENUATOR AND FREQUENCY CONVERTER



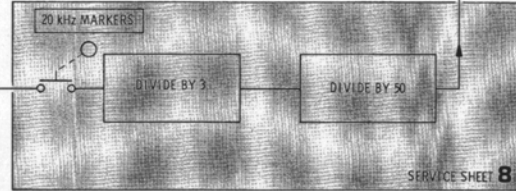
IF SECTION



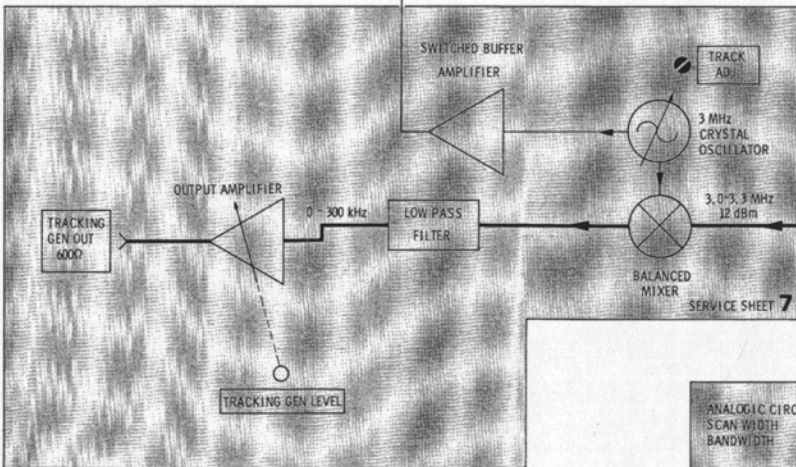
NOTE: SERVICE SHEET 3 RESERVED FOR OPTIONAL INPUTS.

SERVICE SHEET 3

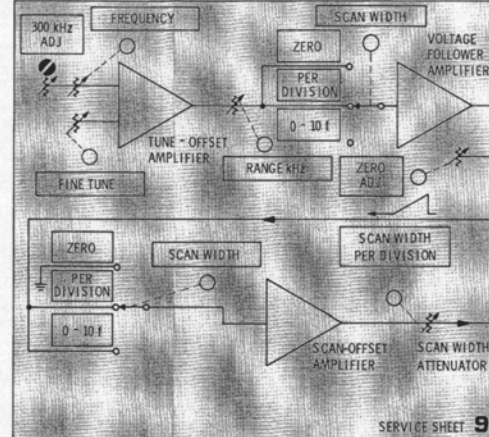
20 kHz MARKER CIRCUITS



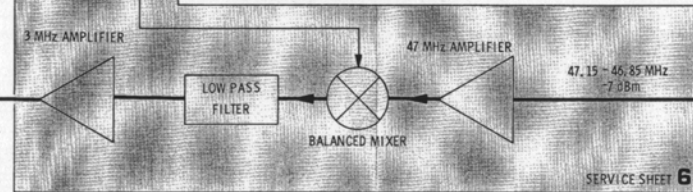
TRACKING GENERATOR OUTPUT



FREQUENCY CONTROL CIRCUITS



TRACKING GENERATOR FREQUENCY CONVERTER



ANALOGIC CIRCUITS: SCAN WIDTH BANDWIDTH

SERVICE SHEET 10

IF SECTION CONTROL CIRCUITS: LOG REF LEVEL LAMPS AMPL CAL BANDWIDTH

SERVICE SHEET 11

VOLTAGE DISTRIBUTION ISOLATED POWER SUPPLY DISPLAY UNCAL LAMP

SERVICE SHEET 12

REFERENCE DESIGNATIONS WITHIN OUTLINED (---) ASSEMBLIES ARE ABBREVIATED. FULL DESIGNATION INCLUDES ASSEMBLY NUMBER: *S, R1 OF ASSEMBLY A1 IS A1B1. DESIGNATIONS OF OTHER COMPONENTS ARE COMPLETE AS SHOWN.

Figure 8-17. LF Section Block Diagram

SERVICE SHEET 4

THEORY OF OPERATION

General

The Pre-Attenuator and Preamplifier Assembly A5 contains the pre-attenuator and the preamplifier, and it is isolated from chassis ground. Preamplifier power is supplied by the Power Supply Assembly A10 (see Service Sheet 12); the isolated ground used by the input circuitry also originates on the A10 assembly.

Pre-Attenuator

The pre-attenuator is used in the last three positions of the INPUT LEVEL switch. The switch controls relay A5K1, and resistors A11R1 and R2 isolate K1 from chassis ground. The pre-attenuator is a 30 dB voltage divider. C IN capacitor A5C6 adjusts attenuator capacitance so that LF Section input capacitance does not change when the attenuator is used. COMP capacitor A5C7 adjusts attenuator flatness. A5R5 and A5CR3 through CR6 protect the preamplifier from input overloads.

Preamplifier

A5Q1 through Q4 and associated circuitry form a feedback amplifier. Q4 is a low noise, junction FET with high input impedance. Q3 is a common base amplifier that matches the low impedance at the drain of Q4 to the high impedance at the base of Q2; this provides high voltage gain. Q2 provides high current gain and some voltage gain. Q1 isolates the collector of Q2 from the A5 assembly's 100 ohm output impedance. The gain of the amplifier is controlled by the feedback from the emitter of Q1 to the source of Q4.

With the LOG/LINEAR switch on the IF Section set to LINEAR, open circuit gain is 8 dB. With LOG/LINEAR set to LOG (either 2 dB or 10 dB), -12.6 V turns on A11Q1, which turns on A5K2. This adds the feedback divider to the amplifier, and the dBm/dBV switch controls amplifier feedback through A5R7, R8 and R9. Therefore, the gain of the amplifier depends upon the settings of the LOG/LINEAR and the dBm/dBV switches.

TROUBLESHOOTING

Equipment:

Digital Voltmeter	HP 3480B/3484A Option 042
Test Oscillator	HP 651B
AC Voltmeter	HP 400EL
BNC Cable Assy (2)	HP 10503A
Cable Assy	HP 11002A
Adapter	HP 1250-1236
Extender Cable Assy	HP 11592-60015
Extender Board	HP 5060-0256

General

Normally trouble is isolated to the Pre-Attenuator and Preamplifier Assembly A5 using the overall troubleshooting tree or the troubleshooting block diagram. Isolate trouble to the circuit level using the troubleshooting tree and procedures outlined below. The voltages listed on the schematic should assist in isolating trouble to a specific component.

SERVICE SHEET 4 (cont'd)

Supply Voltages and Isolation

With Digital Voltmeter measure voltage at +20 VI and -20 VI test points on assembly cover. The voltages should be $+20 \pm 2$ V and -20 ± 2 V. Connect test leads from assembly cover to chassis ground and measure resistance; it should be about 100K ohms.

If either of the above checks are out of limits, remove A5 assembly from chassis and re-check (voltages will be $+28 \pm 4$ V and -28 ± 4 V.) If checks are still out of limits, see Service Sheets 5 and 12.

Pre-Attenuator

Connect AC Voltmeter to A5J2 (OUTPUT) and Test Oscillator to analyzer INPUT (on front panel). Set oscillator for a 3 kHz signal and check that attenuation is 30 dB ± 0.20 dB when INPUT LEVEL is switched from -40 dBm/dBV to -30 dBm/dBV. Set oscillator to 300 kHz and again check attenuation.

If the checks outlined above indicate pre-attenuator malfunction, remove A5 assembly from chassis and re-install on extender board. Check that relay A5K1 is operating correctly, then check components in 30 dB pad. After repairing pre-attenuator, perform adjustments specified in paragraph 5-24.

Preamplifier

Connect Test Oscillator directly to AC Voltmeter; set oscillator for 3 kHz and a -30.00 dB reading on voltmeter (about 25mV). Connect oscillator to analyzer INPUT and connect voltmeter to A5J2 (OUTPUT). Don't change oscillator signal amplitude. Set INPUT LEVEL switch to -40 dBm/dBV and LOG/LINEAR switch to LINEAR. The voltmeter should read -22.00 dB ± 0.20 dB (for a preamplifier open circuit gain of 8 dB).

Set LOG/LINEAR switch to LOG and dBm/dBV switch to dBV. The voltmeter should read -15.00 ± 0.20 dB (for a pre-amplifier open circuit gain of 15 dB).

Set dBm/dBV switch to 600 Ω dBm. The voltmeter should read -12.88 dB ± 0.20 dB (for a preamplifier open circuit gain of 17.22 dB).

Set dBm/dBV switch to 50 Ω dBm. The voltmeter should read -2.00 dB ± 0.20 dB (for a preamplifier open circuit gain of 28 dB). Repeat the checks with oscillator set to 300 kHz.

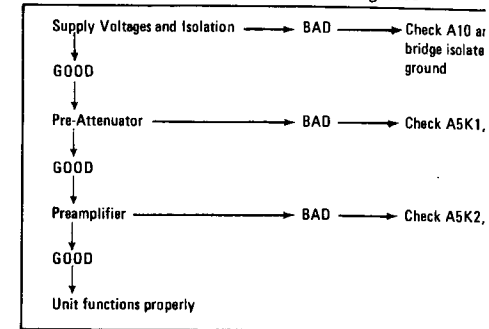
NOTE

If using 8552B IF Section with serial prefix 977 and below, or 8552A with serial prefix 991 and below, check that IF Section connectors XA8 pin 8 and J3 pin 40 are connected together (should be electrical short). If not, connect them with a length of 968 (white-blue-grey) wire (24 AWG).

If the checks outlined above indicate preamplifier malfunction, remove A5 assembly from chassis and re-install on extender board. Check that relay A5K2 is operating correctly; check dBm/dBV switch S1 and A5Q1 through Q4. After repairing preamplifier, perform mixer balance adjustments specified in paragraph 5-26.

SERVICE SHEET 4 (cont'd)

Troubleshooting Tree



SERVICE SHEET 4 (cont'd)

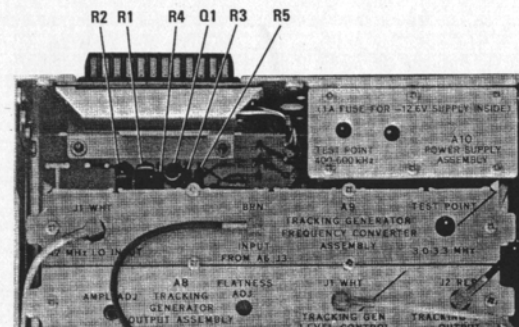
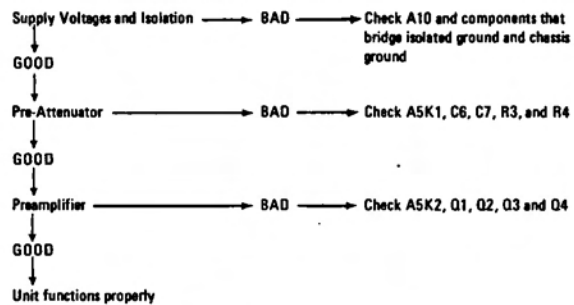
Troubleshooting Tree

Figure 8-21. Master Board Assembly A11 Component Locations

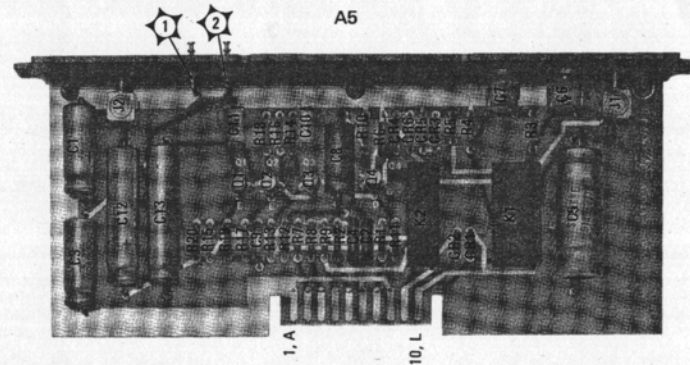
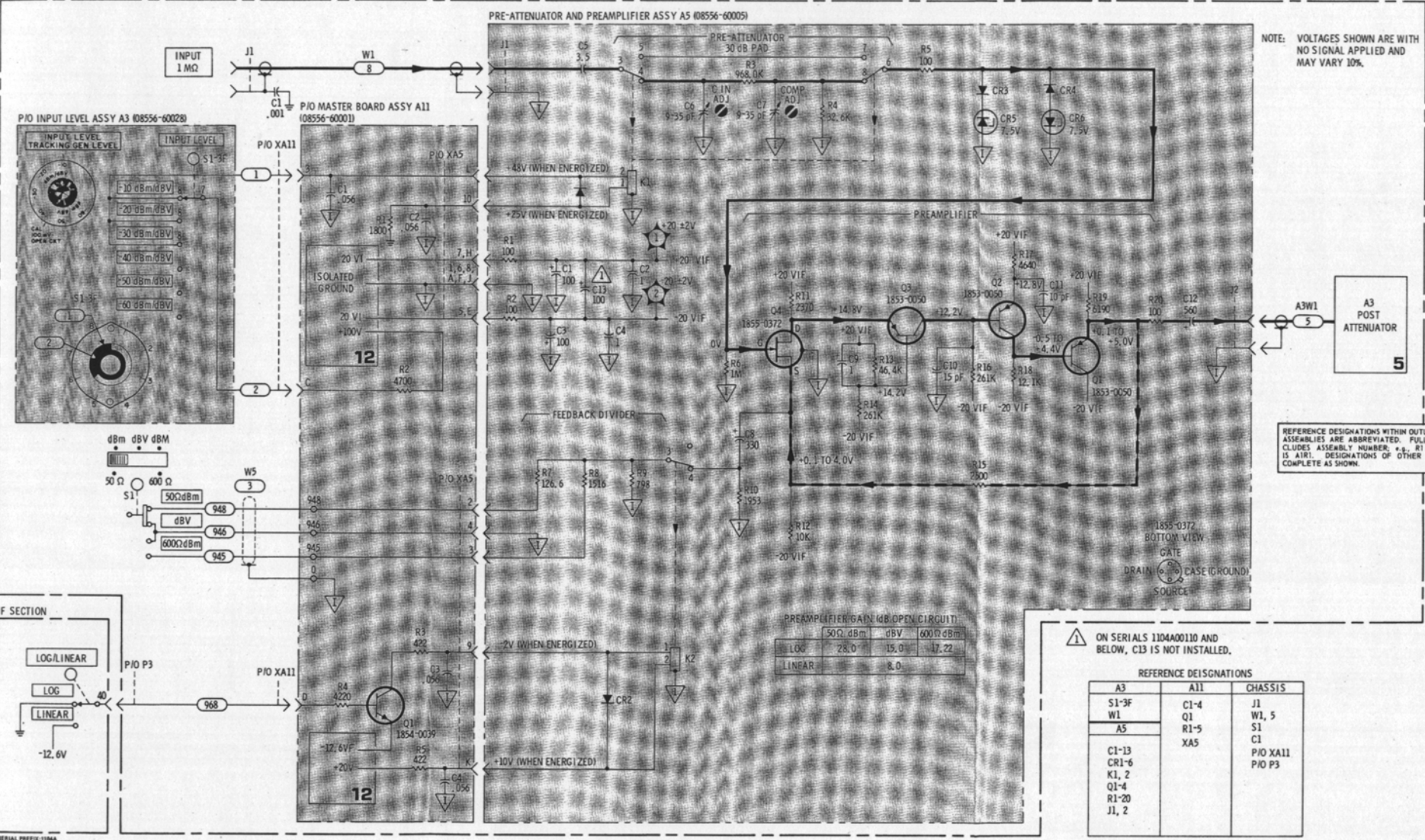


Figure 8-22. Pre-Attenuator and Preamplifier Assy A5 Component Locations

PID LF SECTION 8556A



NOTE: VOLTAGES SHOWN ARE WITH NO SIGNAL APPLIED AND MAY VARY 10%.

REFERENCE DESIGNATIONS WITHIN OUTLINED (---) ASSEMBLIES ARE ABBREVIATED. FULL DESIGNATION INCLUDES ASSEMBLY NUMBER, e.g., R1 OF ASSEMBLY A1 IS AIR1. DESIGNATIONS OF OTHER COMPONENTS ARE COMPLETE AS SHOWN.

PREAMPLIFIER GAIN (dB OPEN CIRCUIT)

	50Ω dBm	dBV	600Ω dBm
LOG	28.0	15.0	-17.22
LINEAR	8.0		

⚠ ON SERIALS 1104A00110 AND BELOW, C13 IS NOT INSTALLED.

REFERENCE DESIGNATIONS

A3	A11	CHASSIS
S1-3F	C1-4	J1
W1	Q1	W1, 5
A5	R1-5	S1
	XAS	C1
		P10 XA11
		P10 P3
C1-13		
CR1-6		
K1, 2		
Q1-4		
R1-20		
J1, 2		

4

Figure 8-23. Pre-Attenuator and Preamplifier: A3, A5 and A11

SERVICE SHEET 5

THEORY OF OPERATION

General

The post attenuator operates in conjunction with the pre-attenuator to control the level of signals reaching the balanced mixer. If INPUT LEVEL is always set to the level of the input signal, distortion in the mixer will be minimum. Isolated ground (see Service Sheets 4 and 12) continues into Input Level Assembly A3 and into Frequency Converter Assembly A6 to the mixer.

Post Attenuator

The post attenuator contains a 20 dB L-pad, a 10 dB L-pad and a straight through connection. They are selected sequentially (0, 10 dB, 20 dB, 0, 10 dB, 20 dB) as INPUT LEVEL is turned counterclockwise. Each L-pad is a simple voltage divider with an impedance of 100 ohms.

Low Pass Filter

The signal from the post attenuator is fed into a low pass filter. Its cut-off frequency is about 1 MHz and its input and output impedance is 100 ohms. The 20 kHz markers, when used, join the signal path at the filter (see Service Sheet 8).

Balanced Mixer

The dual balanced mixer has a matched diode quad and adjustments to null local oscillator feedthrough. The diode quad is composed of four, matched hot carrier diodes and carrier suppression is about 90 dB when properly balanced.

Buffer Amplifier

The buffer amplifier isolates the balanced mixer from the IF Section. The amplifier input has an impedance matching circuit and its gain is about 2 dB.

50.150 MHz Local Oscillator

The 50.150 MHz local oscillator is a crystal controlled Colpitts. Feedback is through the capacitive voltage divider in the tank circuit. The oscillator output is fed through A6Q3 to the mixer; Q3 has a voltage gain of about 2. The output is fed to the tracking generator through A6Q1; Q1 has slightly less than unity gain.

TROUBLESHOOTING

Equipment:

- Oscilloscope HP 180A/1801A/1820B
- X10 Oscilloscope Probe HP 10004A
- Digital Voltmeter HP 3480B/3484A Option 042
- Test Oscillator HP 651B
- AC Voltmeter HP 400 EL
- BNC Cable Assy (2) HP 10503A
- Cable Assy HP 11002A

SERVICE SHEET 5 (cont'd)

- Adapter HP 1250-1236
- Adapter HP 1250-1237
- Extender Cable Assy HP 11592-60015
- Extender Board HP 5060-0256

General

Normally trouble is isolated to the post attenuator and the Frequency Converter Assembly A6 using the overall troubleshooting tree or the troubleshooting block diagram. Isolate trouble to the circuit level using the troubleshooting tree and procedures outlined below. The voltages listed on the schematic should assist in isolating trouble to a specific component.

Extend the LF and IF Sections on the extender cables; remove the A6 assembly from the chassis and re-install it on the extender board.

Isolation

Disconnect yellow cable (A3W2) from A6J1 (INPUT); using Digital Voltmeter, measure resistance from outer conductor of J1 to chassis ground. The voltmeter should indicate an open circuit. If it indicates less than an open circuit, check components in low pass filter and balanced mixer, especially capacitors that bridge isolated ground and chassis ground.

Post Attenuator

Connect Test Oscillator to analyzer INPUT. Connect AC Voltmeter to yellow cable (A3W2) with adapter. Set analyzer INPUT LEVEL to -60 dBm/dBV and adjust oscillator for 0 dBm reference on voltmeter (at about 3 kHz). Check that voltmeter reads as follows while switching INPUT LEVEL:

INPUT LEVEL	Voltmeter
-60 dBm/dBV	0 dB (reference)
-50 dBm/dBV	- 10 dB ±0.2 dB
-40 dBm/dBV	- 20 dB ±0.2 dB
-30 dBm/dBV	- 30 dB (reference)
-20 dBm/dBV	- 40 dB ±0.2 dB
-10 dBm/dBV	- 50 dB ±0.2 dB

If the checks outlined above indicated post attenuator malfunction, check components associated with post attenuator on Input Level Assembly A3.

Low Pass Filter

Connect Test Oscillator to analyzer INPUT; connect Oscilloscope (with X10 probe) to test point A (junction of A6C10, L7, R2 and T3). Set analyzer controls as follows:

- INPUT LEVEL -30 dBm/dBV
- dBm/dBV 50 Ω dBm
- LOG/LINEAR..... LOG

Set oscillator for 3 kHz, 200 mV signal (at the 50 ohm output).

Post Attenuator and Frequency Converter

SERVICE SHEET 5 (cont'd)

NOTE

The meter on the HP 651B Test O read volts into 50 (or 600) ohm terminated in a high impedance, such its meter will read one-half the applied Feed Thru Termination or set the desired voltage.

Check that yellow cable (A3W2) is connected test point A should be 3 kHz sine wave at a level is incorrect check components in low pass filter, perform mixer balance adjustment

50.150 MHz Local Oscillator

Connect Oscilloscope (with X10 probe) to should be 50.150 MHz sine wave, 0.9 V to A6J3 disconnected). Connect probe to test be 50.150 MHz sine wave, 3.2 V to 4.8 V should be 50.150 MHz ±3.0 kHz).

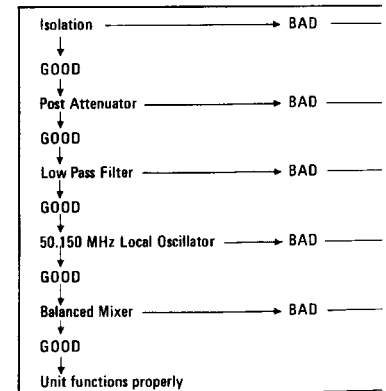
If signal is incorrect at one test point but amplifier. If signal is incorrect at both associated components. After repairing oscil adjustment specified in paragraph 5-25 as specified in paragraph 5-26.

Balanced Mixer

Connect Test Oscillator to analyzer INPUT; probe) to test point D (junction of A6T3, C2

Set analyzer controls and Test Oscillator as Signal at test point D should be 3 kHz mc schematic. Envelope amplitude at test point 0.4 V p-p with clear cable at J2 disconnec incorrect, check components in buffer amp perform mixer balance adjustments specified

Troubleshooting T.



SERVICE SHEET 5 (cont'd)

NOTE

The meter on the HP 651B Test Oscillator is calibrated to read volts into 50 (or 600) ohms. If the oscillator is terminated in a high impedance, such as the analyzer INPUT, its meter will read one-half the applied voltage. Use a 50-ohm Feed Thru Termination or set the oscillator for half the desired voltage.

Check that yellow cable (A3W2) is connected to A6J1 (INPUT). Signal at test point A should be 3 kHz sine wave at approximately 0.2 V p-p. If signal level is incorrect check components in low pass filter. After repairing low pass filter, perform mixer balance adjustments specified in paragraph 5-26.

50.150 MHz Local Oscillator

Connect Oscilloscope (with X10 probe) to test point C (A6Q1-c). Signal should be 50.150 MHz sine wave, 0.9 V to 1.6 V p-p (with brown cable to A6J3 disconnected). Connect probe to test point B (A6Q3-c); signal should be 50.150 MHz sine wave, 3.2 V to 4.8 V p-p. (In both cases, frequency should be 50.150 MHz \pm 3.0 kHz).

If signal is incorrect at one test point but not at both, check appropriate amplifier. If signal is incorrect at both test points, check A6Q2 and associated components. After repairing oscillator, perform 50.150 oscillator adjustment specified in paragraph 5-25 and mixer balance adjustments specified in paragraph 5-26.

Balanced Mixer

Connect Test Oscillator to analyzer INPUT; connect Oscilloscope (with X10 probe) to test point D (junction of A6T3, C22, C23 and L9).

Set analyzer controls and Test Oscillator as specified in low pass filter test. Signal at test point D should be 3 kHz modulation envelope as shown on schematic. Envelope amplitude at test point E (J2) should be approximately 0.4 V p-p with clear cable at J2 disconnected. If envelope amplitude is incorrect, check components in buffer amplifier. After repairing amplifier, perform mixer balance adjustments specified in paragraph 5-26.

Troubleshooting Tree

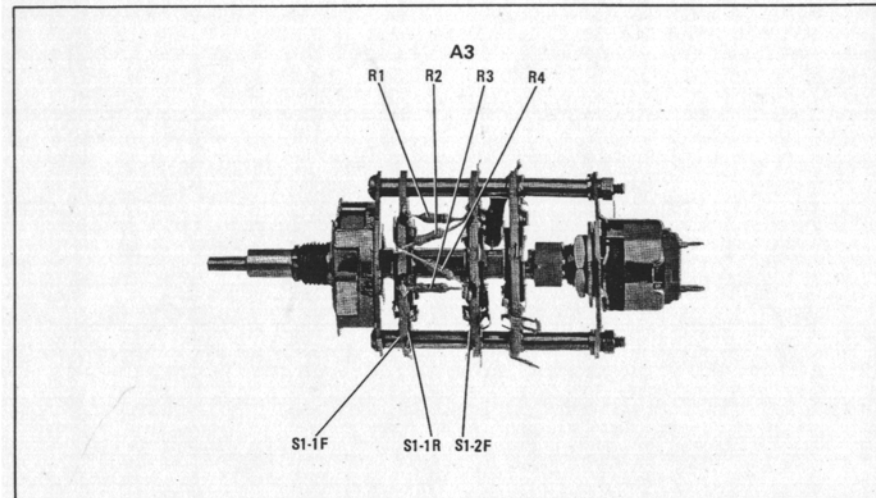
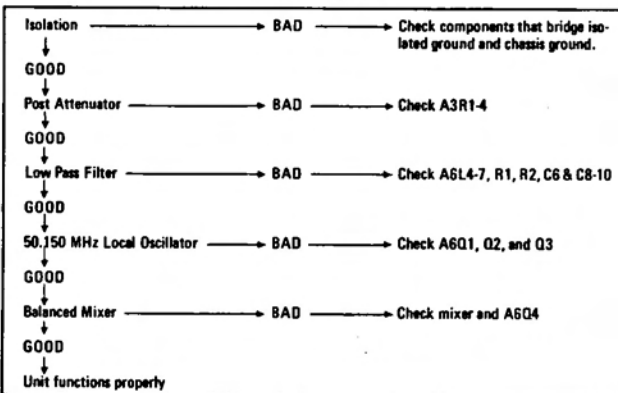


Figure 8-24. Input Level Switch Assembly A3 Component Locations

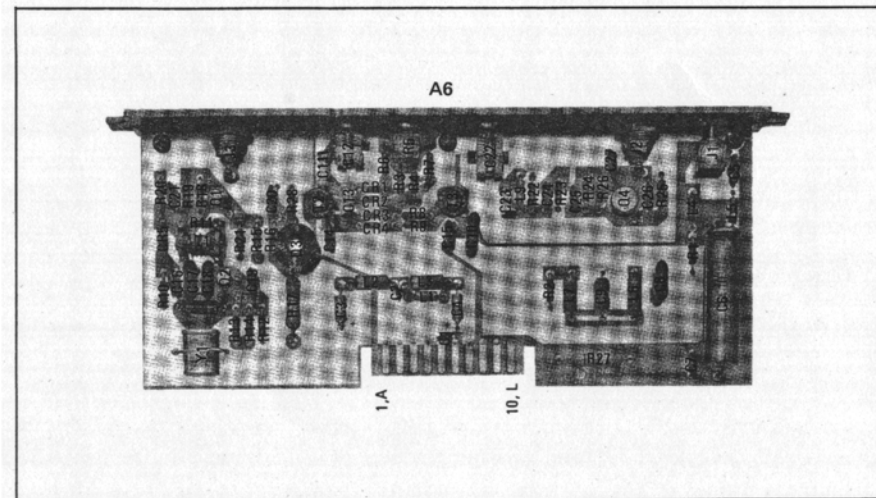


Figure 8-25. Frequency Converter Assy A6 Component Locations

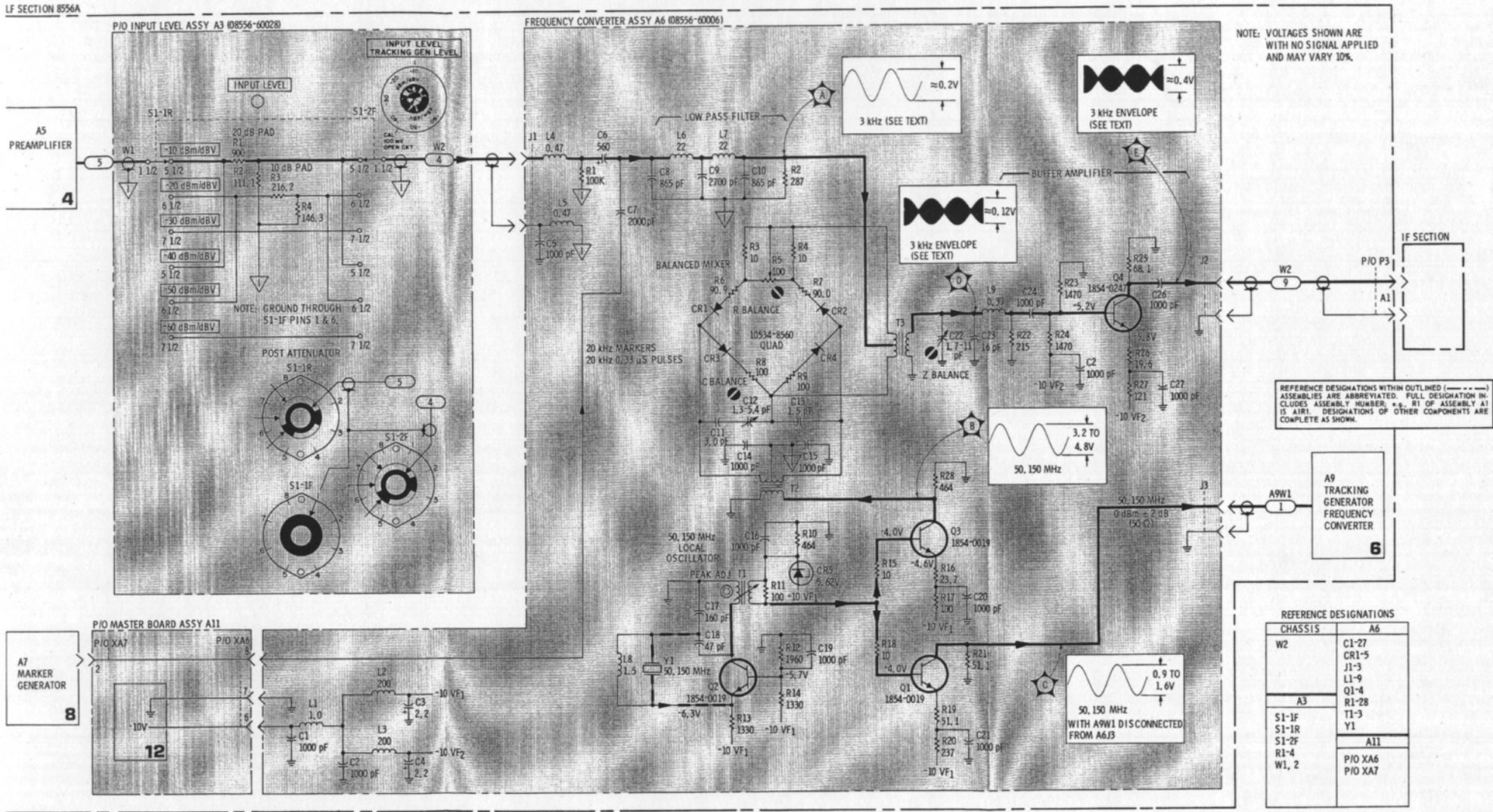


Figure 8-26. Post-Attenuator & Frequency Converter: A3 and A6

SERVICE SHEET 6

THEORY OF OPERATION

General

The tracking generator produces a signal that precisely tracks the spectrum analyzer tuning frequency. It does this by combining the 47 MHz LO from the IF Section with the 50.150 MHz LO from the LF Section, combining the difference frequency (3 to 3.3 MHz) with 3 MHz, and amplifying the second difference frequency (0 to 300 kHz). The circuits associated with the first frequency conversion are on the Tracking Generator Frequency Converter Assembly A9.

47 MHz Amplifier

The signal at A9J1 is 47 MHz \pm 150 kHz and comes from the IF Section 47 MHz LO. Signal amplitude at J1 is about -7 dBm, and is amplified by A9Q1 and Q2; signal amplitude at the mixer is about 1.2 V p-p.

Balanced Mixer

The dual balanced mixer combines 50.150 MHz from the Frequency Converter Assembly A6 with 47 MHz \pm 150 kHz from the amplifier, takes the 3 to 3.3 MHz difference frequency and feeds it to the low pass filter. Filter cut-off frequency is about 5 MHz.

3 MHz Amplifier

A9Q3, Q4 and Q5 form the 3 MHz amplifier, and the 3 to 3.3 MHz signal at the amplifier input is about 120 mV. The amplifier increases this to a level of about 1.2 V p-p which is fed to the balanced mixer in the Tracking Generator Output Assembly A8.

TROUBLESHOOTING

Equipment:

Oscilloscope HP 180A/1801A/1820B
 X10 Oscilloscope Probe HP 10004A
 Digital Voltmeter HP 3480B/3484A Option 042
 Cable Assy HP 11002A
 Extender Cable Assy HP 11592-60015
 Extender Board HP 5060-0256

General

Normally trouble is isolated to the Tracking Generator Frequency Converter Assembly A9 using the overall troubleshooting tree or the troubleshooting block diagram. Isolate trouble to the circuit level using the troubleshooting tree and procedures outlined below. The voltages listed on the schematic should assist in isolating trouble to a specific component.

Extend the LF and IF Sections on the extender cables; remove the A9 assembly from the chassis and re-install it on the extender board.

SERVICE SHEET 6 (cont'd)

47 MHz Amplifier

Connect oscilloscope (with X10 probe) to test point A (A9Q1-b). Set SCAN WIDTH to ZERO; signal should be 46.85 to 47.15 MHz sine wave approximately 0.22 to 0.42 V p-p. If not, check 47 MHz Oscillator in IF Section.

Connect oscilloscope (with X10 probe) to test point B (A9Q2-c). Signal should be 46.85 to 47.15 MHz sine wave at approximately 1.2 V p-p. If not, check 47 MHz amplifier circuits.

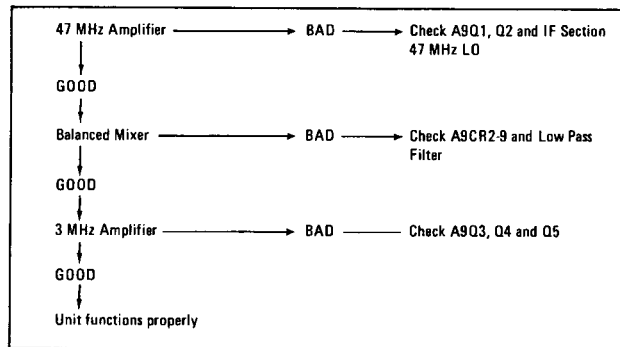
Balanced Mixer

Connect oscilloscope (with X10 probe) to test point C (A6Q3-b). Set SCAN WIDTH to ZERO. Signal should be 3.0 to 3.3 MHz sine wave at approximately 0.35 V p-p. If not, check balanced mixer and low pass filter circuits.

3 MHz Amplifier

Connect Oscilloscope (with X10 probe) to test point 1. Set SCAN WIDTH to ZERO. Signal should be as shown on schematic: 3.0–3.3 MHz, 1.0 \pm 0.3 V p-p. If not, check 3 MHz amplifier circuits.

Troubleshooting Tree



SERVICE SHEET 6 (cont'd)

47 MHz Amplifier

Connect oscilloscope (with X10 probe) to test point A (A9Q1-b). Set SCAN WIDTH to ZERO; signal should be 46.85 to 47.15 MHz sine wave approximately 0.22 to 0.42 V p-p. If not, check 47 MHz Oscillator in IF Section.

Connect oscilloscope (with X10 probe) to test point B (A9Q2-c). Signal should be 46.85 to 47.15 MHz sine wave at approximately 1.2 V p-p. If not, check 47 MHz amplifier circuits.

Balanced Mixer

Connect oscilloscope (with X10 probe) to test point C (A6Q3-b). Set SCAN WIDTH to ZERO. Signal should be 3.0 to 3.3 MHz sine wave at approximately 0.35 V p-p. If not, check balanced mixer and low pass filter circuits.

3 MHz Amplifier

Connect Oscilloscope (with X10 probe) to test point 1. Set SCAN WIDTH to ZERO. Signal should be as shown on schematic: 3.0—3.3 MHz, 1.0 \pm 0.3 V p-p. If not, check 3 MHz amplifier circuits.

Troubleshooting Tree

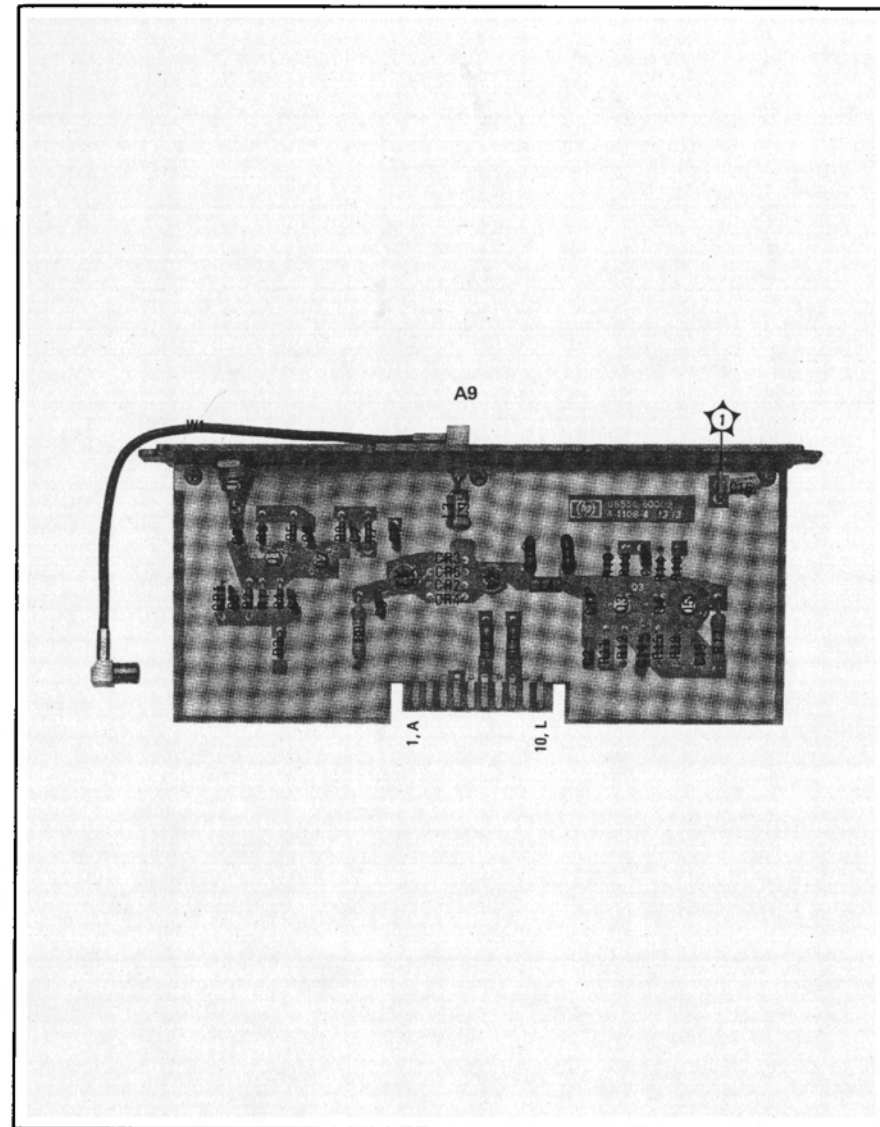
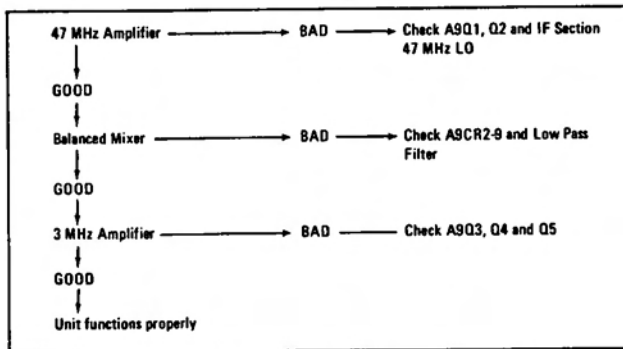


Figure 8-27. Tracking Generator Frequency Converter Assy A9 Component Locations

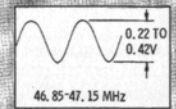
IF SECTION

PIO LF SECTION 8556A

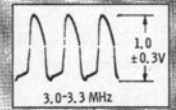
TRACKING GENERATOR FREQUENCY CONVERTER ASSY A9 (8556-60009)

NOTE:
VOLTAGES SHOWN MAY VARY 10%.

47 MHz LO
46.85 - 47.15 MHz
-7 dBm

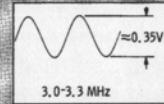
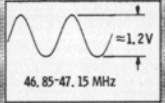


47 MHz AMPLIFIER

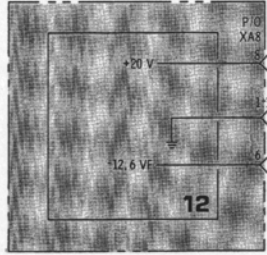


3 MHz AMPLIFIER

A6 FREQUENCY CONVERTER
5



PIO MASTER BOARD ASSY A11



12

PIO MASTER BOARD ASSY A11



A8 TRACKING GENERATOR OUTPUT
7

6

REFERENCE DESIGNATIONS

A9	A11
C1-16	PIO XA8
CR1-5	XA9
J1	CHASSIS
L1-4	
Q1-5	
R1-18	W3
T1-2	PIO P3
W1	

1 ON SERIALS 1104A00110 AND BELOW, C16 IS NOT INSTALLED.

REFERENCE DESIGNATIONS WITHIN OUTLINED (---) ASSEMBLIES ARE ABBREVIATED. FULL DESIGNATION INCLUDES ASSEMBLY NUMBER, e.g., R1 OF ASSEMBLY A1 IS A1R1. DESIGNATIONS OF OTHER COMPONENTS ARE COMPLETE AS SHOWN.

Figure 8-28. Tracking Generator Frequency Converter: A9

SERVICE SHEET 7

THEORY OF OPERATION

General

The tracking generator produces a signal that precisely tracks the spectrum analyzer tuning frequency; 3 to 3.3 MHz from the Tracking Generator Frequency Converter Assembly A9 is mixed with 3 MHz. The difference frequency (0 to 300 kHz) is filtered, amplified, and fed to the front panel.

Balanced Mixer

The balanced mixer combines the 3 to 3.3 MHz signal with 3 MHz from the 3 MHz oscillator and feeds the difference frequency to a low pass filter. The mixer uses a matched diode quad.

3 MHz Oscillator

A8A1Q3 and Q4 form a crystal oscillator. The transistors alternately turn on and off, producing a high amplitude 3 MHz signal.

Varactor A8A1CR7 is used as the fine frequency control element, and the range of varactor control is ± 140 Hz. A8A1L3 is selected to center the range of varactor control at 3 MHz.

A8Q2, CR5 and CR6 limit the 3 MHz signal so that it is flat over the frequency range of the oscillator. The signal level from the balanced mixer depends upon the level of the 3 MHz oscillator signal, so the 3 MHz signal, controlled by AMPL ADJ A8A1R1, is used to amplitude calibrate the tracking generator. Because the mixer's output level is relatively insensitive to changes in signal level from the frequency converter (see Service Sheet 6), tracking generator amplitude calibration is maintained when the LF Section is used with different IF Sections.

Switched Buffer Amplifier

Buffer amplifier A8A1Q1 is normally off. It is activated by negative voltage from the marker generator circuits whenever the 20 kHz MARKERS switch is depressed (see Service Sheet 8). When the amplifier is on it feeds 3 MHz to the marker generator.

Low Pass Filter

A8Q1 is a buffer amplifier that isolates the filter from the mixer. A8Q2 isolates the filter from the output amplifier. FLATNESS ADJ A8R9 in the emitter of Q1 adjusts the flatness of the high end of the filter by varying the filter's input resistance. The filter is flat to 300 kHz.

Output Amplifier

A8Q3 through Q6 form a feedback amplifier. A6 provides enough current so that at maximum signal with the output shorted the amplifier does not clip. Amplifier gain is controlled by TRACKING GEN LEVEL control A3R5; gain is variable from 3 to 100 (10 to 40 dB). When TRACKING GEN LEVEL is full counter-clockwise (CAL 100 mV), the amplifier has a gain of 3 and delivers 100 mV into an open circuit (50 mV into 600 ohms). As TRACKING GEN LEVEL is turned clockwise, A8R12, R13C8, and A3R5 divide the feedback and amplifier gain increases.

SERVICE SHEET 7 (cont'd)

TROUBLESHOOTING

Equipment:

Digital Voltmeter	HP 3480B/3484A Option 042
AC Voltmeter	HP 400EL
BNC Cable Assy	HP 10503A
Cable Assy	HP 11002A
Oscilloscope	HP 180A/1801A/1820B
X10 Oscilloscope Probe	HP 10004A
Extender Cable Assy	HP 11592-60015
Extender Board	HP 5060-0256
Frequency Counter	HP 5327C

General

Normally trouble is isolated to the Tracking Generator Output Assembly A8 using the overall troubleshooting tree or the troubleshooting block diagram. Isolate trouble to the circuit level using the troubleshooting tree and procedures outlined below. The voltages listed on the schematic should assist in isolating trouble to a specific component.

Extend the LF and IF Sections on the extender cables; remove the A8 assembly from the chassis and re-install it on the extender board.

3 MHz Oscillator

Depress 20 kHz MARKERS switch and connect Oscilloscope (with X10 probe) to test point C (A11XA8 pin 2); signal should be as shown on schematic: about 3 MHz, 4 V p-p. Connect Frequency Counter to test point C and vary TRACK ADJ, on analyzer front panel, through its full range. Frequency should vary (from 3 MHz) at least ± 140 Hz. (Factory selected component A8A1L3 sets center of variation, see Table 8-1.)

If checks indicate oscillator malfunction, remove cover from 3 MHz Oscillator Assembly A8A1 and check A8A1Q1, Q3, Q4 and associated components. After repairing oscillator, perform tracking generator adjustments specified in paragraph 5-27.

NOTE

A8A1 can usually be repaired without unsoldering entire board. If it becomes necessary to unsolder A8A1, unsolder the six pins with a recommended desoldering tool (see General Service Hints). Excess heat or force on pins will pull plating off board.

Balanced Mixer

Connect Oscilloscope (with X10 probe) to test point D (A8Q1-b); signal should be modulation envelope as shown on schematic: about 3 MHz, 0.12 V p-p. If not, remove cover from 3 MHz Oscillator Assembly A8 and check balanced mixer, A8A1Q1 and associated components. After repairing mixer, perform tracking generator adjustments specified in paragraph 5-27.

SERVICE SHEET 7 (cont'd)

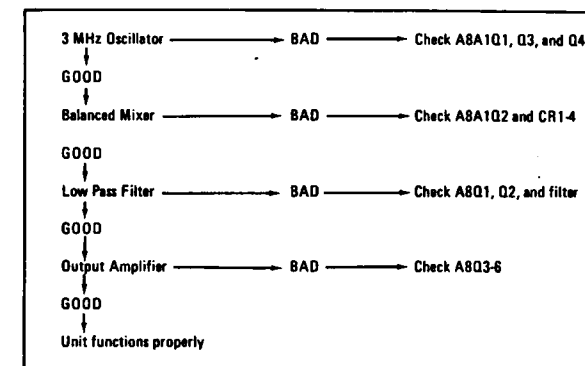
Low Pass Filter

Connect Oscilloscope (with X10 probe) to test point E (A8Q2-e); should be 20 Hz to 300 kHz sine wave, approximately 0.1 V p-p. I check Q8Q1, Q2 and associated components. After repairing filter, perform tracking generator adjustments specified in paragraph 5-27.

Output Amplifier

Set TRACKING GEN LEVEL to CAL 100 mV and connect oscilloscope test point F (A8Q6-e); signal should be 20 Hz to 300 kHz sine wave, 0 p-p. If not, check A8Q3 through Q6 and associated components, repairing amplifier, perform tracking generator adjustments specified in paragraph 5-27.

Troubleshooting Tree



SERVICE SHEET 7 (cont'd)

Low Pass Filter

Connect Oscilloscope (with X10 probe) to test point E (A8Q2-e); signal should be 20 Hz to 300 kHz sine wave, approximately 0.1 V p-p. If not, check Q8Q1, Q2 and associated components. After repairing filter, perform tracking generator adjustments specified in paragraph 5-27.

Output Amplifier

Set TRACKING GEN LEVEL to CAL 100 mV and connect oscilloscope to test point F (A8Q6-e); signal should be 20 Hz to 300 kHz sine wave, 0.28 V p-p. If not, check A8Q3 through Q6 and associated components. After repairing amplifier, perform tracking generator adjustments specified in paragraph 5-27.

Troubleshooting Tree

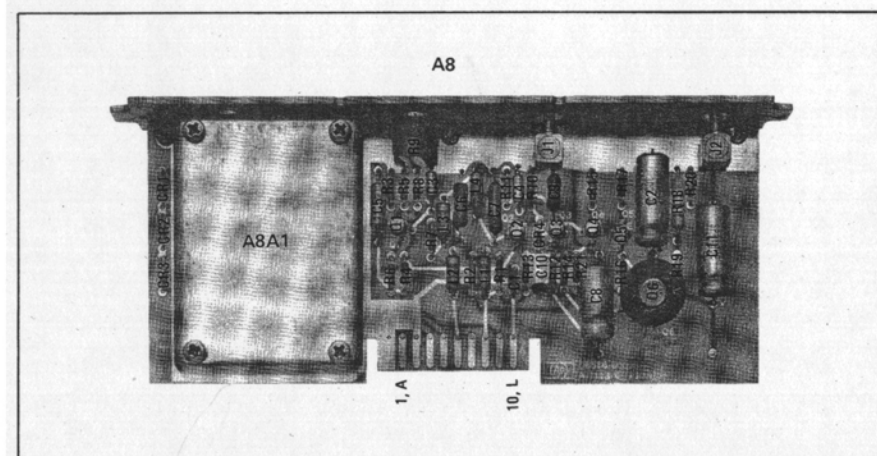
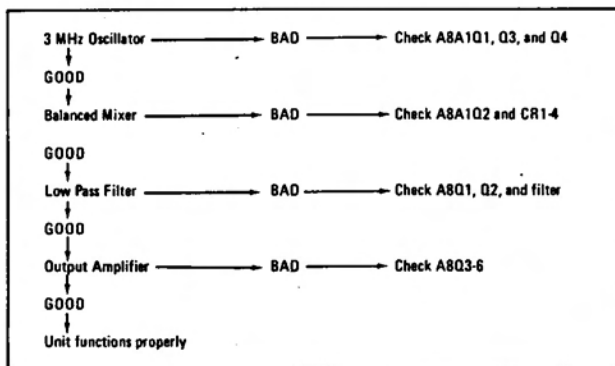


Figure 8-29. Tracking Generator Output Assy A8 Component Locations

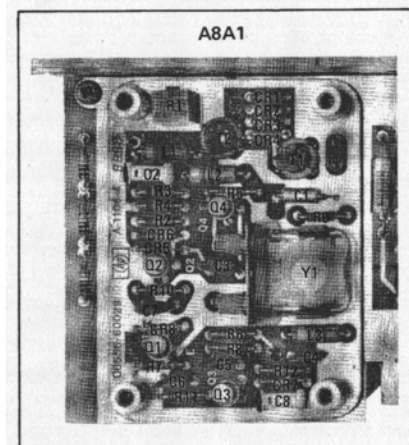


Figure 8-30. 3 MHz Oscillator Assy A8A1 Component Locations

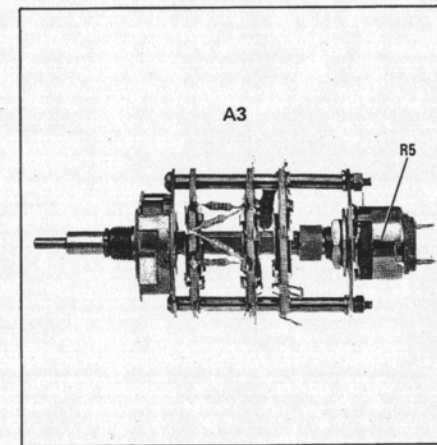
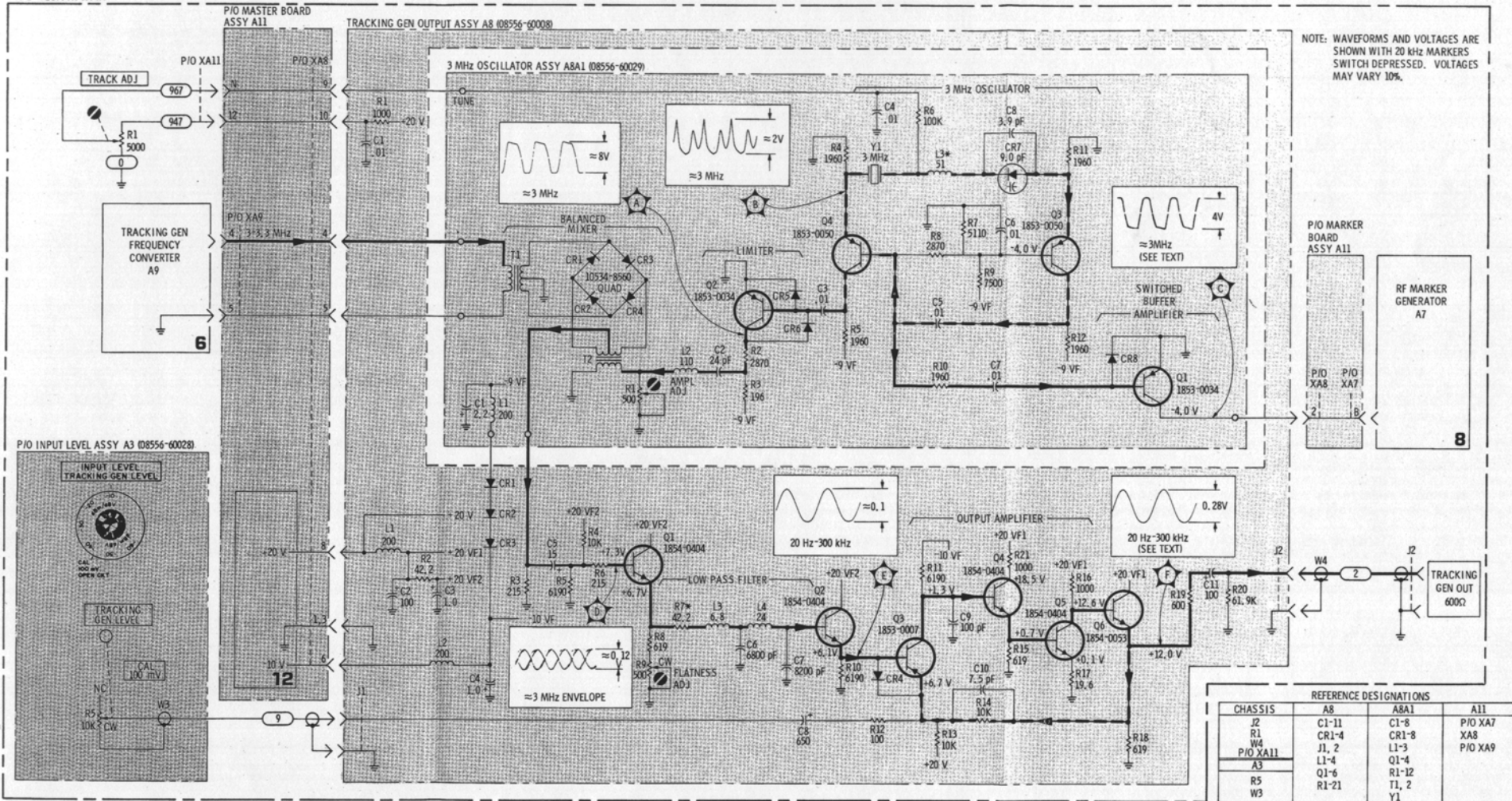


Figure 8-31. Input Level Switch Assy Component Locations

PIO LF SECTION 8556A



REFERENCE DESIGNATIONS			
CHASSIS	A8	A8A1	A11
J2	C1-11	C1-8	P/O XA7
R1	CR1-4	CR1-8	XA8
W4	J1, 2	L1-3	P/O XA9
PIO XA11	L1-4	Q1-4	
A3	Q1-6	R1-12	
R5	R1-21	T1, 2	
W3		Y1	

REFERENCE DESIGNATIONS WITHIN OUTLINED (---) ASSEMBLIES ARE ABBREVIATED. FULL DESIGNATION INCLUDES ASSEMBLY NUMBER. *E, R1 OF ASSEMBLY A1 IS A1R1. DESIGNATIONS OF OTHER COMPONENTS ARE COMPLETE AS SHOWN.

7

Figure 8-32. Tracking Generator Output: A3 and A8

SERVICE SHEET 8

THEORY OF OPERATION

General

The 20 kHz marker circuits apply markers to the input signal path when the 20 kHz MARKERS switch is depressed. A7Q1 turns on and applies -5 V to A7U1, U2, U3, U6 and U7. It also applies negative voltage through A7R1 to Q1 on the 3 MHz Oscillator Assembly A8A1 (see Service Sheet 7). A8A1Q1 amplifies 3 MHz and feeds it to the 20 kHz marker circuits. The input 3 MHz sine wave is clipped by A7U7C and fed to the divide by 3 circuits.

Divide by 3 Circuits

A7U6 is dual JK master/slave flip-flop, and U6A and U6B form a Johnson, or shift, counter. The counter has four possible states: binary 0, 1, 2 and 3. In normal operation the counter cycles through binary counts 1, 2 and 3, changing from one to the other on the negative half cycle of each input pulse. If the counter ever cycled into binary 0 (both Q outputs low) it would not cycle itself out. U7B, connected to the Q outputs, clears flip-flop U6B if, and only if, the counter cycles into binary 0. The counter's output is decoded by NAND gate U7A, inverted by U7D, and fed to the divide by 50 circuit. The output at U7D is a 1 MHz pulse, 0.33 μ s wide.

Divide by 50 Circuit

A7U1, U2 and U3 form series, or ripple, counter circuits that divide the 1 MHz pulse by 50 without changing its 0.33 μ s pulse width. U1 divides the pulse by 10 and feeds it to U2 and to quad-input NAND gate U3. U2 divides the pulse by 2 and divides the input from U1 by 5 and sends both outputs to U3. When all four inputs of U3 are high, its output goes low. As shown in the timing diagram, this results in a 20 kHz pulse with a very narrow pulse width (0.33 μ s). The narrow pulse width insures that the 20 kHz markers will extend beyond 300 kHz without significant amplitude decreases.

TROUBLESHOOTING

Equipment:

Oscilloscope	HP 180A/1801A/1820B
X10 Oscilloscope Probe (2)	HP 10004A
Digital Voltmeter	HP 3480B/3484A Option 043
Cable Assy	HP 11002A
Extender Cable Assy	HP 11592-60015
Extender Board	HP 5060-0256

General

Normally trouble is isolated at the Frequency Control and Marker Generator Assembly A7 using the overall troubleshooting tree or the troubleshooting block diagram. Isolate trouble to the circuit level using the troubleshooting tree and procedures outlined below. The voltages listed on the schematics should assist in isolating trouble to a specific component.

Extend the LF and IF Sections on the extender cables; remove the A7 assembly from the chassis and re-install it on the extender board.

SERVICE SHEET 8 (cont'd)

Switched Power Supply

Push 20 kHz MARKERS switch and check voltages shown on schematic with a Digital Voltmeter. If voltages are incorrect, check A7Q1 and associated circuitry.

Divide By 3 Shift Counter

Push 20 kHz MARKERS switch and connect Oscilloscope (with X10 probes) to test points 1 and 2. Check pulse amplitudes and widths as shown on schematic. Check that pulse relationships approximate those shown in shift counter timing diagram. If checks indicate shift counter malfunction, check A7U6, U7 and associated circuitry.

Divide By 50 Counter

Push 20 kHz MARKERS switch and connect Oscilloscope (with X10 probes) to test points 2 and 3. Check pulse amplitudes and widths as shown on schematic. Check that pulse relationships approximate those shown in counter timing diagram. If checks indicate shift counter malfunction, check A7U1, U2, U3 and associated circuitry.

Troubleshooting Tree

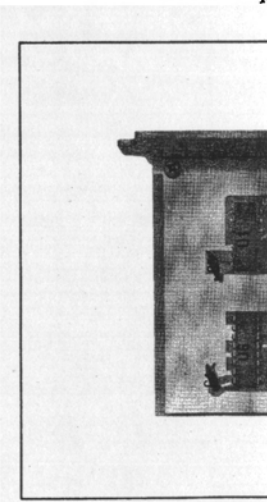
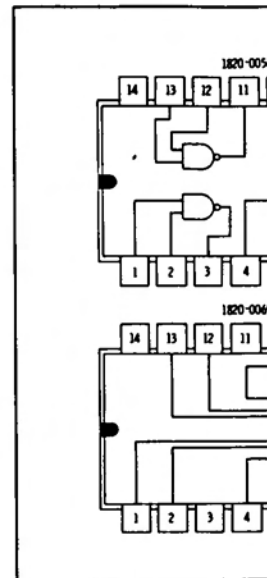
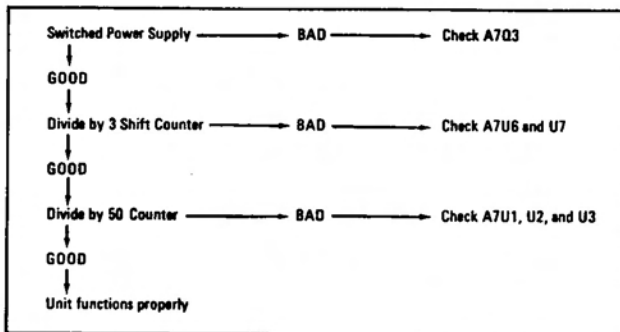
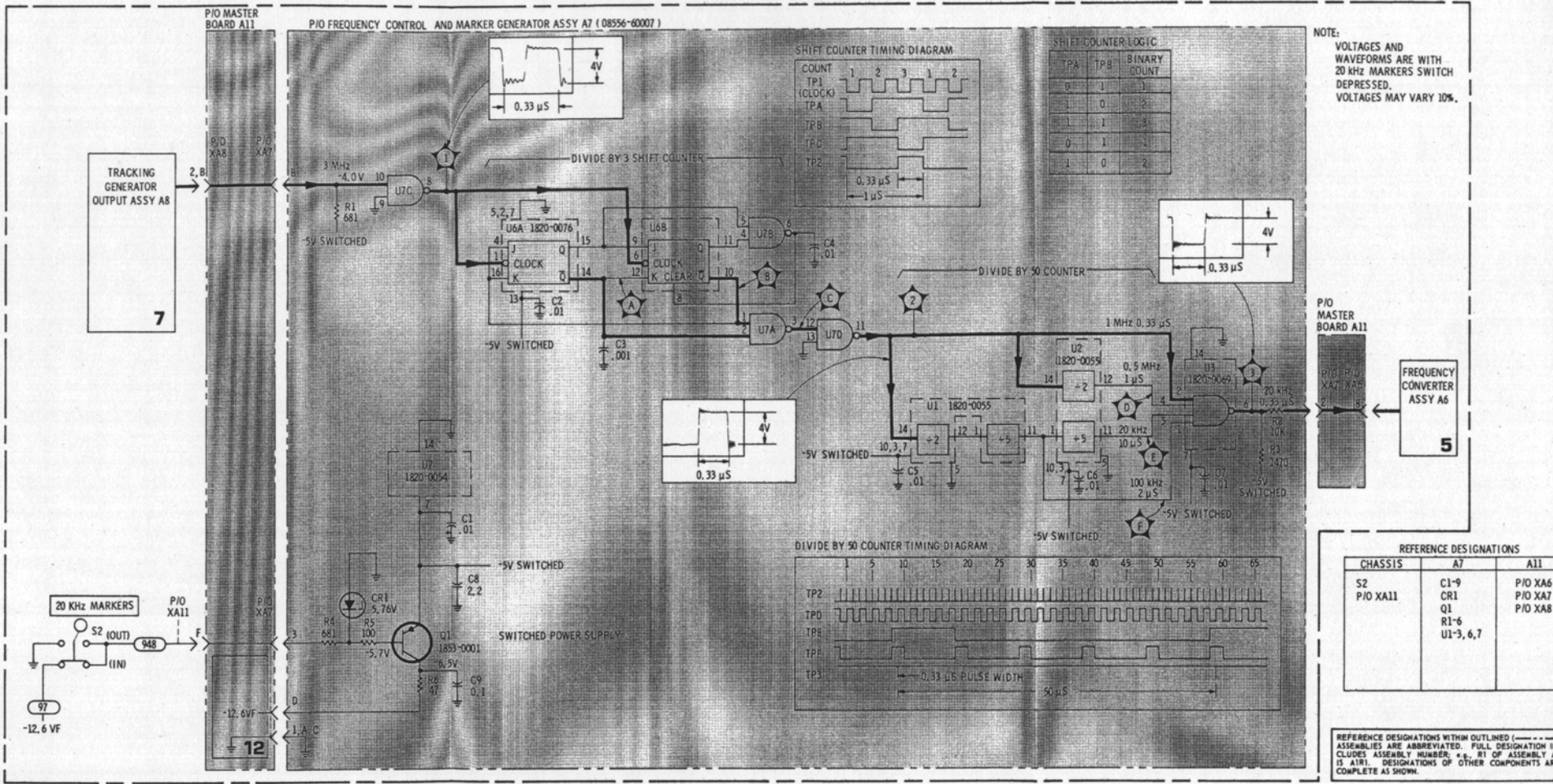


Figure 8-



SERIAL PREFIX: 1104A

Figure 8-35. 20 KHz Marker Cir

THEORY OF OPERATION

General

The frequency control circuits provide control voltages to the 47 MHz LO in the IF Section. The three voltages are:

- a. Center frequency control — corresponds to dial frequency, set by FREQUENCY and FINE TUNE knobs.
- b. Ramp control — determines width of frequency scan, set by SCAN WIDTH knobs.
- c. Zero adjustment — compensates for drift in IF Section 47 MHz LO, set by ZERO ADJ knob.

Center Frequency Control Circuits

The output of tune amplifier A7U4 can be set from 0 to +15 V by the FREQUENCY and FINE TUNE knobs; this corresponds to dial settings of 0 to 300 kHz. 300 kHz ADJ R5 sets dial accuracy at 300 kHz. OFFSET ADJ A7R13 is used to set the amplifier's output to 0 V when the dial is at 0 Hz.

When RANGE kHz switch S3 is set to 0-30, it adds a voltage divider to the output of A7U4. This divider divides A7U4's output by 10; a 0 to 1.5 V swing corresponds to dial settings of 0 to 30 kHz.

When SCAN WIDTH is set to ZERO and PER DIVISION, A7U4's output is fed to A7U5 and on to the IF Section 47 MHz LO control circuits. When SCAN WIDTH is set to 0-10f the voltage sent to the IF Section through A7U5 is determined by PER DIVISION switch S1-4F (more about A7U5 below).

Ramp Control Circuits

When SCAN WIDTH is set to ZERO, the ramp from the IF Section scan circuits is disabled by S2-IF, and scan-offset amplifier output is 0 V. This prevents the IF Section 47 MHz LO from being swept (however, its frequency is still set by the center frequency control circuits).

When SCAN WIDTH is set to PER DIVISION or 0-10f, the -5 V to +5 V ramp from the IF Section scan circuits is fed to scan-offset amplifier A7U8. In PER DIVISION the scan-offset amplifier has unity gain so its output is a -5 V to +5 V ramp. This ramp is fed to the scan width attenuator and on to the IF Section 47 MHz LO control circuits. The amplitude of the ramp determines the frequency range over which the 47 MHz LO is swept.

When SCAN WIDTH is set to 0-10f and PER DIVISION is set to 10 kHz or less, A7U8 is offset 5 V. This offsets the ramp so that it sweeps from 0 to +10 V. The 0 to +10 V ramp is then sent through the scan width attenuator to the IF Section. The offset ramp will sweep the 47 MHz LO from 0 Hz to a frequency determined by the ramp's amplitude. To prevent control of the 47 MHz LO by the frequency control circuits the input to the voltage follower amplifier A7U5 is referenced to 0 V.

When SCAN WIDTH is set to 0-10f and PER DIVISION is set to 20 kHz, the offset is applied to voltage follower amplifier A7U5. Scan-offset amplifier A7U8 is not offset and its output is a -5 V to +5 V ramp. In all other respects operation is as described when PER DIVISION is set to 10 kHz or less.

Zero Adjustment Circuit

ZERO ADJ pot R6 is in a divider network from +20 V to ground. It can change the 47 MHz LO in the HP 8552B about 24 kHz, and in the HP 8552A about 54 kHz. When the LF Section is connected to an HP 8552B, P3 pin 15 is connected to +20 V; P3 pin 15 is open when connected to an HP 8552A. This compensates for operating differences between the IF Sections.

TROUBLESHOOTING

Equipment:

- Oscilloscope HP 180A/1801A/1820B
- X10 Oscilloscope Probe HP 10004A
- Digital Voltmeter HP 3480B/3484A Option 042
- Cable Assy HP 11102A
- Extender Cable Assy HP 11592-60015
- Extender Board HP 5060-0256

General

Normally trouble is isolated to the Frequency Control and Marker Generator Assembly A6 using the overall troubleshooting tree or the troubleshooting block diagram. Isolate trouble to the circuit level using the troubleshooting tree and procedures outlined below.

Extend the LF and IF Sections on the extender cables; remove the A7 assembly from the chassis and re-install it on the extender board.

Center Frequency Control Circuits

Connect Digital Voltmeter to test point A (A11XA7 pin 5) and set analyzer controls as follows:

- FREQUENCY 0 kHz (set accurately)
- FINE TUNE Centered
- BANDWIDTH 100 Hz
- SCAN WIDTH PER DIVISION
- PER DIVISION 10 kHz
- RANGE 0-300 kHz

The voltmeter should read 0.0 ±5.0 mVdc. If not, adjust OFFSET ADJ (A7R13) until it does.

Tune FINE TUNE from full clockwise to full counter-clockwise; the voltage at test point A should swing about 50 ± 5 mVdc. Re-center FINE TUNE.

Set FREQUENCY to 300 kHz. Tune 300 kHz ADJ (on front panel) from full clockwise to full counter-clockwise; the voltage at test point A should swing from 15.50 to 15.85 Vdc.

Adjust 300 kHz ADJ until voltage at test point A is +15.40 V. (Factory select value A1R1 sets 300 kHz ADJ range, see Table 8-1.) Switch RANGE to 0-30 kHz; the voltage should be +1.540 ±0.008 V.

Set RANGE to 0-300 kHz and connect voltmeter to test point B (A11XA7 pin 8); the voltage should be +15.40 ±.01 V. Set SCAN WIDTH to 0-10f; the voltage should decrease to 0.0 ±.01 V. Set PER DIVISION to 20 kHz; the voltage should be +5.00 ±0.05 V.

If checks indicate center frequency control circuit malfunction A7U4, U5 and associated circuitry.

After repairing center frequency control circuits, perform calibration adjustment procedure specified in paragraph 5-28.

NOTE

After replacing the frequency tuning pot R3, perform dial calibration procedure in paragraph 8-70.

Ramp Control Circuits

Connect Digital Voltmeter to test point C (A11XA7 pin L) and controls as follows:

- SCAN WIDTH PI
- PER DIVISION
- SCAN TIME PER DIVISION 5 MII
- SCAN MODE
- SCAN TRIGGER

The voltage at test point C should be -5.00 ±0.01 V. Set SC INT and connect Oscilloscope (with X10 probe) to test point should be 10 V p-p sawtooth as shown on schematic. If checks above are bad, check scan generator circuits in IF Section.

Set SCAN WIDTH to 0-10f, Scan MODE to SINGLE and connect to test point D (A11XA7 pin 10). The voltmeter should read - Set PER DIVISION to 10 kHz; the voltmeter should read 0.0 ±

Set SCAN WIDTH to PER DIVISION, PER DIVISION to connect voltmeter to test point E (934 wire at A2S1 lug 12). should read as indicated for the following scan widths:

PER DIVISION	Voltmeter reading
20 kHz	-5.000 ±0.050 V
10 kHz	-2.500 ±0.025 V
5 kHz	-1.250 ±0.013 V
2 kHz	-500.0 ±5.0 mV
1 kHz	-250.0 ±2.5 mV
500 Hz	-125.0 ±1.3 mV
200 Hz	-50.00 ±0.50 mV
100 Hz	-25.00 ±0.25 mV
50 Hz	-12.50 ±0.14 mV
20 Hz	-5.00 ±0.07 mV

If checks indicate ramp control circuit malfunction, check A7U attenuator and associated circuits. After repairing ramp control perform frequency calibration adjustment procedure specified 5-28.

SERVICE SHEET 9 (cont'd)

Zero Adjustment Circuit

Set analyzer as follows:

FREQUENCY 0 kHz
 FINE TUNE Centered
 BANDWIDTH 3 kHz
 SCAN WIDTH PER DIVISION
 PER DIVISION 10 kHz
 INPUT LEVEL -10 dBm/dBV
 BASE LINE CLIPPER ccw
 VIDEO FILTER OFF
 SCAN TIME PER DIVISION 5 MILLISECONDS
 LOG/LINEAR 10 dB LOG
 LOG REF LEVEL -10 dBm/dBV
 SCAN MODE INT
 SCAN TRIGGER AUTO

Tune ZERO ADJ (on front panel) from full counter-clockwise to full clockwise. The LO feedthrough signal on the CRT should shift as follows:

- with 8552A IF Section, 54 ± 2 kHz
- with 8552B IF Section, 24 ± 2 kHz

If not, check R6, ZERO ADJ pot and associated circuitry. After repairing zero adjustment circuit, perform frequency calibration adjustment procedure specified in paragraph 5-28.

Troubleshooting Tree

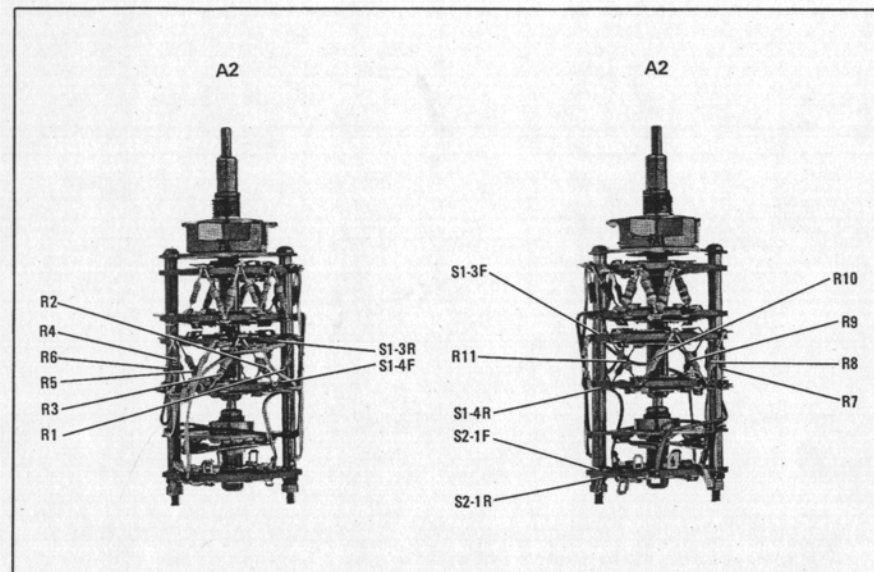
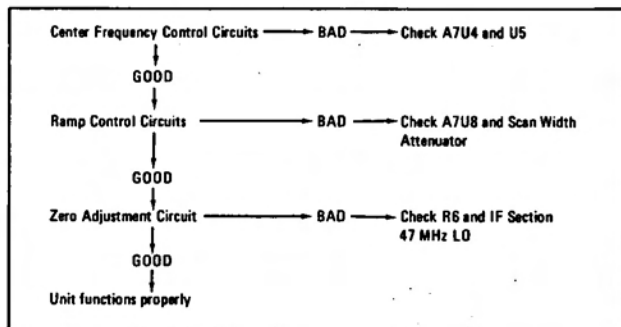


Figure 8-36. Scan Width Switch Assembly A2 Component Locations

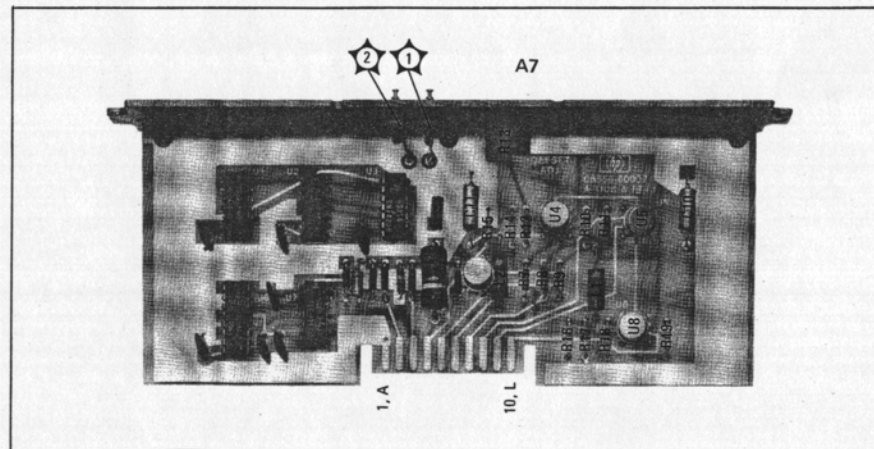
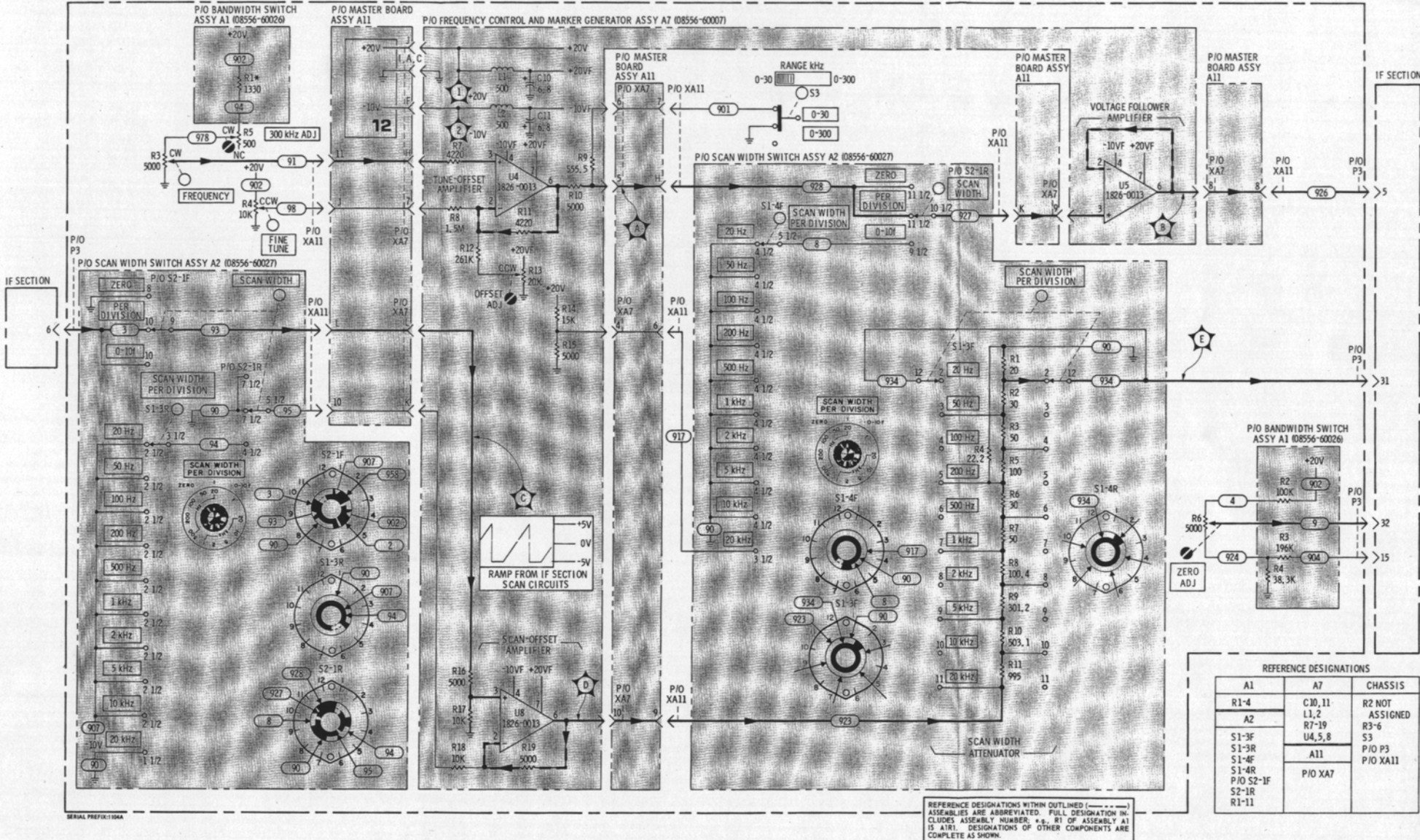


Figure 8-37. Frequency Control and Marker Generator Assy A7 Component Locations



REFERENCE DESIGNATIONS

A1	A7	CHASSIS 1
R1-4	C10, 11 L1, 2	R2 NOT ASSIGNED
A2	R7-19	R3-6
S1-3F S1-3R S1-4F S1-4R P/O S2-1F S2-1R R1-11	U4, 5, 8 A11 P/O XA7	S3 P/O P3 P/O XA11

REFERENCE DESIGNATIONS WITHIN OUTLINED (---) ASSEMBLIES ARE ABBREVIATED. FULL DESIGNATION INCLUDES ASSEMBLY NUMBER, e.g. BT OF ASSEMBLY A1 IS A1R1. DESIGNATIONS OF OTHER COMPONENTS ARE COMPLETE AS SHOWN.

Figure 8-38. Frequency Control Circuits: A1

SERVICE SHEET 10

THEORY OF OPERATION

The DISPLAY UNCAL lamp DS1 illuminates when SCAN WIDTH DIVISION, BANDWIDTH, SCAN TIME and VIDEO FILTER are a combination of positions which does not permit accurate calibration (see Figure 8-39). The DISPLAY UNCAL lamp is illuminated by a simulated signal and has no actual connection to signal processing circuitry.

The LF Section Scan Width Switch Assembly A2 and Bandwidth Switch Assembly A1 both have switch wafers devoted exclusively to analog. In the IF Section the Scan Time Switch Assembly and Video Filter Switch Assembly have analog wafers.) When SCAN WIDTH is set to PER DIV, current is added to the two buss lines (956 and 957) BANDWIDTH and PER DIVISION. In the IF Section this current is added with the current added by SCAN TIME and VIDEO FILTER. A current on either buss line is high enough to bias the light driver section into conduction, it turns on and lights the DISPLAY UNCAL lamp (see Service Sheet 12). When SCAN WIDTH is set to ZERO, the circuit is disabled.

TROUBLESHOOTING

Equipment:

Digital Voltmeter HP 3480B/3484A
Cable Assy HI

General

When trouble has been isolated to the LF Section analog, perform the following checks;

Remove the LF and IF Sections from the Display Section and disconnect the LF Section from the IF Section. Remove the top and bottom covers from the LF Section.

Unsolder the 2 white-green-blue (956) wires from lug 5½ of S1-1R. Unsolder the white-green-violet (957) wires from lug 6 of S1-1F of Bandwidth Switch Assembly A1.

Bandwidth Switch Resistance Measurement

With 956 and 957 wires removed, and LF Section disconnected from the Display Section, measure resistance from lug 5½ (where 956 wire was connected) to lug 7 of S1-2F (where 957 wire was connected). Also, measure resistance from lug 6½ of S1-1F (where 957 wire was connected) to lug 7 of S1-2F.

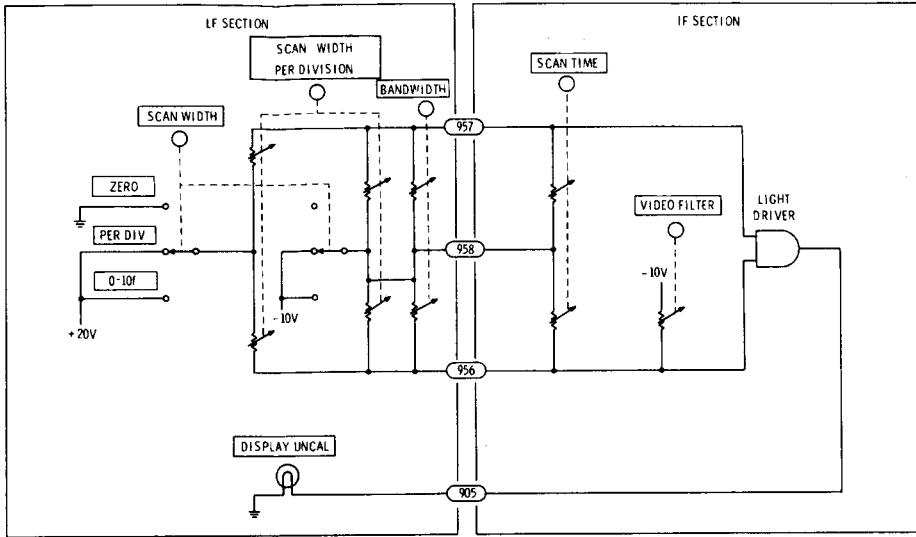


Figure 8-39. Simplified Analog Diagram

SERVICE SHEET 10 (cont'd)

Resistance should be within 2% of values tabulated below for each BANDWIDTH position.

BANDWIDTH	Resistance (k Ω) ± 2%	
	S1-1R, lug 5½ to S1-2F, lug 7	S1-1F, lug 6 to S1-2F, lug 7
10 kHz	48.33	31.22
3 kHz	43.25	26.13
1 kHz	39.85	22.73
300 Hz	37.35	20.28
100 Hz	35.54	18.46
30 Hz	34.13	17.04
10 Hz	44.78	14.04

Scan Width Switch Resistance Measurement

With 956 and 957 wires removed from Bandwidth Switch Assembly A1, and LF Section disconnected from IF Section and Display Section, measure resistance from Scan Width Switch Assembly A2 lug 6 of S1-2F (where 956 wire is connected) to lug 2 of S2-1F (where 958 wire is connected). Also, measure resistance from lug 5 of S1-2R (where 957 wire is connected) to lug 2 of S2-1F.

Resistance should be within 2% of values tabulated below for each SCAN WIDTH PER DIVISION position.

SCAN WIDTH PER DIVISION	Resistance (k Ω) ± 2% For Both Measurements
20 kHz	61.78
10 kHz	67.24
5 kHz	74.88
2 kHz	86.30
1 kHz	106.1
500 Hz	144.8
200 Hz	260.8
100 Hz (and below)	open (OVER RANGE)

Measure resistance from lug 6 of S1-2F (where 956 wire is connected) to lug 5 of S2-1F (where 2 wire is connected). Also, measure resistance from lug 5 of S1-2R (where 957 wire is connected) to lug 5 of S2-1F.

Resistance should be within 2% of values tabulated below for each SCAN WIDTH PER DIVISION position.

SCAN WIDTH PER DIVISION	Resistance (k Ω) ± 2% For Both Measurements
100 Hz (and above)	open (OVER RANGE)
50 Hz	483.3
20 Hz	256.0

Make any necessary repairs, re-solder 956 and 957 wires to Bandwidth Switch Assembly A1, and perform analogic checks as specified in paragraph 5-29.

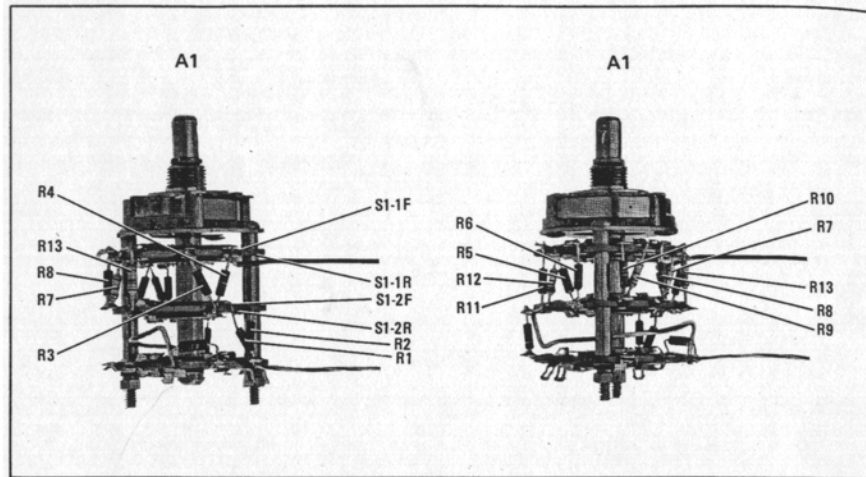


Figure 8-40. Bandwidth Switch Assembly A1 Component Locations

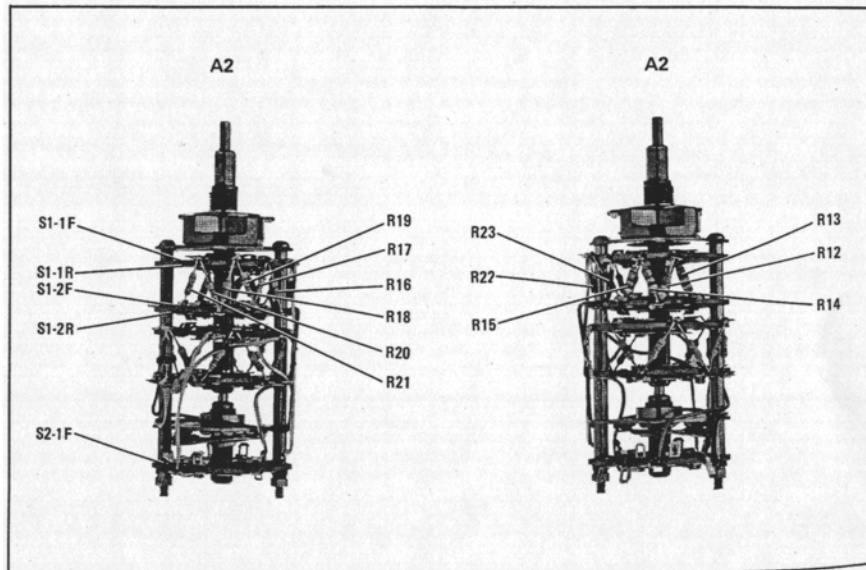
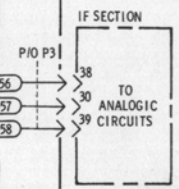
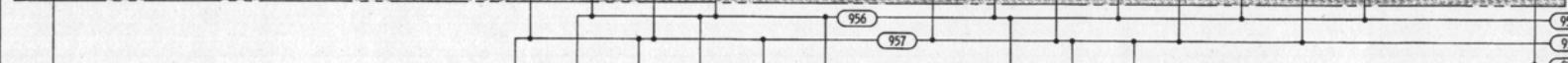
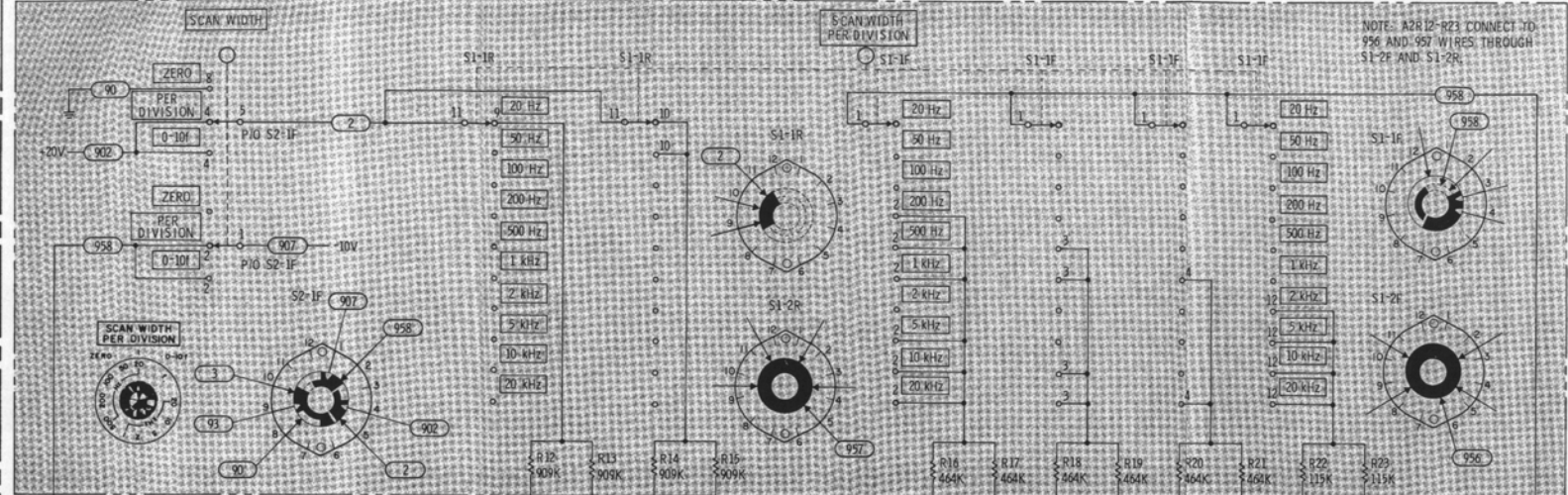
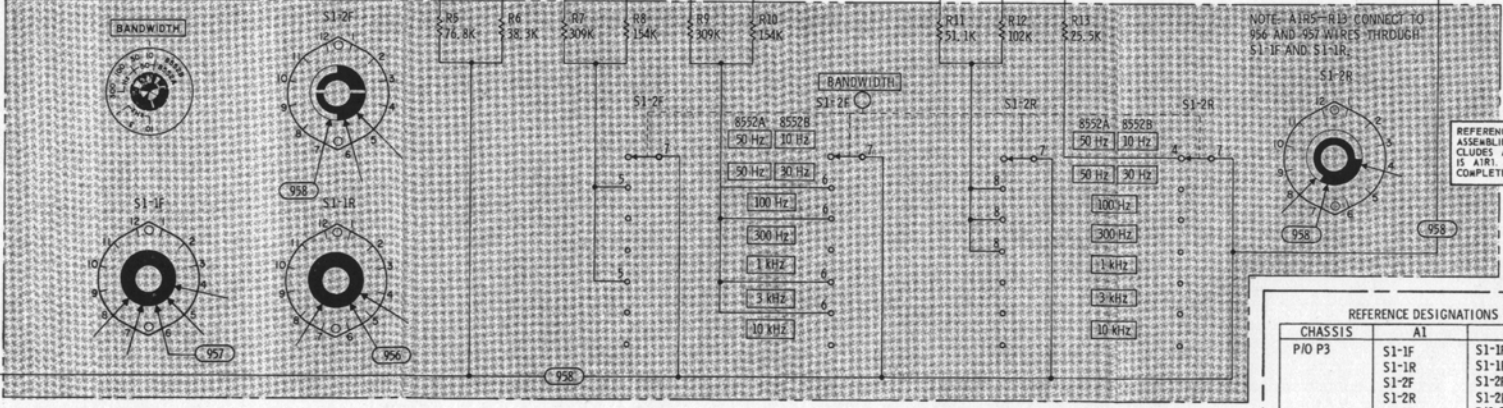


Figure 8-41. Scan Width Switch Assy A2 Component Locations

P/O SCAN WIDTH SWITCH ASSY A2 (08556-60027)



P/O BANDWIDTH SWITCH ASSY A1 (08556-60026)



REFERENCE DESIGNATIONS WITHIN OUTLINED ASSEMBLIES ARE ABBREVIATED. FULL DESIGNATION INCLUDES ASSEMBLY NUMBER, e.g., R1 OF ASSEMBLY A1 IS A1R1. DESIGNATIONS OF OTHER COMPONENTS ARE COMPLETE AS SHOWN.

REFERENCE DESIGNATIONS

CHASSIS	A1	A2
P/O P3	S1-1F	S1-1F
	S1-1R	S1-1R
	S1-2F	S1-2F
	S1-2R	S1-2R
	P/O S2-1F	
	R12-23	

Figure 8-42. Analogic Circuits: A1 and A2

SERVICE SHEET 11

THEORY OF OPERATION

The AMPL CAL pot controls a calibration amplifier in the IF Section. The calibration amplifier is used to calibrate the analyzer's absolute amplitude. See the 3 MHz IF Amplifier circuit description in the IF Section manual.

Input Level Switch

Two wafers of the Input Level Switch Assembly A3 control circuits in the IF Section. S1-2R lights index lamps on the LOG REF LEVEL switch. S1-3R is part of the linear gain compensation network; see the Log/Linear Amplifier circuit description in the IF Section manual.

Bandwidth Switch

The portion of the Bandwidth Switch Assembly shown provides positive or negative voltages that select and bypass bandwidth circuits in the IF Section. See the bandwidth circuit descriptions in the IF Section manual.

TROUBLE SHOOTING

Equipment:

- Digital Voltmeter HP 3480B/3484A Option 042
- Cable Assy HP 11002A
- Extender Cable Assy HP 11592-60015
- Interconnection Cable Assy HP 11592-60016

Normally trouble is isolated to the IF Section control circuits after troubleshooting the IF Section. Isolate trouble to a specific component using the Digital Voltmeter to check the voltages and resistances shown on the schematic.

Extend the LF and IF Sections on the extender cables; separate the LF Section from the IF Section and install the interconnection cable. Check and, if necessary, repair the components and assemblies shown.

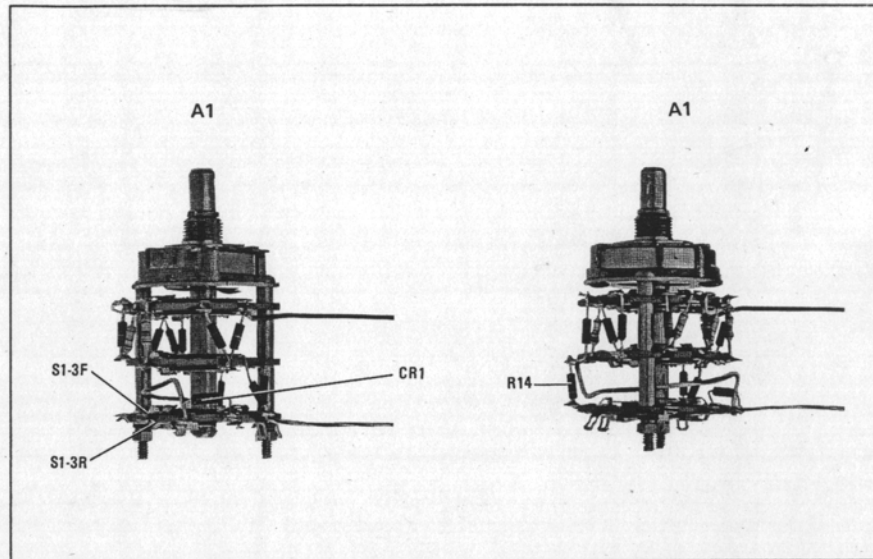


Figure 8-43. Bandwidth Switch Assembly A1 Component Locations

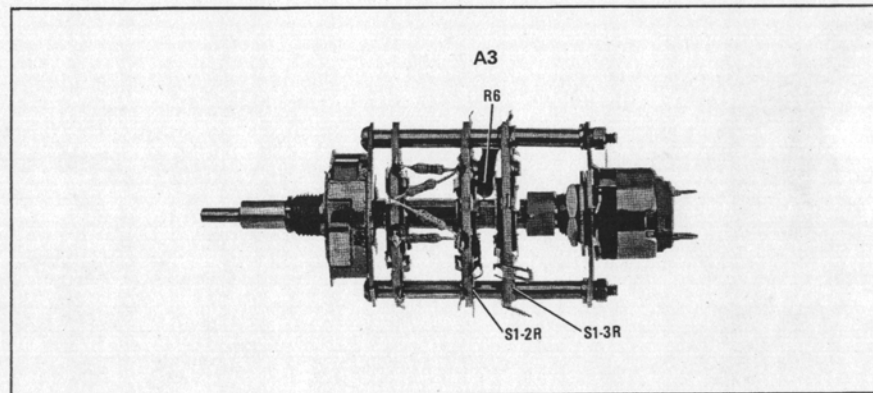
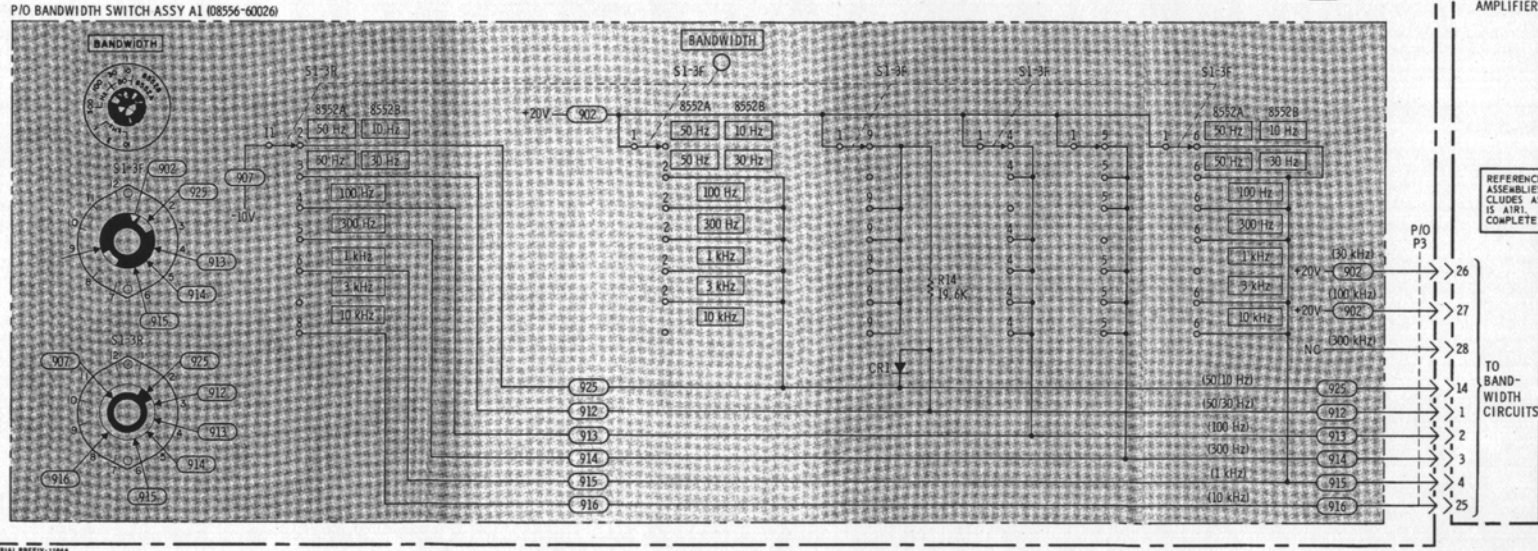
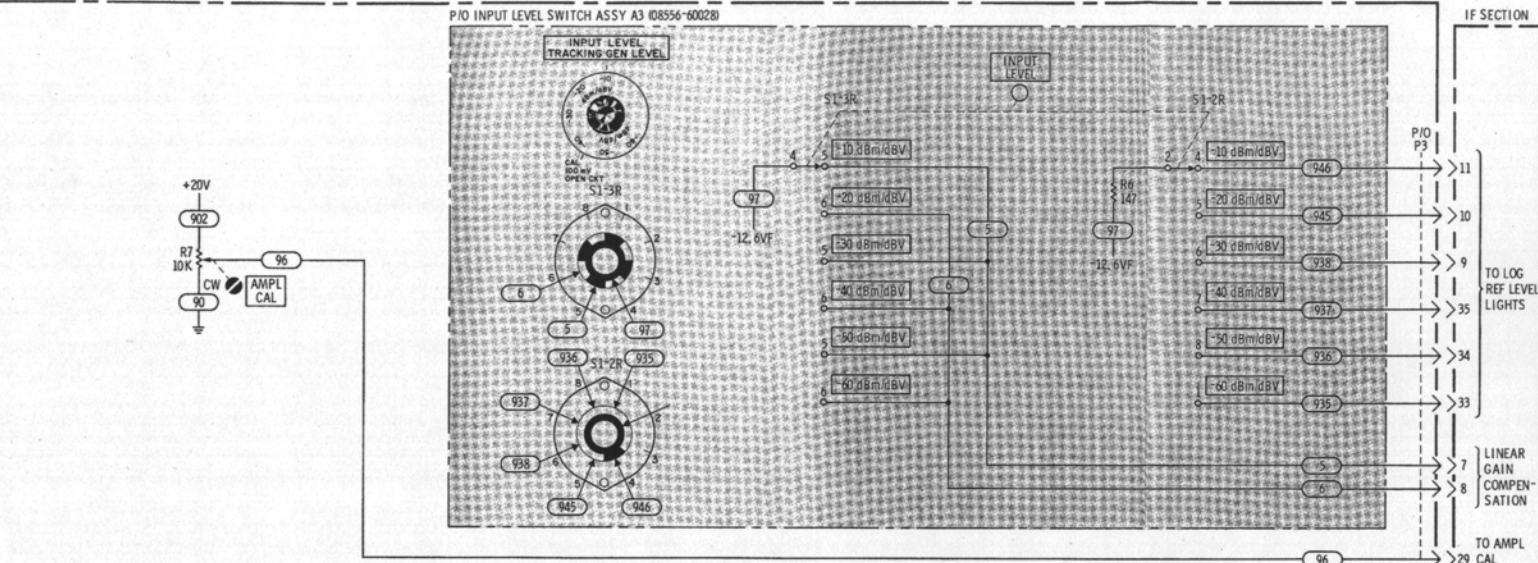


Figure 8-44. Input Level Switch Assembly A3 Component Locations



REFERENCE DESIGNATIONS WITHIN OUTLINED (---) ASSEMBLIES ARE ABBREVIATED. FULL DESIGNATION INCLUDES ASSEMBLY NUMBER, e.g., R1 OF ASSEMBLY A1 IS, A1R1. DESIGNATIONS OF OTHER COMPONENTS ARE COMPLETE AS SHOWN.

REFERENCE DESIGNATIONS

A1	A3
S1-3F	S1-2R
S1-3R	S1-3R
CR1	R6
R14	CHASSIS
	R7
	P/O P3



Figure 8-45. IF Section Control Circuits: A1 and A.

SERVICE SHEET 12

THEORY OF OPERATION

General

The sources for the supply voltages used in the LF Section are shown.

Isolated Power Supply

The Pre-Attenuator and Preamplifier Assembly A5 (see Service Sheet 4) is isolated from chassis ground. The Power Supply Assembly A10 provides isolated supply voltages for the preamplifier and an isolated ground for all of the input circuitry. This prevents line related signals being introduced into the input signal path.

A10Q1 and Q2 saturate, in turn, and send current ramps through the primary windings of A10T1. The switching rate of Q1 and Q2 is about 500 kHz. The current ramps induce a voltage in the secondary of T1. The voltage is rectified by the bridge rectifier, filtered and sent to the master board. On the master board the voltages are again filtered and fed to the preamplifier. A11R6 is a bleeder resistor that prevents static charges from building up in the isolated circuits.

TROUBLE SHOOTING

Equipment:

Oscilloscope	HP 180A/1801A/1820B
X10 Oscilloscope Probe	HP 10004A
Digital Voltmeter	HP 3480B/3484A Option 042
Cable Assy	HP 11002A
Extender Cable Assy	HP 11592-60015
Interconnection Cable Assy	HP 11592-60016
Extender Board	HP 5060-0256

General

Normally trouble is isolated at the Power Supply Assembly A10 and the voltage distribution circuits using the overall troubleshooting tree or the troubleshooting block diagram. Isolate trouble to a specific circuit using the procedures outlined below. The voltages listed on the schematic should assist in isolating trouble to a specific component.

Extend the LF and IF Sections on the extender cables; separate the LF Section from the IF Section and install the interconnection cable. Remove the A10 assembly from the chassis and re-install it on the extender board.

Isolation

Remove Pre-Attenuator and Preamplifier Assembly A5 from chassis. Connect Digital Voltmeter from A5 assembly cover to chassis ground and measure resistance. It should be about 100 k ohms. If not, remove A10 assembly from chassis and re-check. If resistance is about 100 k ohms with A10 removed, check A10T1, bridge rectifier, and filter on A10 assembly. If resistance is less than 100 k ohms with A10 removed, check filter circuits on Master Board Assembly A11 (some of these circuits are shown on Service Sheet 4).

Isolated Power Supply

Connect Oscilloscope (with X10 probe) to test point 1. Waveform should be as shown on schematic: 400 to 600 kHz, 25 to 30 V p-p. If not, check 400-600 kHz oscillator (A10Q1, Q2 and associated circuitry).

Connect Digital Voltmeter across +20 VI and -20 VI test points on Pre-Attenuator and Preamplifier Assembly A5. The voltage should be 40 ± 4 V dc. If not, check bridge rectifier and filter circuits.

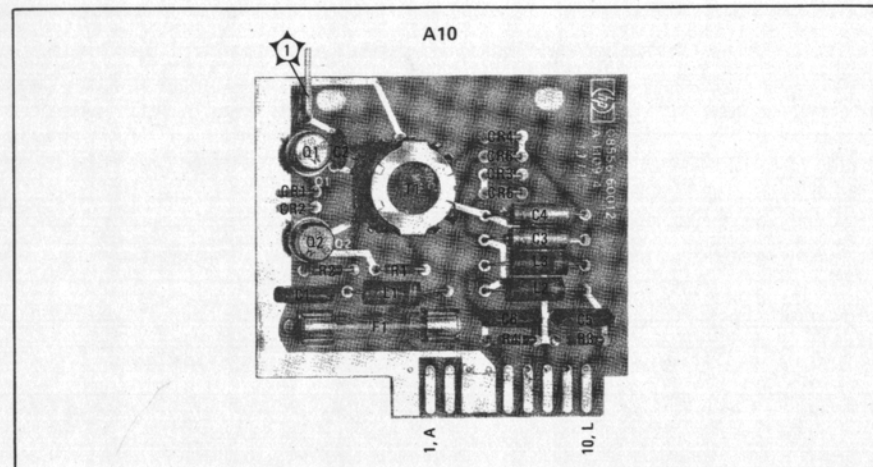


Figure 8-46. Power Supply Assembly A10 Component Locations

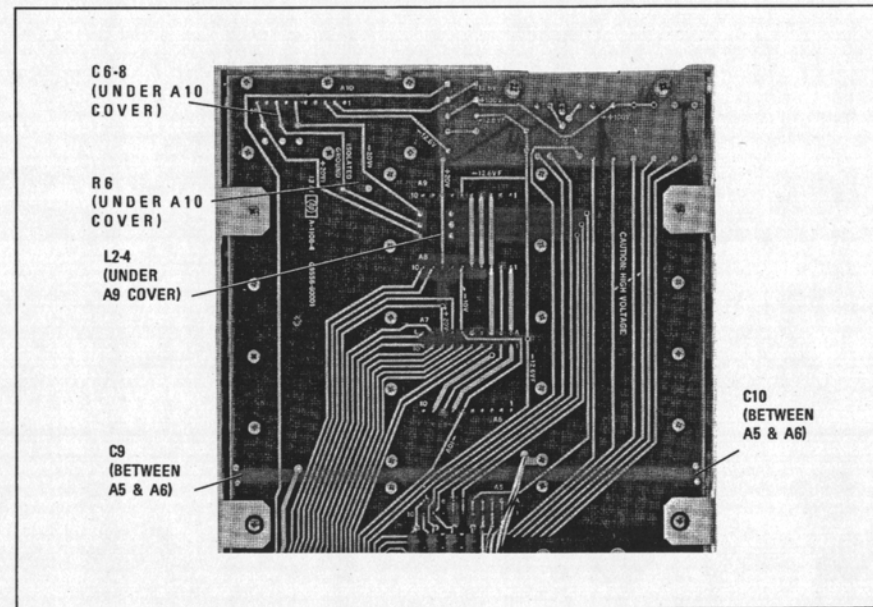


Figure 8-47. Master Board Assy A11 Component Locations

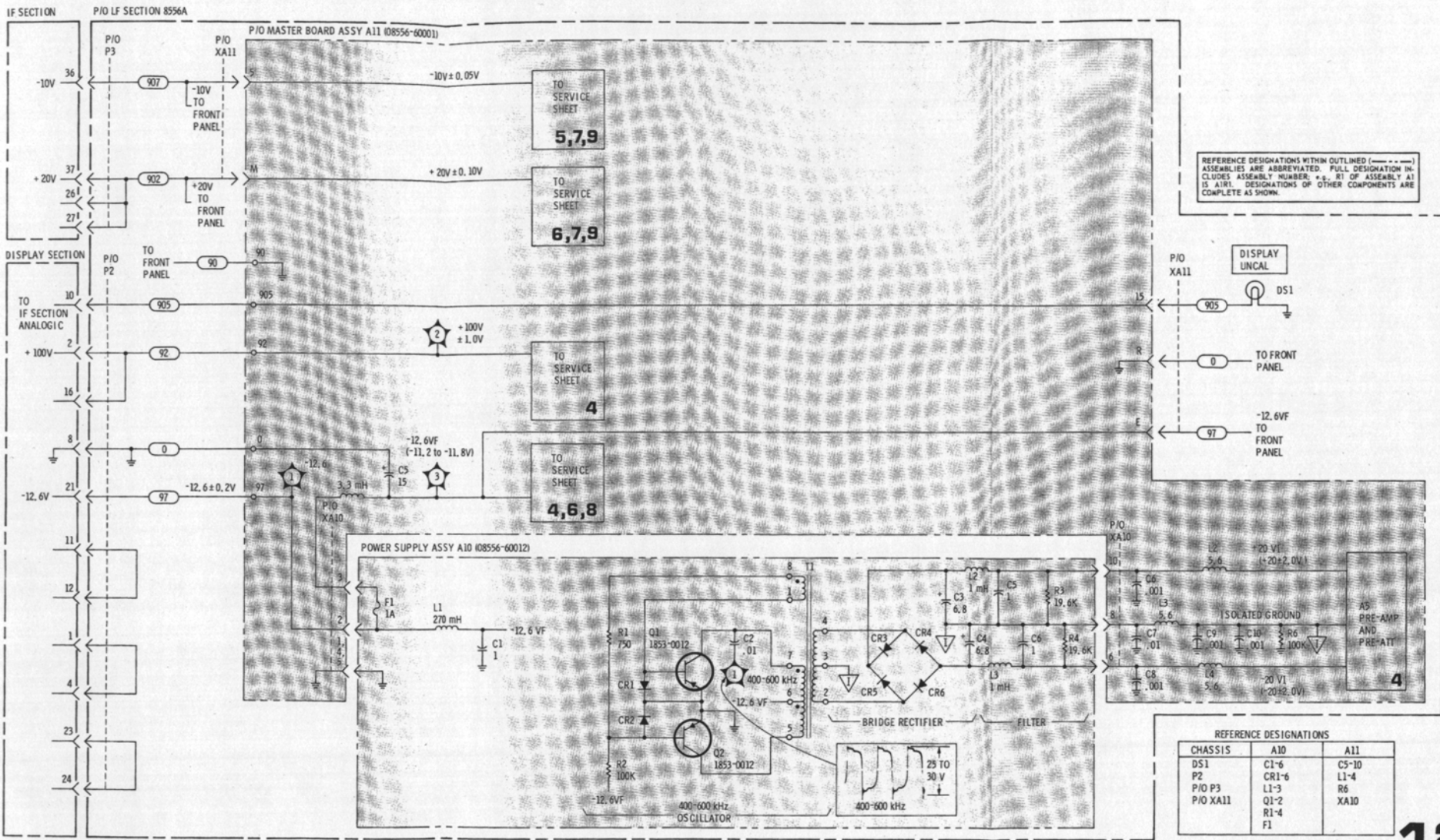


Figure 8-48. Power Supply and Voltage Distribution: A10 and A11