

UNCLASSIFIED
REFERENCE COPY

TM 11-4009

WAR DEPARTMENT TECHNICAL MANUAL

REFERENCE COPY

RADIO RECEIVER AND
TRANSMITTER BC-1306
REPAIR INSTRUCTIONS

UNCLASSIFIED by W.D. Circe 231, 1945-

RESTRICTED. DISSEMINATION OF RESTRICTED MATTER.
No person is entitled solely by virtue of his grade or position
to knowledge or possession of classified matter. Such matter
is entrusted only to those individuals whose official duties
require such knowledge or possession. (See also paragraph
23b, AR 380-5, 15 March 1944.)

REFERENCE COPY

WAR DEPARTMENT

MAY 1945

UNCLASSIFIED

WAR DEPARTMENT TECHNICAL MANUAL

TM 11-4009

RADIO RECEIVER AND
TRANSMITTER BC-1306
REPAIR INSTRUCTIONS



WAR DEPARTMENT

MAY 1945

UNCLASSIFIED

RESTRICTED. DISSEMINATION OF RESTRICTED MATTER.

No person is entitled solely by virtue of his grade or position to knowledge or possession of classified matter. Such matter is entrusted only to those individuals whose official duties require such knowledge or possession.

(See also paragraph 23b, AR 380-5, 15 March 1944.)

United States Government Printing Office

Washington: 1945

Downloaded by
RadioManual.EU

WAR DEPARTMENT

Washington 25, D. C., 28 May 1945

TM 11-4009, Radio Receiver and Transmitter BC-1306, Repair Instructions, is published for the information and guidance of all concerned.

[AG 300.7 (18 Apr 45)]

BY ORDER OF THE SECRETARY OF WAR:

OFFICIAL:

J. A. ULIO
Major General
The Adjutant General

G. C. MARSHALL
Chief of Staff

DISTRIBUTION:

AAF (5); AGF (5); ASF (2); T of Opn (5); Dept (5); Def Comd (2); Base Comd (5); AAF Comd (2); Arm & Sv Bd (1); S Div ASF (1); Tech Sv (2); SvC (5); Area ASVC (2); WDGS Lib (5); PC&S (2); PE (2); Dep 11 (2); Gen Oversea SOS Dep (Sig Sec) (2); GH (2); M Conc C (2); Air Base Hosp (2); Gen Sv Sch (5); Sp Sv Sch (10); USMA (2); ROTC (5); Lab 11 (2); Sig AS (2); Rep Shop 11 (2); A (5); D (2); AF (2); Three (3) copies to each of the following: T/O & E 11-7; 11-15; 11-47; 11-107; 11-127; 11-147; 11-500, Sig Sv Orgn—(EG); 11-587; 11-592; 11-597.

Refer to FM 21-6 for explanation of distribution formula.

RESTRICTED

WARNING

HIGH VOLTAGE

is used in the operation of
this equipment

DEATH ON CONTACT

may result if operating personnel
fail to observe safety precautions.

CONTENTS

	<i>Paragraph</i>	<i>Page</i>
SECTION I. DESCRIPTION OF RADIO RECEIVER AND TRANSMITTER BC-1306.		
General	1	1
Theory of operation.....	2	1
SECTION II. DIFFERENCES BETWEEN MODELS.(Not applicable.)		
SECTION III. INITIAL REPAIR PROCEDURES.		
General	3	5
Tools, test and cleaning equipment.....	4	5
Disassembly of receiver for cleaning, inspecting, and lubricating.....	5	6
Cleaning, inspecting, and lubricating of receiver chassis.....	6	7
Cleaning, inspecting, and testing of removed parts (receiver).....	7	7
Repair or replacement of defective parts (receiver).....	8	8
Reassembly of removed parts (receiver).....	9	8
Disassembly of transmitter for cleaning, inspecting, and lubricating.....	10	8
Cleaning, inspecting, and lubricating of transmitter chassis.....	11	8
Cleaning, inspecting, and testing of removed parts (transmitter).....	12	9
Repair or replacement of defective parts (transmitter).....	13	9
Reassembly of removed parts (transmitter).....	14	12
SECTION IV. PRELIMINARY TROUBLE-SHOOTING PROCEDURES.		
Input resistance and cable continuity checks.....	15	14
Operational tests	16	16
SECTION V. ALIGNMENT PROCEDURE.		
General	17	20
Receiver	18	20
Transmitter	19	22
SECTION VI. DETAILED TROUBLE-SHOOTING PROCEDURES.		
General	20	25
Receiver second i-f amplifier and audio stages.....	21	25
Receiver radio-frequency and converter stages.....	22	25
Transmitter r-f stages	23	26
Moistureproofing, fungiproofing, and refinishing.....	24	26
SECTION VII. FINAL TESTING.		
Alignment check	25	27
Final testing (transmitter)	26	27
Final testing (receiver)	27	30

SECTION VIII. INDIVIDUAL STAGE AND CIRCUIT REPAIR DATA.

Receiver r-f amplifier stage.....	28	34
Receiver mixer, h-f oscillator stage.....	29	36
Receiver first i-f amplifier stage.....	30	38
Receiver second i-f amplifier and crystal calibrator stage.....	31	40
Receiver detector, first a-f amplifier, a-v-c, bfo stage.....	32	42
Receiver audio-output amplifier stage.....	33	44
Receiver power and switching connections.....	34	46
Transmitter oscillator stage	35	48
Transmitter p-a stage	36	52
Transmitter antenna-tuning network stage.....	37	56
Transmitter modulator stage	38	58
Transmitter power and switching circuits.....	39	60

SECTION IX. SUPPLEMENTARY DATA.

Removal and replacement of ganged tuning capacitor (transmitter).....	40	66
Noise and distortion in receiver.....	41	67

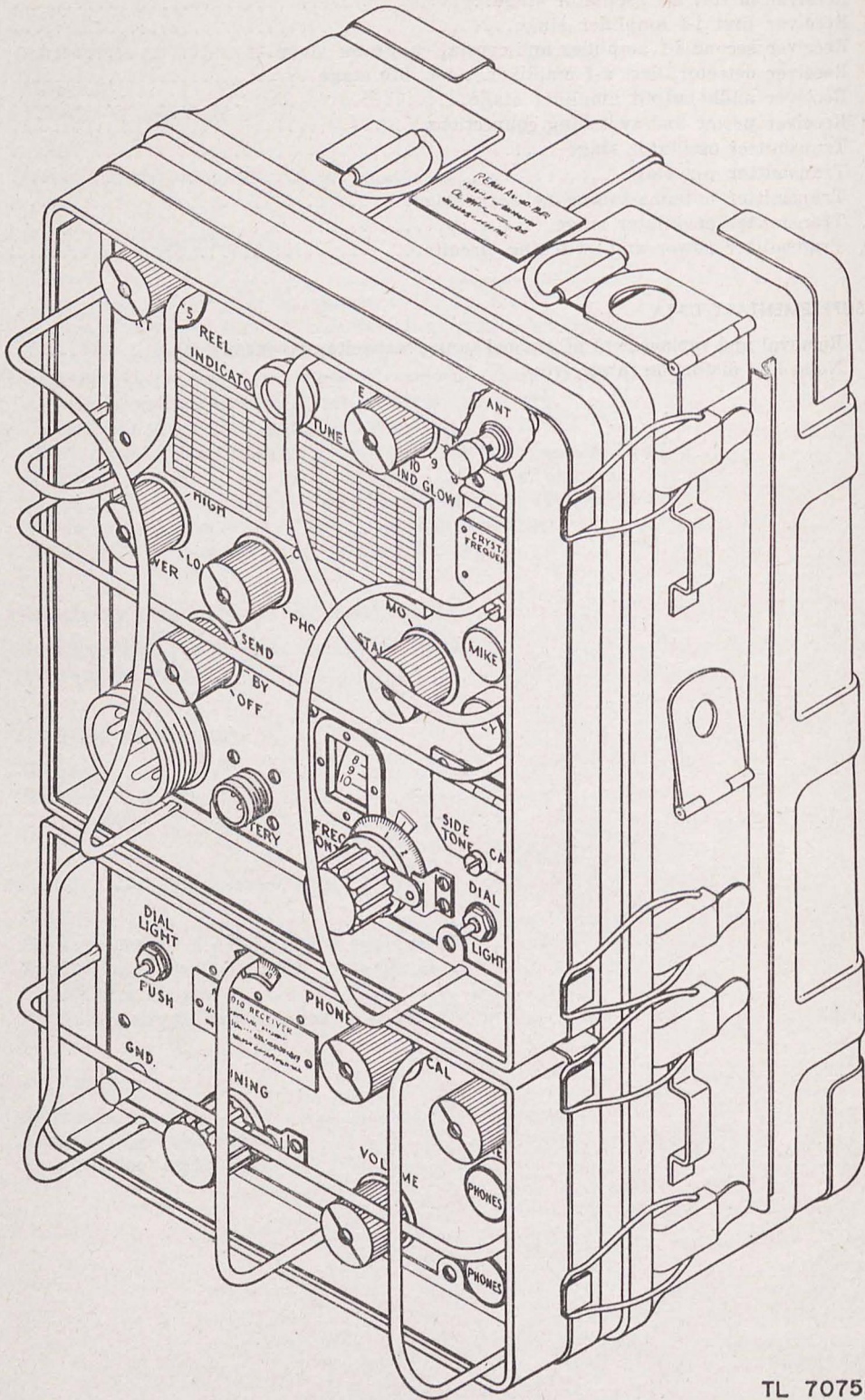

TL 70751

Figure 1. Radio Receiver and Transmitter BC-1306.

SECTION I

DESCRIPTION OF RADIO RECEIVER AND TRANSMITTER BC-1306*

I. General

a. USE. Radio Receiver and Transmitter BC-1306 is the basic component of a two-way telephone (phone) and radiotelegraph c-w (continuous-wave) set, designed to provide communication between moving or stationary vehicles, or as a portable field set. (See fig. 1.) Radio Receiver and Transmitter BC-1306 will transmit and receive amplitude-modulated radio telephone, and tone-modulated radiotelegraph (modulated-continuous-wave) signals. All types of transmission are master-oscillator-controlled or crystal-controlled.

b. FREQUENCY RANGE. Radio Receiver and Transmitter BC-1306 covers the frequency range of 3,800 to 6,500 kc (kilocycles). Crystals used in the transmitter operate at one-half the transmitted frequency.

c. OPERATING RANGE. Transmission and reception of voice communication up to 15 miles and radiotelegraph signals up to 30 miles may be secured.

d. POWER INPUT. The power necessary for operation of the transmitter and receiver is secured from a hand-driven Generator GN-58, or a gasoline engine-driven Power Unit PE-162, or Vibrator Power Unit PE-237, using appropriate cables. Power necessary to operate the

receiver alone or STANDBY of the transmitter is provided by Battery BA-48, using Cord CD-1119.

e. POWER OUTPUT. The power output of the transmitter varies over wide limits, depending upon the type of power unit used and the position of the POWER switch 137. The normal power output under these various conditions is given in the following table:

Table I

Power Switch	Vibrator Power Unit PE-237		Generator GN-58	
	Phone	CW	Phone	CW
High	8.5 watts	25 watts	6 watts	17 watts
Medium	4.5 watts	21 watts	4 watts	14 watts
Low	2.2 watts	13 watts	2 watts	8.5 watts

Note. Vacuum-tube tolerances may decrease these outputs by 20 percent.

2. Theory of Operation

a. GENERAL. Radio Receiver and Transmitter BC-1306 may be rapidly switched manually from receive to transmit positions, using the same antenna system for transmission and reception. The receiver dial is directly calibrated in megacycles while the transmitter dial is calibrated 0 to 3,000. The signal path through the receiver and transmitter respectively, is shown in block diagram. (See figs. 2 and 3.)

*Refer to TM 11-230C for installation, operation, and other maintenance data on this equipment.

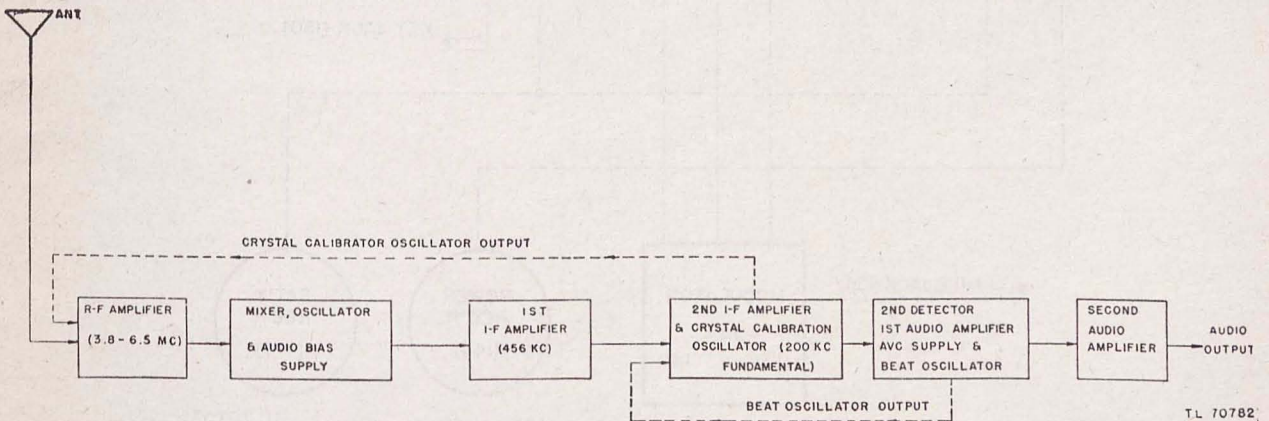
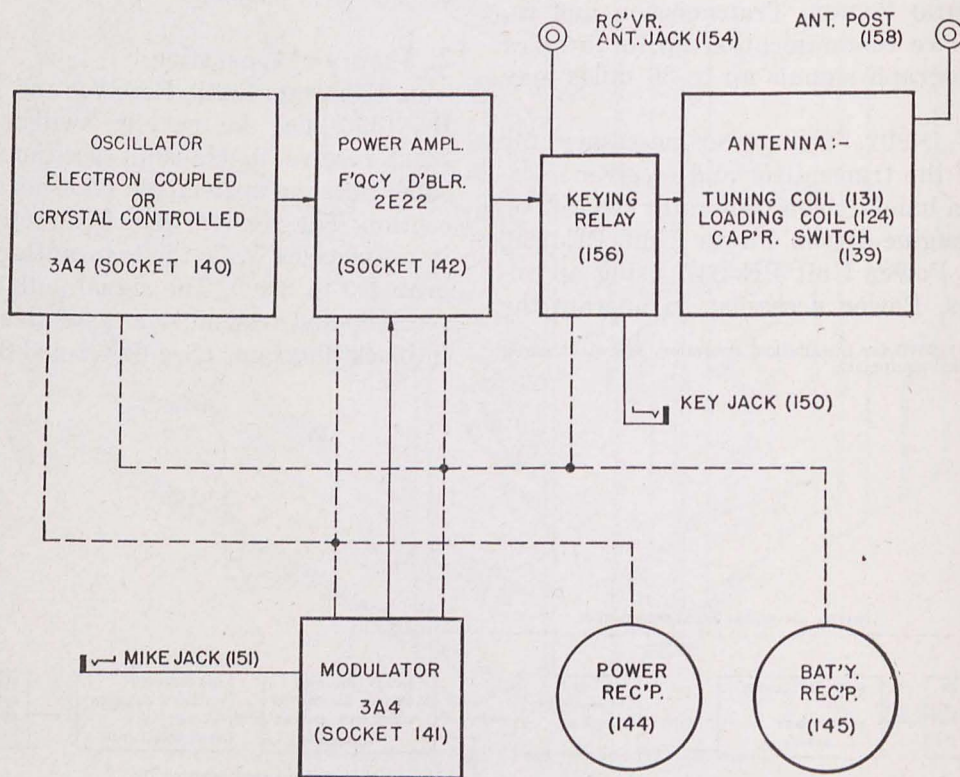

Figure 2. Block diagram, receiver of Radio Receiver and Transmitter BC-1306.

b. RECEIVER. The receiver section is a six-tube superheterodyne designed for the reception of c-w signals and for amplitude-voice modulated signals, in the band of 3.8 to 6.5 mc (megacycles). The received signal picked up by the antenna is coupled to the control grid of the r-f (radio-frequency) amplifier Tube JAN-1L4. The output of this tube is coupled to grid No. 6 of the mixer-oscillator Tube JAN-1R5 where it is mixed with the output of the h-f (high-frequency) oscillator circuit to produce an i-f (intermediate-frequency) of 456 kc. The h-f oscillator circuit also supplies bias voltage for the audio-output stage. The output of the mixer tube is coupled to the control grid of the first i-f amplifier Tube JAN-1L4. The amplified output of this stage is coupled to grid No. 6 of the second i-f amplifier Tube JAN-1R5. The i-f output of this stage is fed to the diode (second detector) section of Tube JAN-1S5. This stage develops the a-v-c (automatic-volume-control) voltage which is fed to the control grid of the first r-f amplifier and the first i-f ampli-

fier stages. A portion of the audio output of the diode is fed to the pentode (first audio-amplifier) section of Tube JAN-1S5 where it is amplified and then coupled to the audio-output amplifier Tube JAN-3Q4. The amplified output of this tube is coupled through an audio-output transformer to the output PHONE jacks.

The bfo (beat-frequency oscillator), section of Tube JAN-1S5 operates at one-half the intermediate-frequency. The oscillator output is coupled to grid No. 6 of the second i-f amplifier stage where its second harmonic is mixed with the i-f. The bfo is made inoperative when the PHONE-CW-NET-CAL switch is in the PHONE position. The 200 kc crystal oscillator is used for dial calibration purposes. It employs the cathode, first control grid, and the anode grid of Tube JAN-1R5. The r-f voltage developed across the crystal is coupled to the control grid of the r-f amplifier, Tube JAN-1L4. The calibrator oscillator is operative only when the PHONE-CW-NET-CAL is in the CAL position.



TL 70753

Figure 3. Block diagram, transmitter of Radio Receiver and Transmitter BC-1306.

c. TRANSMITTER. Fundamentally, the transmitter is a master oscillator power amplifier for c-w transmission and amplitude modulated by a modulator stage when MCW and PHONE operation is required. The oscillator stage, Tube JAN-3A4, generates a radio-frequency signal at a frequency either self-excited as a master oscillator, or crystal controlled. The plate circuit of the oscillator drives the grid circuit of the p-a (power amplifier) Tube JAN-2E22. This grid circuit is tuned to twice the oscillator frequency. The plate circuit of the p-a tube fur-

nishes r-f power output to a keying relay which when keyed, transfers the r-f to the antenna post via the antenna tuning network. When modulated types of transmissions are used, the modulator stage, Tube JAN-3A4, furnishes the necessary a-f (audio-frequency) power to modulate the suppressor grid of the power amplifier Tube JAN-2E22. During modulated-continuous-wave transmission, the modulator tube is converted to an audio oscillator. A sidetone circuit permits the operator to monitor his transmissions.

SECTION II

DIFFERENCES BETWEEN MODELS

(Not Applicable)

SECTION III

INITIAL REPAIR PROCEDURES

3. General

Note. Before making any repairs or adjustments, all Modification Work Orders should be applied. See WD Pamphlet 12-6 for list of applicable Modification Work Orders.

Maintenance personnel should follow the procedure outlined in this manual when repairing and servicing Radio Receiver and Transmitter BC-1306. The repair data in this and the following sections is presented in the order in which the repairman should actually perform

the various operations on the equipment in the repair shop. This procedure permits repair of the equipment in the shortest time possible, and results in performance comparable to that of new equipment.

4. Tools, Test and Cleaning Equipment

The equipment and materials shown in table II should be available for the proper servicing of Radio Receiver and Transmitter BC-1306.

Table II

Item	Description
1. Assorted tools.	<ul style="list-style-type: none"> a. Pliers: diagonal and long-nose. b. Screw drivers: several sizes. c. Soldering iron. d. Resin core solder. e. Wrenches: No. 4-5-6; spintite type. f. Flashlight or probing light. g. Dental mirror. h. Burnishing tool (for relay contacts).
2. Fiber alignment tools.	<ul style="list-style-type: none"> a. Screw drivers: insulated. b. Socket wrenches: with nonmetallic shafts.
3. Dummy antennas.	<ul style="list-style-type: none"> a. Receiver: <ul style="list-style-type: none"> One each 110-mm, 250-mm, and 0.01-mf capacitors. b. Transmitter: <ul style="list-style-type: none"> One 5,000-ohm 20-watt carbon or noninductive resistor. One r-f metering circuit TL-70774.
4. Test leads.	<ul style="list-style-type: none"> a. One pair with prods. b. One pair with clips.
5. Special cords.	<ul style="list-style-type: none"> a. CD-1119. b. CD-1086 (7 ft and 44 in.). c. CD-318-A. d. Circuit test cable (receiver).
6. Voltohmmeter.	Sensitivity of 1,000 ohms per volt with multiple ranges up to 750 volts; high, medium, and low resistance ranges.
7. Vacuum-tube voltmeter.	For measuring a-c and d-c voltages with multiple scales up to 500 volts.
8. Output meters.	<ul style="list-style-type: none"> a. Receiver: 4,000-ohm impedance, multiple voltage scales. b. Transmitter: 0- to 115-current squared galvanometer and 0- to 2-thermo-couple ammeter.
9. Frequency meter.	Calibrated, similar to Frequency Meter Set SCR-211, or equivalent.
10. R-f signal generator.	To cover ranges from 175 kc to 7,500 kc, capable of 30% modulation at 400 cps.
11. A-f oscillator.	Variable frequency range 30 to 15,000 cycles.
12. Cathode-ray oscilloscope.	3-in. tube (minimum).
13. Tube tester.	Either dynamic or emission type.
14. Headset.	HS-30- () with Cord CD-933.
15. Key.	J-45 or equivalent.
16. Microphone.	T-17, T-45, or equivalent.
17. Test plugs.	PL55 or equivalent.
	PL51 or equivalent.
18. Neon test lamp.	For checking presence of r-f.

Table II (Contd.)

Item	Description
19. Cleaning materials.	<ul style="list-style-type: none"> a. Solvent, dry-cleaning (SD). b. Petroleum spirits. c. Instrument oil. d. Clean cloth (nonlintable). e. Assorted brushes. f. Pipe cleaners. g. 4/0 sandpaper. h. Crocus cloth. i. French cloth. j. Compressed air or air dryer or blower.
20. Power sources.	<ul style="list-style-type: none"> a. Battery BA-48. b. Vibrator Power Unit PE-237. c. Generator GN-58.

5. Disassembly of Receiver for Cleaning, Inspecting, and Lubricating

a. PRELIMINARY. Release the two retainer

clamps on each side of case, and remove receiver from case by pulling forward. (See fig. 4.)

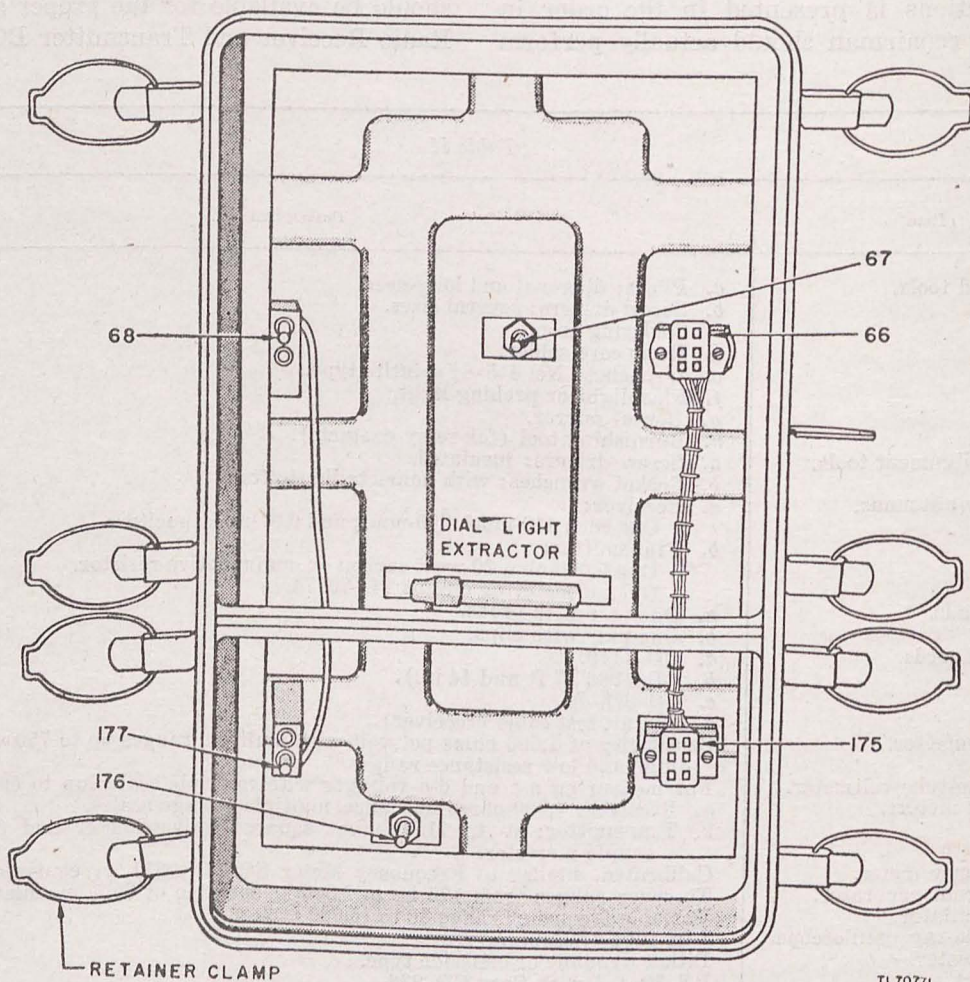

Figure 4. Case components of Radio Receiver and Transmitter BC-1306.

b. **TUBES.** Release the tube shield assembly by loosening snap fasteners located on each side, and lift the assembly out. Remove all tubes from sockets by lifting straight up.

c. **CRYSTAL.** The calibrating crystal holder (fig. 5), is accessible after removing the tube shield assembly. Remove the holder by pulling straight upward.

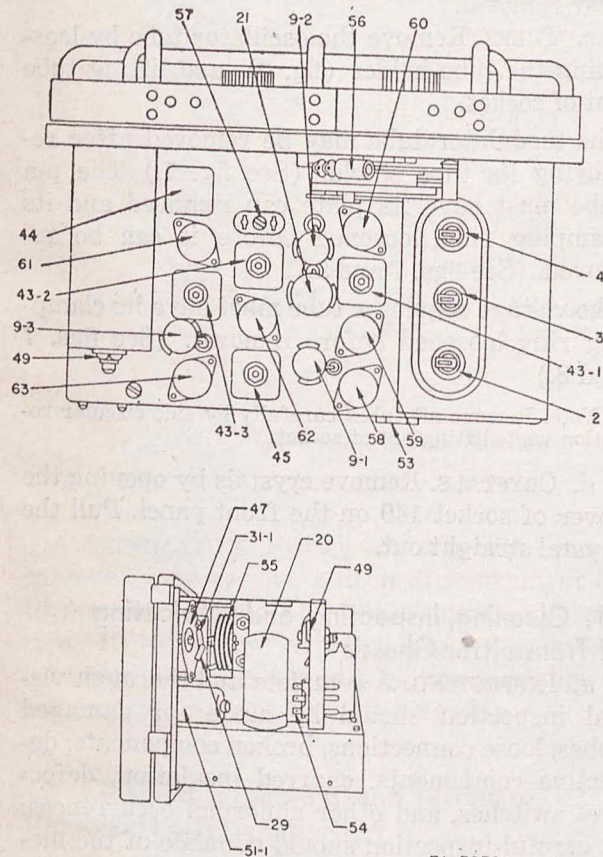

Figure 5. Parts identification, top and end view of receiver, Radio Receiver and Transmitter BC-1306.

d. **DIAL LIGHT.** Use the dial light extractor furnished with the set (the extractor is clamped to the interior of the case back of the receiver unit, and is readily accessible when the receiver is out of the case). (See fig. 4.) Push the dial light extractor over the bulb, turn bulb counter-clockwise and pull it out of socket.

e. **SHIELDING.** Remove screws and washers holding bottom plate to chassis and remove plate. Remove screws and washers holding ganged tuning capacitor shielding and remove shielding. Remove screws and washers holding shield of SENSITIVITY switch and remove shield. Remove nuts holding shield of PHONE-CW-NET-CAL switch and remove shield.

6. Cleaning, Inspecting, and Lubricating of Receiver Chassis

a. **CLEANING.** Thorough cleaning of the receiver is necessary to insure optimum performance and to prevent corrosion, rust, and dirt from damaging parts or causing arc-over or low-resistance leakage between high-voltage points and ground. Remove loose dust and dirt with a brush or blower. Remove dirt or grease which adheres to the chassis or parts with a brush or cloth and dry-cleaning solvent (SD). Remove dust or dirt between plates of the ganged tuning capacitors with a pipe cleaner and blower. Clean tuning capacitor bearings and rotor-grounding springs with dry-cleaning solvent (SD). Clean rusted or corroded spots on chassis with solvent, dry cleaning applied with cloth, or with fine sandpaper. Clean contact-making parts of sockets, power plug, antenna jack, ground jack, switches, and phone jacks with dry-cleaning solvent (SD), applied with a rag or pipe cleaner.

b. **INSPECTING.** After the chassis has been thoroughly and carefully cleaned, make a visual inspection of parts and wiring for loose connections, frayed or burned insulation, loose screws, and burned or charred resistors and coils. Make a careful inspection of tube sockets for broken contacts, and switches for loose or bent contacts or broken insulation. Inspect all tuning-dial gears, and setscrews. Inspect parts made of porcelain, glass, or moulded material for chips or cracks. Inspect all mechanical movable parts for smooth working action, and all switches for good contact.

c. **LUBRICATING.** The receiver tuning-dial bearings and gears are lubricated at the time of manufacture with sufficient lubricant to last the life of the equipment under normal conditions. However, if lubrication becomes necessary after cleaning or because of abnormal use, apply a drop of instrument oil, by means of a toothpick, to the shaft bearings of the ganged tuning capacitor, SENSITIVITY switch, PHONE-CW-NET-CAL switch and VOLUME control.

7. Cleaning, Inspecting, and Testing of Removed Parts (Receiver)

a. **TUBES.** Clean pins of each tube with dry-cleaning solvent (SD) applied with brush and, for heavier corrosion, use crocus cloth applied with care. Inspect tube for bent pins, also internal and external breaks. Shake the tube to

detect loose pins and elements. Check tube in tube tester, allowing sufficient time for tube to heat up. Tap tube gently during test for loose or defective elements. Check for shorts between elements.

b. DIAL LIGHT. Clean contacts of dial light bulb with dry-cleaning solvent (SD), and for heavier corrosion use crocus cloth applied with care.

c. CRYSTAL HOLDER. Clean prongs of crystal holder with dry-cleaning solvent (SD), and for heavier corrosion use crocus cloth applied with care.

d. SHIELDS. Remove dust, rust, and corrosion; oil and grease, from shields with dry-cleaning solvent (SD), and careful use of crocus cloth.

8. Repair or Replacement of Defective Parts (Receiver)

Before replacing any part which on inspection indicated improper electrical operation, or signs of overload, such as charring and burning, make a thorough check of the circuit to discover the cause. Check voltages and resistances, as outlined in section VIII, and correct trouble before replacing defective parts. Replace all wires having broken or poor connections. Replace all defective screws, bolts, and nuts.

9. Reassembly of Removed Parts (Receiver)

After making the foregoing initial inspection and replacement of the parts visibly defective, replace the parts previously removed, but do not replace bottom plate at this time. Consult the tube lay-out diagram (on the end of the receiver chassis) for proper socket corresponding to each tube type. Before attempting to insert a tube in its socket, line up the blank space on the socket with the corresponding space on the tube base. Insert all tubes and the crystal. Push the tube shield down over the tubes until the catches snap in place. Replace the dial light bulb with the fingers, simultaneously pushing the bulb downward and twisting clockwise. Do not replace receiver in case at this time.

10. Disassembly of Transmitter for Cleaning, Inspecting, and Lubricating

a. PRELIMINARY. Remove the transmitter from case by releasing the two retainer clamps on each side of case. (See fig. 1.) Securely grip the panel guard and pull the unit straight out. Firm seating of the rubber seal may cause the

unit to adhere to the case. *Be careful not to break the Tube JAN-2E22 (left rear of chassis), or damage the rubber seal around the rear of the front panel.*

b. NEON BULB. Remove polaroid indicator cover by turning the rear knurled rim counterclockwise and unscrewing. Remove neon bulb by pressing in gently and twisting slightly to the right. The bulb has a bayonet type base for easy removal.

c. TUBES. Remove the oscillator tube by loosening the tube holder (fig. 6), and lifting tube out of socket.

The modulator tube may be removed after removing its tube shield. (See fig. 7.) The p-a tube must have its plate cap removed and its clamping ring loosened before it can be removed. (See figs. 7 and 8.)

The voltage regulator tube must have its clamping ring loosened before removal. (See figs. 7 and 8.)

Note. Remove all tubes carefully by side circular rotation while lifting out of socket.

d. CRYSTALS. Remove crystals by opening the cover of socket 149 on the front panel. Pull the crystal straight out.

11. Cleaning, Inspecting, and Lubricating of Transmitter Chassis

a. INSPECTING. A complete and thorough visual inspection should be made for damaged tubes, loose connections, broken components, defective components, charred insulation, defective switches, and other abnormal occurrences. A careful inspection should be made of the mechanical condition of all component parts. Examine tube sockets for broken contacts, switches for faulty contacts or broken parts, loose screws, unsoldered connections, or broken wires.

b. CLEANING. Collections of dust, rust, or corrosion may cause leakage between high-voltage points and ground, and impair operation. Remove loose dust with a brush or blower. Heavy dirt or grease collections adhering to the chassis or other parts should be removed with a brush or cloth and dry-cleaning solvent (SD). Rusted or corroded spots should be removed with fine sandpaper and dry-cleaning solvent (SD), if necessary. Contact-making parts of sockets, plugs, jacks, and switches should be cleaned, where necessary, by an application of dry-cleaning solvent (SD).

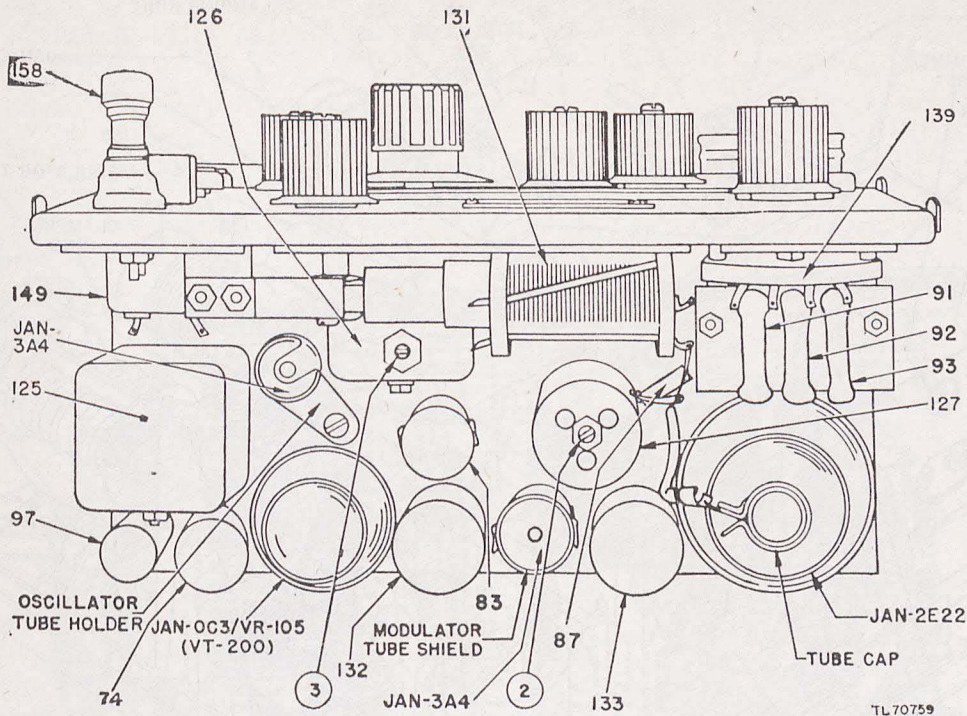

Figure 6. Parts identification of transmitter, top view, of Radio Receiver and Transmitter BC-1306.

c. LUBRICATING. Switch contacts that are not corroded may receive a drop of instrument oil to prevent sticking and allow smoother operation. If necessary, apply a slight amount of lubricant to the rack and pinion assembly of antenna tuning coil 131. (See fig. 8.)

12. Cleaning, Inspecting, and Testing of Removed Parts (Transmitter)

a. GENERAL. All removed parts should be properly serviced before replacement. Component parts are to be tested for short circuits, open circuits, and grounds. All parts must conform to proper values as listed in section VIII, and replacement parts must meet these values before installation. Switch contacts, tube socket contacts, and plug prongs should be cleaned only when necessary to remove corrosion. *Do not remove silver plating from any contacts and NEVER use emery cloth.*

b. TUBES. Examine all tubes for corroded prongs, bent pins, cracked glass, loose elements, or other abnormalities. Test tubes in tube tester, if available, and replace where necessary. Clean all tube prongs with application of dry-cleaning solvent (SD), and for heavier corrosion use

crocus cloth applied with care. This applies also to the contacts of neon bulb in socket 152.

c. CRYSTAL HOLDERS. Discoloring or corrosion on pins may be removed with an eraser. If crocus cloth is used, *do not* remove silver plating.

d. COVER SHIELD OF GANGED TUNING CAPACITOR. Rust, corrosion, oil or grease collections should be removed by scraping or brushing and dry-cleaning solvent (SD).

13. Repair or Replacement of Defective Parts (Transmitter)

Before replacing any part which showed signs of overload, or upon inspection indicating improper electrical operation, a thorough check of the circuit should be made to discover the cause. For voltage checks see figure 9, and for resistance checks see figure 10 and data contained in section VIII, and correct trouble before replacing defective parts.

Renew all wiring where necessary and resolder any defective connections. Replacement values of defective parts may be secured by referring to section VIII.

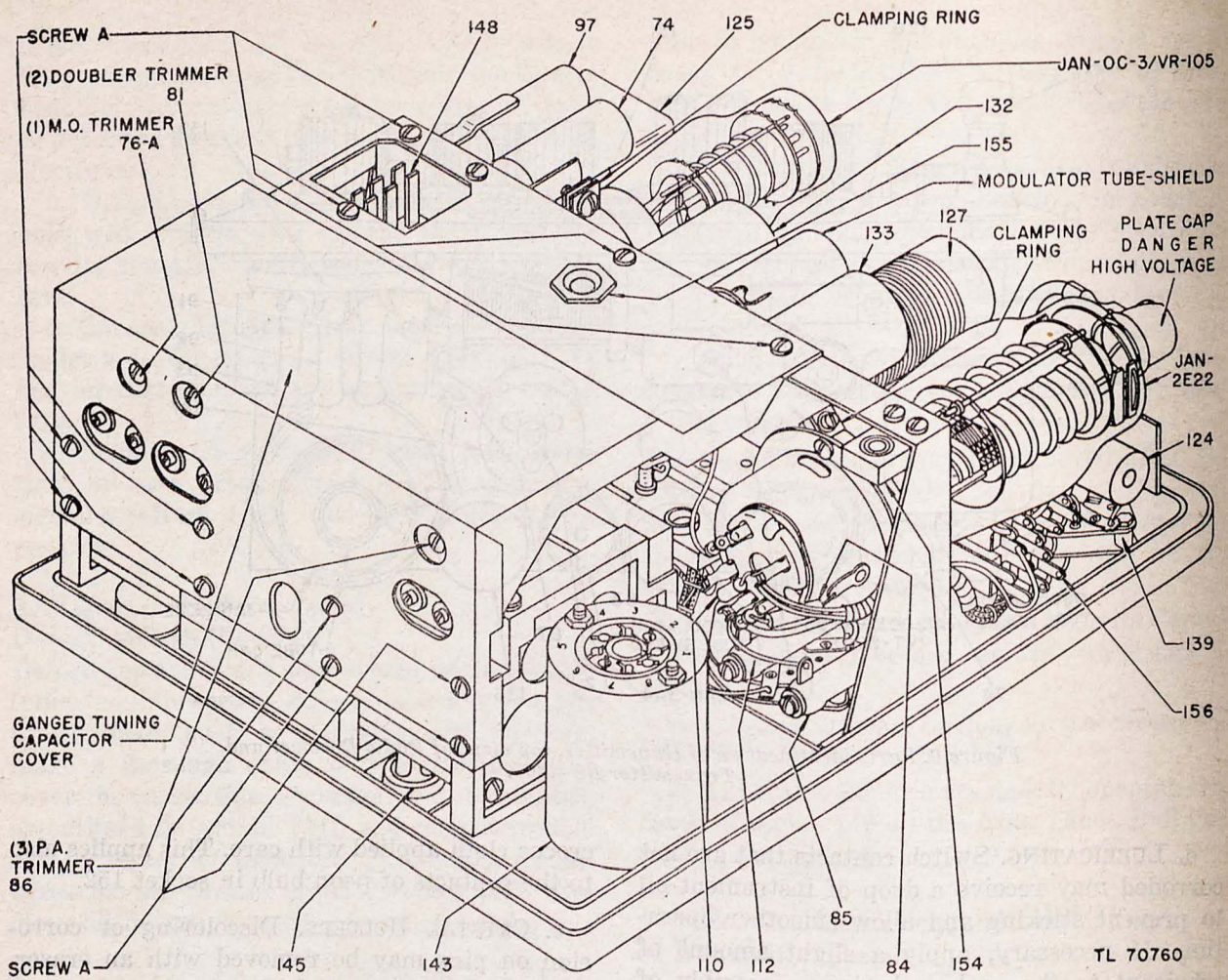

Figure 7. Parts identification, rear view, of transmitter of Radio Receiver and Transmitter BC-1306.

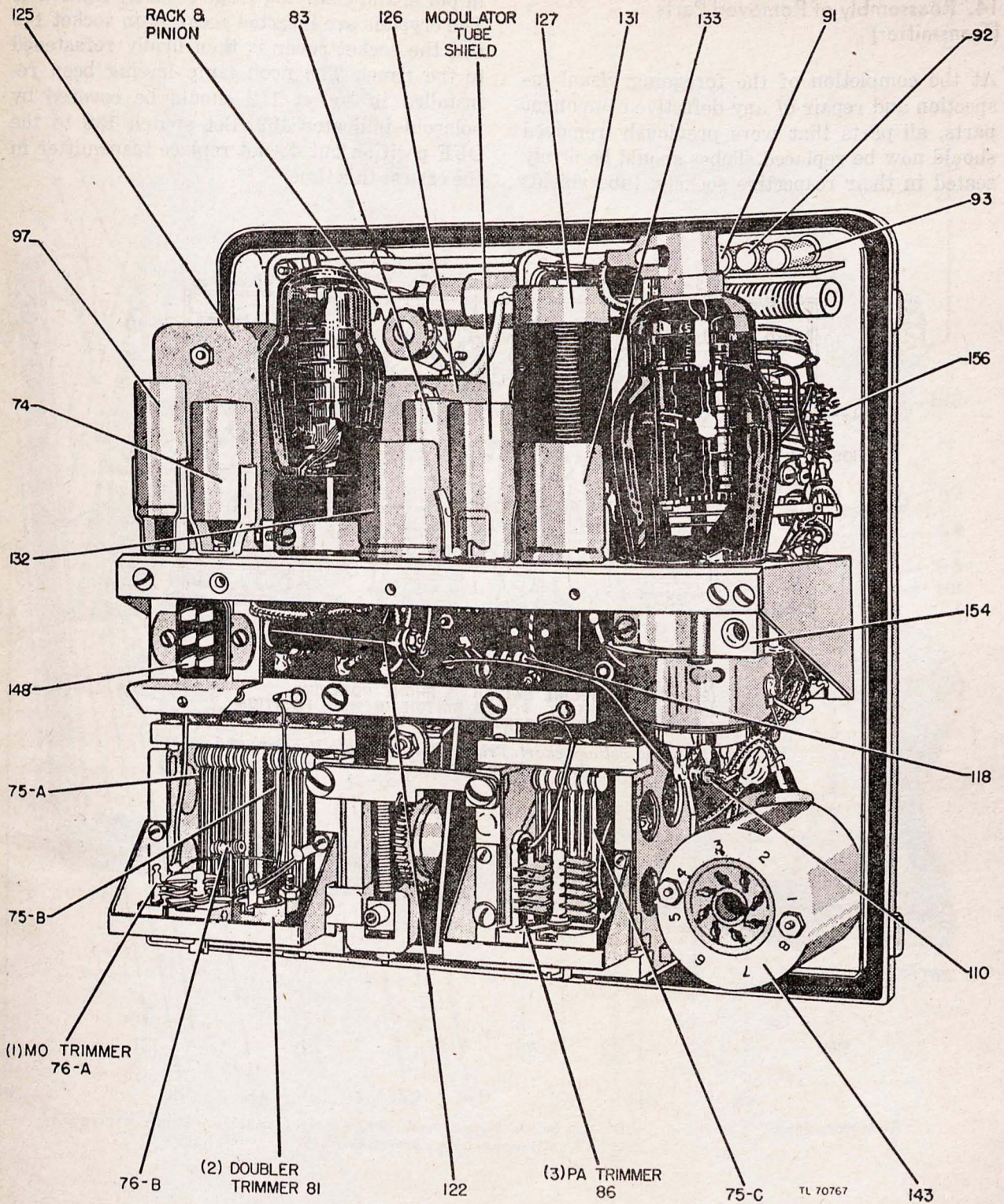

Figure 8. Transmitter of Radio Receiver and Transmitter BC-1306, rear view, cover removed from ganged tuning capacitor.

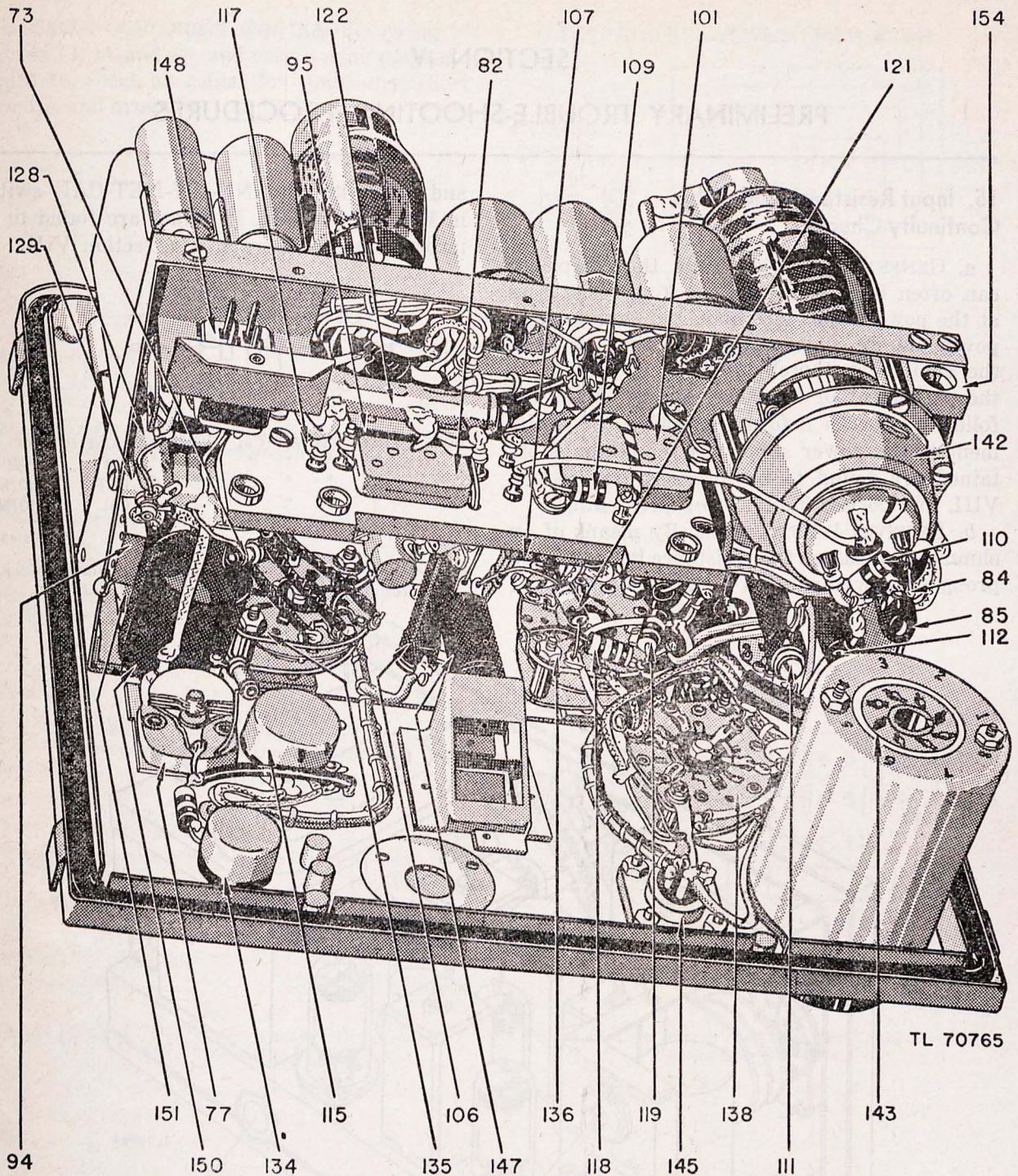

Figure 10. Parts identification, rear view, less ganged tuning capacitor and cover, for Transmitter of Radio Receiver and Transmitter BC-1306.

SECTION IV

PRELIMINARY TROUBLE-SHOOTING PROCEDURES

15. Input Resistance and Cable Continuity Checks

a. GENERAL. Trouble within the equipment can often be detected by checking resistances at the power input terminals and continuity of power supply cables before applying power to the equipment, thereby preventing damage to the equipment or its power supply. Make the following checks before connecting the equipment to the power supply. If the readings obtained are found to be incorrect, see section VIII, and correct fault before proceeding.

b. RECEIVER INPUT CHECK. By means of an ohmmeter, measure the resistance between each prong of power plug 54 and chassis (figs. 11

and 12) with PHONE-CW-NET-CAL switch in PHONE position. If values are found to be incorrect see paragraph 34a, section VIII.

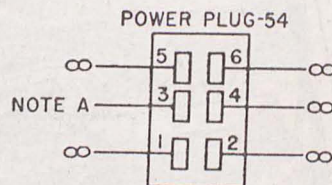

NOTE A	PHONE	CW	NET	CAL	SWITCH IN	PHONE POS.	-	∞
"	"	"	"	"	"	"	"	∞
"	"	"	"	"	"	"	"	-107MΩ
"	"	"	"	"	"	"	"	-107MΩ

TL51451-S

Figure 11. Power plug input resistances for receiver of Radio Receiver and Transmitter BC-1306.

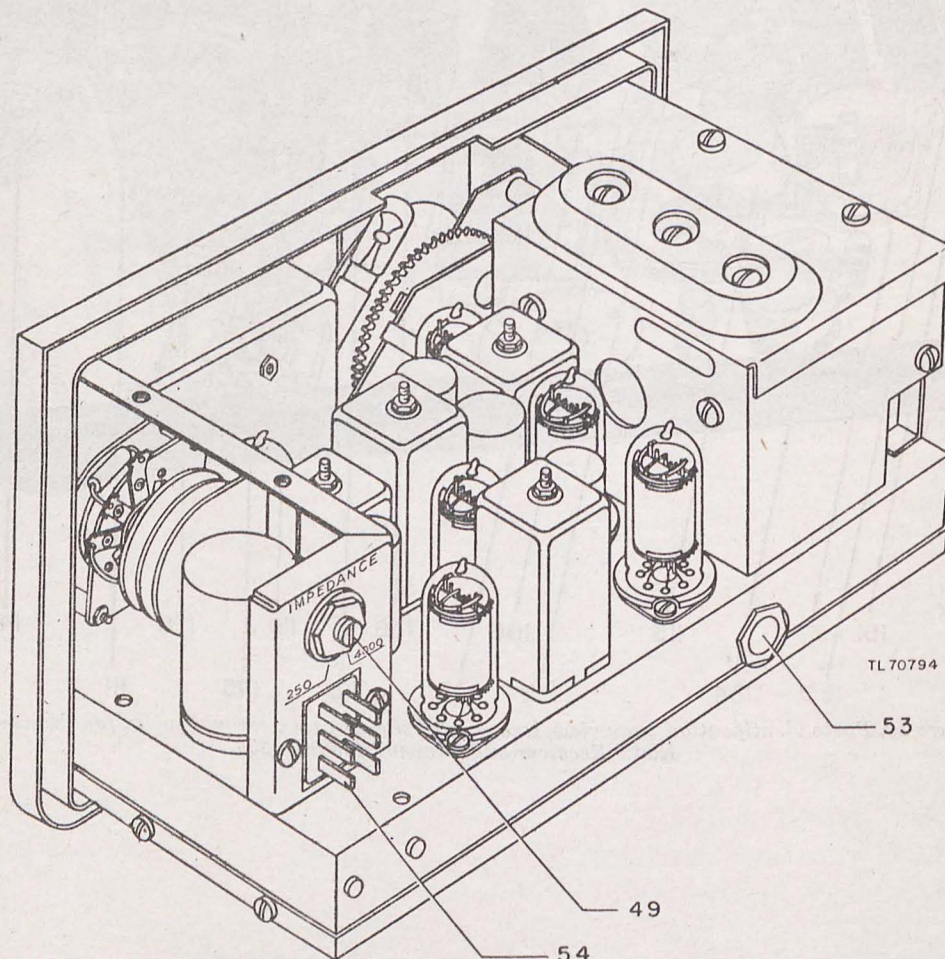

Figure 12. Parts identification for receiver, rear view, of Radio Receiver and Transmitter BC-1306.

c. CABLE CONTINUITY CHECKS. Referring to figures 13, 14 and 15, and case wiring diagram, figure 16, check all cables for continuity, short circuits, and grounds.

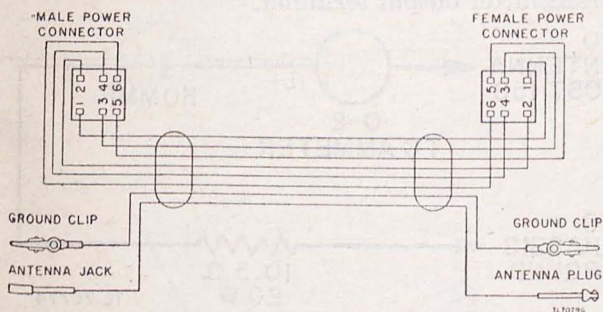

Figure 13. Circuit test table for receiver, of Radio Receiver and Transmitter BC-1306.

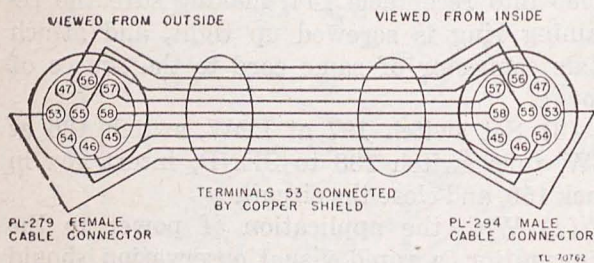

Figure 14. Cord CD-1086, for transmitter, of Radio Receiver and Transmitter BC-1306.

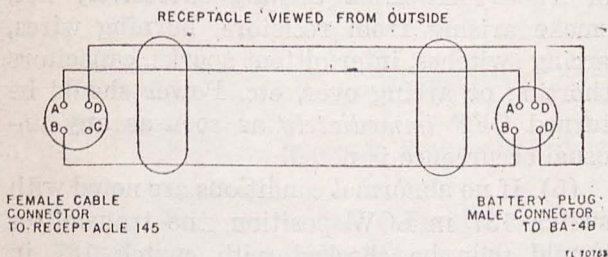

Figure 15. Cord CD-1119 for transmitter, of Radio Receiver and Transmitter BC-1306.

RECEPTACLES VIEWED FROM REAR

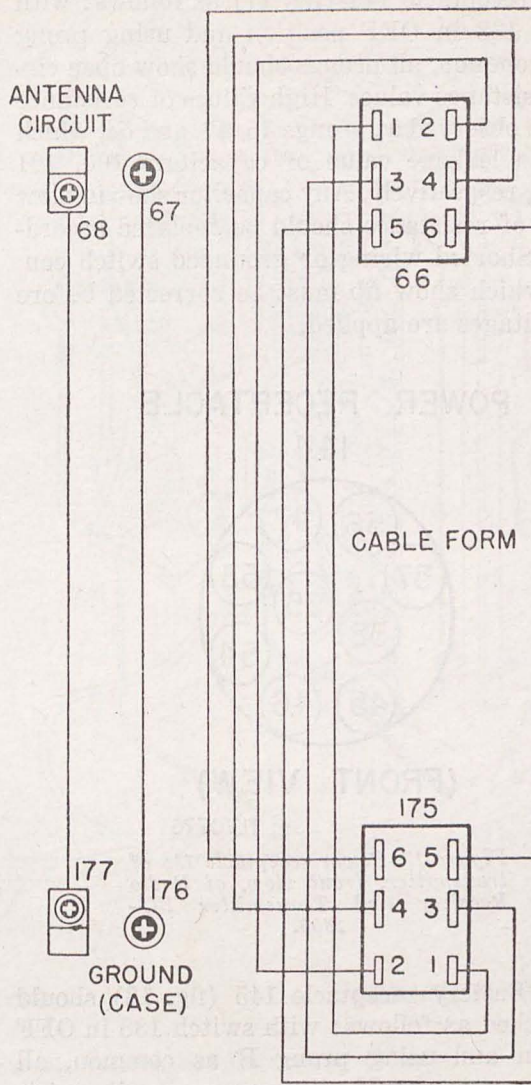

Figure 16. Case wiring diagram, Radio Receiver and Transmitter BC-1306.

TL70772

d. TRANSMITTER INPUT CHECKS. (1) Check power receptacle 144 (fig. 17) as follows: with switch 138 in OFF position and using prong 53 as common, all prongs should show open circuit resistance values. High values of resistance may be observed at prongs 45, 47, and 54, which indicate leakage value of capacitors 100, 101 and 99, respectively. Any capacitor showing low values of resistance should be replaced accordingly. Shorted wiring or grounded switch contacts which show up must be corrected before any voltages are applied.

POWER RECEPTACLE

144

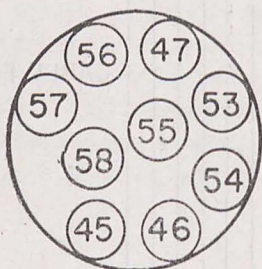

(FRONT VIEW)

TL70776

Figure 17. Power receptacle 144 of transmitter, front view, of Radio Receiver and Transmitter BC-1306.

(2) Battery receptacle 145 (fig. 18) should be checked as follows: with switch 138 in OFF position and using prong B as common, all other prongs should show open circuit resistance readings for normal circuit operation. Grounded switch contacts or shorted wiring must be repaired before battery supply is connected.

BATTERY RECEPTACLE

145

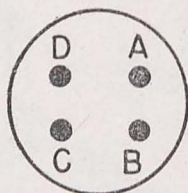

(FRONT VIEW)

TL70778

Figure 18. Battery receptacle 145 of transmitter, front view, of Radio Receiver and Transmitter BC-1306.

16. Operational Tests

a. TRANSMITTER. It is imperative that the transmitter unit must be loaded at all times before power is applied.

(1) Connect dummy load (fig. 19) across transmitter output terminal.

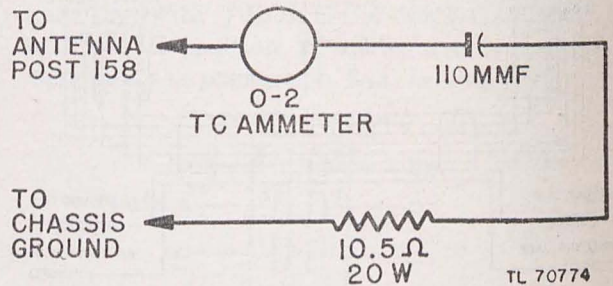

Figure 19. Dummy load r-f metering circuit for transmitter of Radio Receiver and Transmitter BC-1306.

(2) Plug the female connector of Cord CD-1086 into receptacle 144, making sure the retaining ring is screwed up tight, and attach male connector of same cord to the source of power.

(3) Set switch 137 at LOW, switch 136 at CW, turn switch 138 to SEND, insert key in jack 150, and close the circuit.

(4) With the application of power to the transmitter, a rapid visual observation should be made for evidence of overheating or any other unusual occurrences. Watch for the plate of Tube JAN-2E22 turning excessively hot, smoke arising from resistors, burning wires, arcing switches, intermittent sparks, capacitors shorting or arcing over, etc. Power should be turned OFF *immediately* as soon as any unusual occurrence is noted.

(5) If no abnormal conditions are noted with switch 137 in LOW position, the transmitter should then be checked with switch 137 in MED. and HIGH positions. Reference should be made to section VIII, and any abnormalities corrected before tests are made.

(6) Turn power OFF, disconnect Cord CD-1086 from receptacle 144.

(7) Replace transmitter in the case, being careful not to damage Tube JAN-2E22 and enter all plug-in connections properly without forcing. Secure all four retainer rings holding transmitter in case.

b. RECEIVER. Referring to figure 20, connect the female end of the circuit test cable to plug 54 on rear of receiver and connect the other end of the cable to receptacle 175 on the case. Fasten alligator grounding clips on both ends of cable to chassis and case.

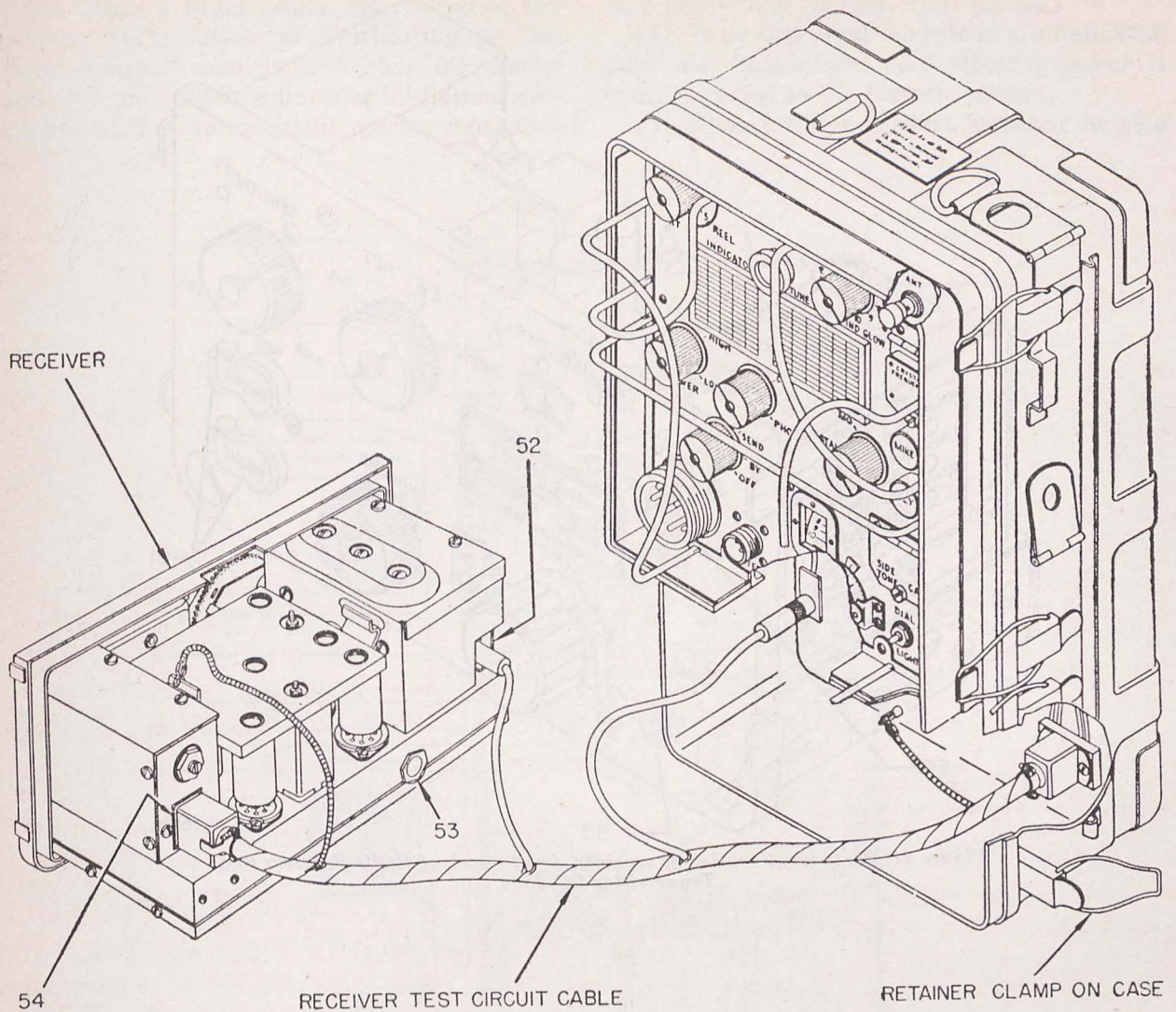

TL 70795

Figure 20. Receiver test set-up for Radio Receiver and Transmitter BC-1306.

(1) Plug the female connector of Cord CD-1086 into receptacle 144 on the transmitter making sure the retaining ring is screwed up tightly. Attach male connector at the other end of cord to a source of power.

(2) Plug a pair of earphones into one of the PHONE jacks of the receiver. (See fig. 21.) Turn switch 138 on the transmitter panel to STANDBY, thus applying power to the receiver.

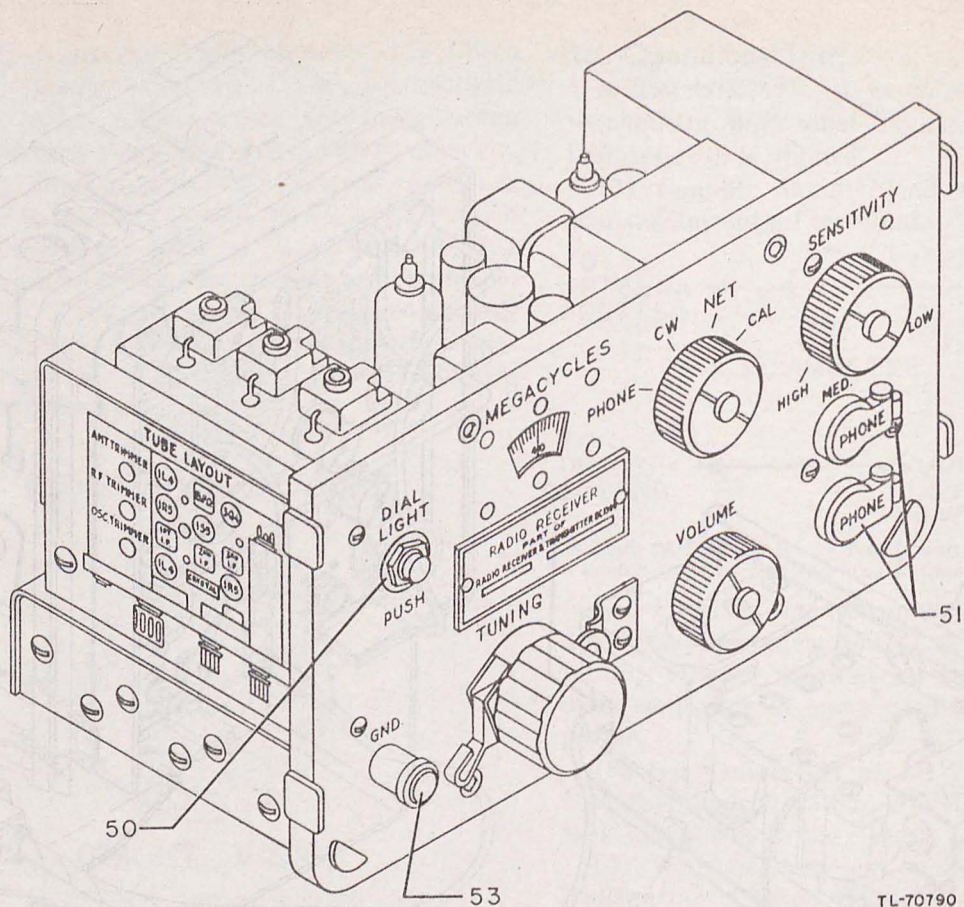

Figure 21. Parts identification of receiver, front panel, of Radio Receiver and Transmitter BC-1306.

TL-70790

(3) Make a rapid visual observation of the receiver for evidence of overheating or any other unusual conditions. Watch for smoke arising from resistors, burning insulation, arcing at switches, intermittent sparks, capacitors

fore proceeding further. (See fig. 22.)

(4) If no abnormal conditions are indicated, push dial button and note whether power is being supplied to the filament circuit.

(5) Repeat the procedure outlined in step

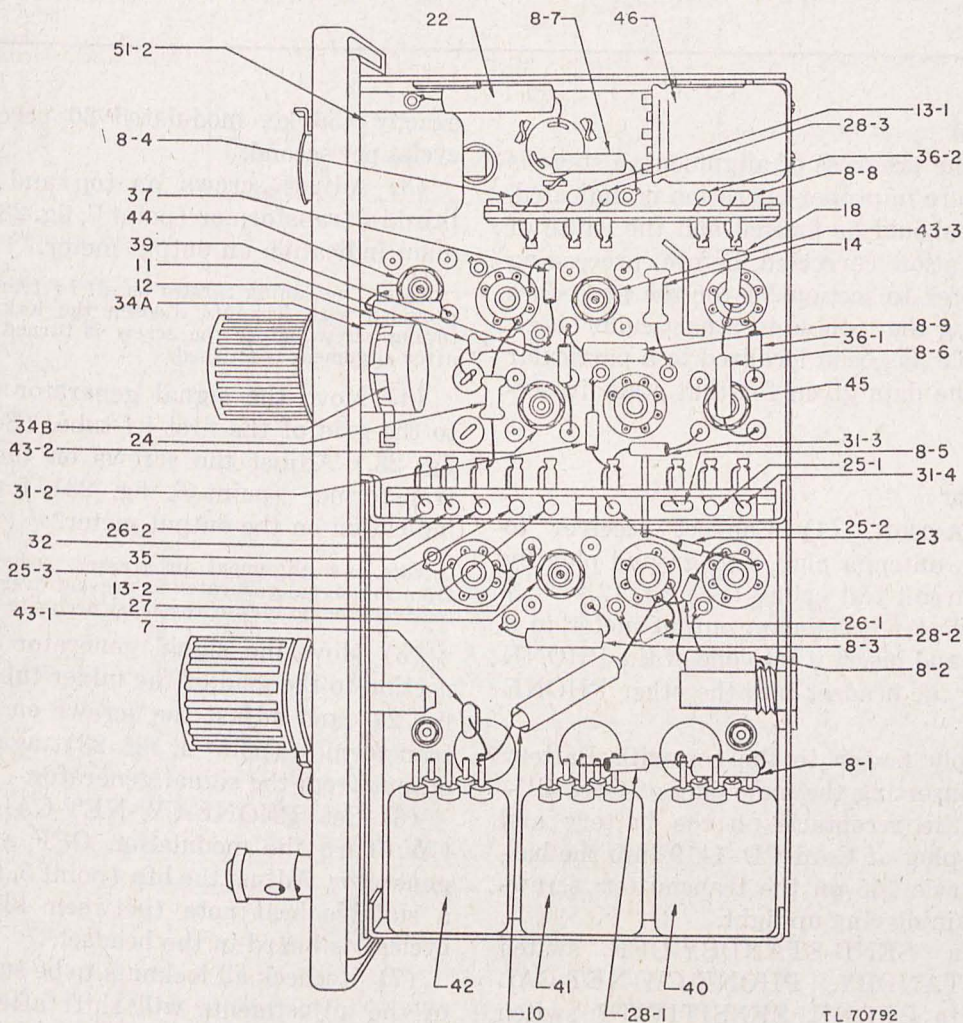

TL 70792

Figure 22. Parts identification of receiver, bottom view, of Radio Receiver and Transmitter BC-1306.

shorting or arcing over. Power should be turned OFF *immediately* if any abnormal conditions are indicated. Reference should be made to section VIII, and any abnormalities corrected be-

(4) above, for all positions of SENSITIVITY and PHONE-CW-NET-CAL switches.

(6) Turn switch 138 to OFF position.

SECTION V

ALIGNMENT PROCEDURE

17. General

If, during the progress of alignment, a stage is reached where improper operation is indicated, the trouble should be located and the cause of faulty operation corrected before proceeding further. Refer to section VI for the procedure for localizing the trouble to a particular stage. After trouble has been localized to a particular stage, see the data given for that stage in section VIII.

18. Receiver

a. PREPARATION. (1) Connect receiver to power plug, antenna plug, and ground plug by means of circuit test cable. (See fig. 13.)

(2) Connect a 4,000-ohm output meter to a phone plug and insert it into one of the PHONE jacks; plug the headset into the other PHONE jack.

(3) Supply power to the set with Battery BA-48 by inserting the male plug of Cord CD-1119 into the receptacle on the battery and the female plug of Cord CD-1119 into the battery receptacle 145 on the transmitter, screwing the retaining ring up tight.

(4) Turn SEND-STANDBY-OFF switch 138 to STANDBY, PHONE-CW-NET-CAL switch 48 to PHONE, SENSITIVITY switch 47 to HIGH, the VOLUME control to maximum clockwise position, and the IMPEDANCE switch on the back of the receiver (fig. 12) to 4000.

(5) Set the receiver on one end so that aligning screws on both top and bottom of chassis can be easily reached. *Do not remove the tube shield.*

b. PROCEDURE. (1) Connect the r-f (hot) terminal of the signal generator to the grid (terminal 6) of the second i-f tube (point 9, fig. 23) in series with a .01 mf dummy antenna capacitor.

(2) Turn on the signal generator and set to

exactly 456 kc, modulated 30 percent at 400 cycles per second.

(3) Adjust screws on top and bottom of third i-f transformer (point 7, fig. 23) for maximum indication on output meter.

Note. The tuning screws on all i-f transformers are provided with locknuts. Loosen the locknuts on each tuning screw before the screw is turned, and tighten after alignment is finished.

(4) Move the signal generator output lead to the grid of the first i-f tube. (See point 10, fig. 23.) Adjust the screws on the second i-f transformer (point 6, fig. 23) for maximum indication on the output meter.

Note. As alignment progresses, reduce the output from the signal generator to prevent overloading of the receiver and to obtain the most accurate alignment.

(5) Move the signal generator output connection to the grid of the mixer tube (point 11, fig. 23) and adjust the screws on the first i-f transformer (point 4, fig. 23), again reducing output from the signal generator.

(6) Set PHONE-CW-NET-CAL switch to CW. Turn the modulation OFF at the signal generator. Adjust the bfo (point 5, fig. 23) until a suitable beat note (between 400 and 1,000 cycles) is heard in the headset.

(7) Recheck all locknuts to be sure that none of the adjustments will shift after the set is restored to service. Disconnect the signal generator from the receiver.

(8) Set the PHONE-CW-NET-CAL switch to CAL. Adjust the receiver dial to 6.2 mc. (For examples of dial readings, see fig. 24.) If zero beat is not obtained with dial set at exactly 6.2 mc, vary its setting slightly above and below this point until zero beat is obtained with the crystal calibrator harmonic nearest the 6.2 mc dial markings.

(9) Leaving the position of the TUNING knob unchanged, set the PHONE-CW-NET-CAL switch to PHONE and connect the r-f lead of the signal generator to the antenna con-

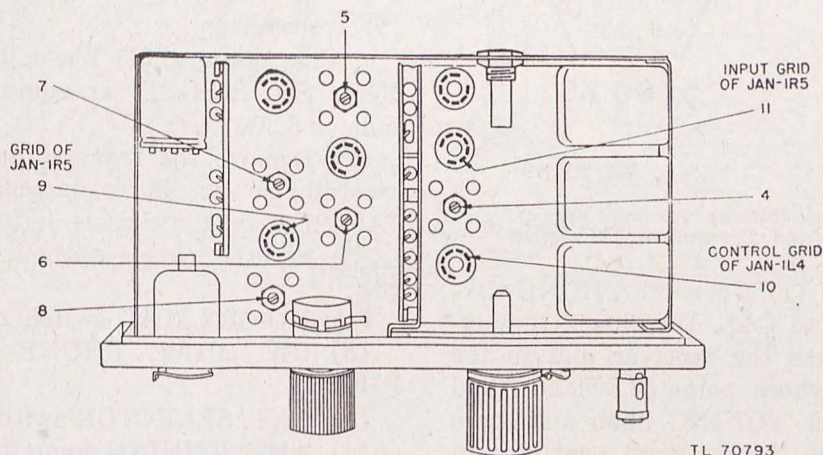
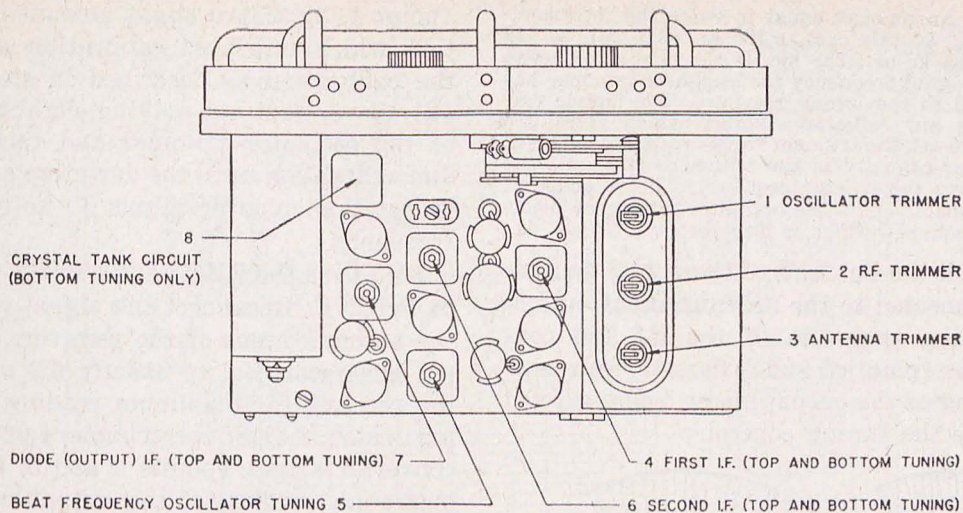

TL 70793

Figure 23. Alignment points for receiver of Radio Receiver and Transmitter BC-1306.

nection of the receiver in series with a 250 mmf dummy antenna capacitor.

(10) Set the signal generator dial to 6.2 mc with 30 percent, 400 cycles modulation. Vary the setting of the signal generator's dial slightly above and below this point until maximum indication of the receiver output meter is obtained. The signal generator's frequency is now exactly 6.2 mc and its dial setting should not be changed throughout the remainder of the receiver alignment.

(11) If the signal is received at the correct receiver dial reading, the oscillator is properly aligned. If the receiver dial does not indicate

exactly 6.2 mc, the oscillator must be realigned. Set the receiver dial to exactly 6.2 mc and adjust the oscillator trimmer (point 1, fig. 23) for maximum indication on the output meter.

Note. Some receivers will give a response at two adjustments of this trimmer. When adjusting an oscillator whose trimmer gives two responses, it is always wise to shift the signal generator frequency to the image frequency, to assure that the image frequency is above the signal frequency. If the signal frequency is 6.2 mc, the image should be heard when the generator is tuned to 6.2 mc plus twice the intermediate frequency (6,200 kc plus 912 kc equals 7.112 mc). The output of the signal generator usually must be increased considerably to hear the response at the image frequency. If no signal is heard at the place where the image signal is supposed to be received, tune the generator to the low side of the signal frequency and search for a response at a frequency lower than the signal

frequency by an amount equal to twice the intermediate frequency. In this case, 6,200 kc (6.2 mc) — 912 kc equals 5,288 kc or 5.288 mc. If the image frequency is below the signal frequency the oscillator trimmer has been adjusted to the wrong response. The simple rule for adjusting an oscillator trimmer which gives two responses is to set the trimmer to the response obtained with the lesser capacity in the trimmer. This puts the oscillator above the signal frequency. The response at the higher capacity puts the oscillator frequency below the signal frequency which is incorrect.

(12) With the hot lead of the signal generator still connected to the antenna input, adjust the remaining trimmers of the r-f and converter stages (points 2 and 3, fig. 23), for maximum reading of the output meter, being careful not to move the tuning control.

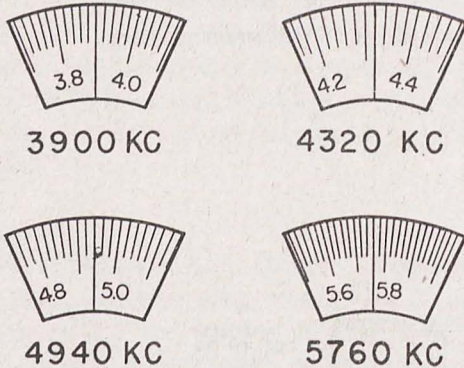

TL 70799

Figure 24. Dial settings for receiver of Radio Receiver and Transmitter BC-1306.

c. CALIBRATION. (1) Turn the PHONE-CW-NET-CAL switch to CAL. Disconnect the signal generator. Turn the receiver dial to the lowest frequency check point (3,800 kc), and adjust the receiver TUNING knob until zero beat is obtained on the strongest beat note in the vicinity of the crystal check point. Turn the SENSITIVITY switch to the lowest setting that will give satisfactory crystal check points. This avoids weak spurious signals that are not the correct calibration check points. The receiver is out of calibration by the amount that the index line on the dial window fails to coincide with the exact frequency. Note whether or not the deviation is less than plus or minus 30 kc.

(2) Having checked the calibration at 3,800 kc, proceed similarly through the entire tuning range checking the calibration at 4,000 kc, 4,200 kc, 4,400 kc, etc., up to 6,400 kc.

(3) If at any point on the dial the calibration of the receiver is off by more than plus or minus 30 kc, adjust the oscillator trimmer

(point 1, fig. 23) a slight amount in the direction which improves calibration and recheck the calibration as described in steps (1) and (2) above. Continue making slight adjustments of the oscillator trimmer and rechecking the dial calibration until the deviation at each point is less than plus or minus 30 kc of the exact frequency.

(4) Turn the PHONE-CW-NET-CAL switch to PHONE. Reconnect the signal generator to the antenna input of the receiver. Set the signal generator dial to exactly 6.2 mc and tune the receiver for maximum reading of the output meter. Adjust the trimmers of the r-f and converter stages (points 2 and 3, fig. 23), for maximum reading of the output meter, being careful not to move the TUNING control.

(5) Turn SEND-STANDBY-OFF switch on the transmitter to OFF. Disconnect Cord CD-1119 and the circuit test cable. Turn off and disconnect the signal generator.

19. Transmitter

a. PREPARATION. (1) Warm up the Frequency Meter Set, SCR-211 or equivalent, and tune same to 6,300 kc.

(2) Remove the transmitter from the case carefully so as not to damage the p-a Tube JAN-2E22 on the chassis, left side rear.

(3) Set the panel controls as follows (fig. 25):

(a) MO-CRYSTAL switch 135 at MO.

(b) CW - MCW - PHONE switch 136 at PHONE.

(c) ANT. SELECTOR switch 139 at 1.

(d) ANT. TUNING knob 131 at any position above 5. Loose coupling is desired, therefore, do not use any position below 5 as improper alignment may result.

(e) Set FREQ. CONTROL knob to 6,300 kc. (See fig. 26 for method of reading dial.)

(4) The antenna circuit MUST be loaded with a dummy load during this test (fig. 19), consisting of a 10.5-ohm, 20-watt carbon or noninductive resistor in series with a 110-mmf capacitor and a 0-2. r-f ammeter.

(5) The Power Cable CD-1086 and Battery Cable CD-1119 should now be securely locked into power receptacle 144 and battery receptacle 145 respectively.

(6) Turn power on.

(7) Insert the KEY cord plug into jack 150. Close KEY circuit and listen in on headphones

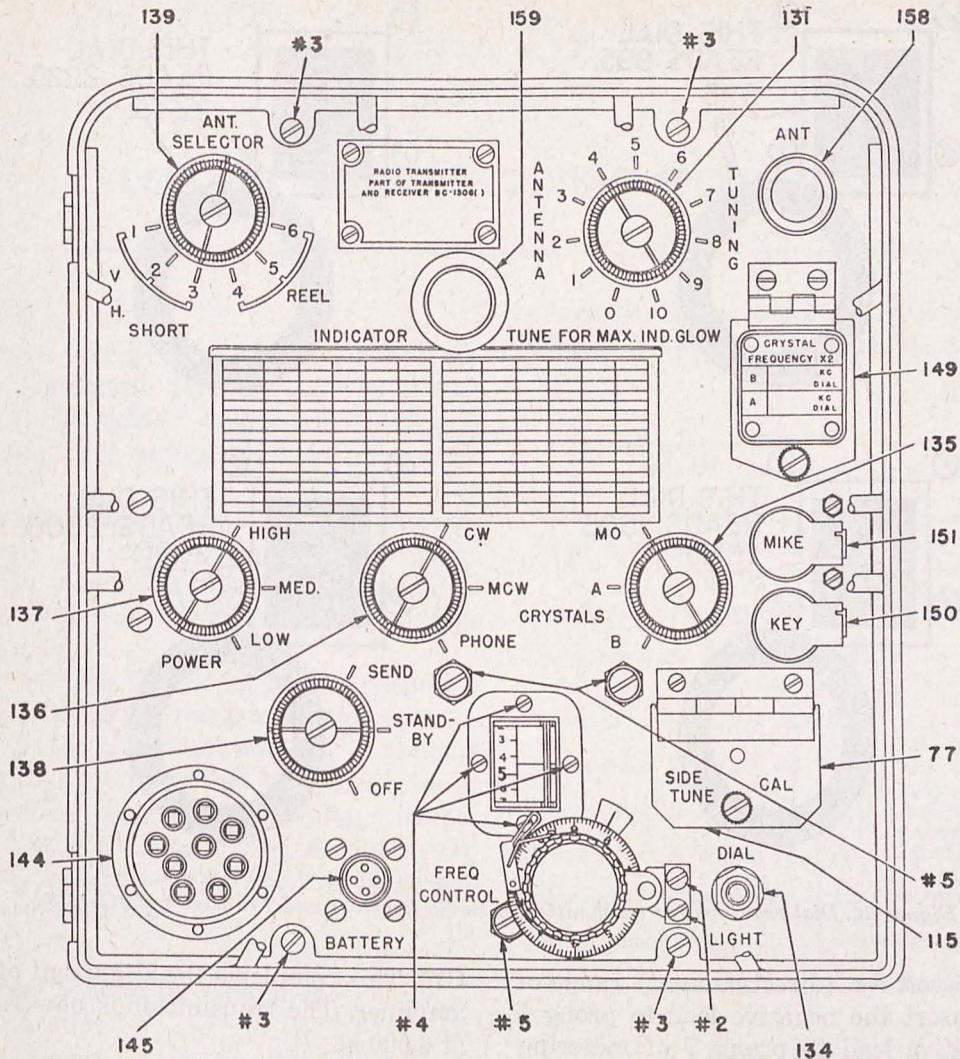

- (2) # 2 FREQ. CONTROL DIAL
CLAMPING RING SCREWS
- (4) # 3 PANEL GUARD MTG. SCREWS
- (4) # 4 DIAL WINDOW SCREWS
- (3) # 5 CAPACITOR MTG. SCREWS

TL 70761

Figure 25. Component parts on front panel of transmitter of Radio Receiver and Transmitter BC-1306.

of the frequency meter for a signal from the transmitter.

b. PROCEDURE. (1) *Oscillator tuning.* Capacitor 76-A is a trimmer across capacitor 75-A, the oscillator section of ganged tuning capacitor assembly. Using an insulated screw driver, carefully adjust this MO trimmer (item 1, fig. 7) to exact zero beat of 6,300 kc. A beat note or signal will be heard before and after the zero beat, while rotating this trimmer capacitor. The

spot of no signal or zero beat indicates the alignment of the oscillator tank circuit to the 6,300-kc frequency.

Note. Frequency Meter Set SCR-211 will produce beat notes between harmonics of the transmitter and the frequency meter. Care in the selection of the proper beat note frequency should be observed in order that improper alignment of the transmitter may be avoided.

(2) *P-a Tuning.* (a) Capacitor 81 is a trimmer across capacitor 75-B, the p-a grid circuit section of ganged tuning capacitor assembly.

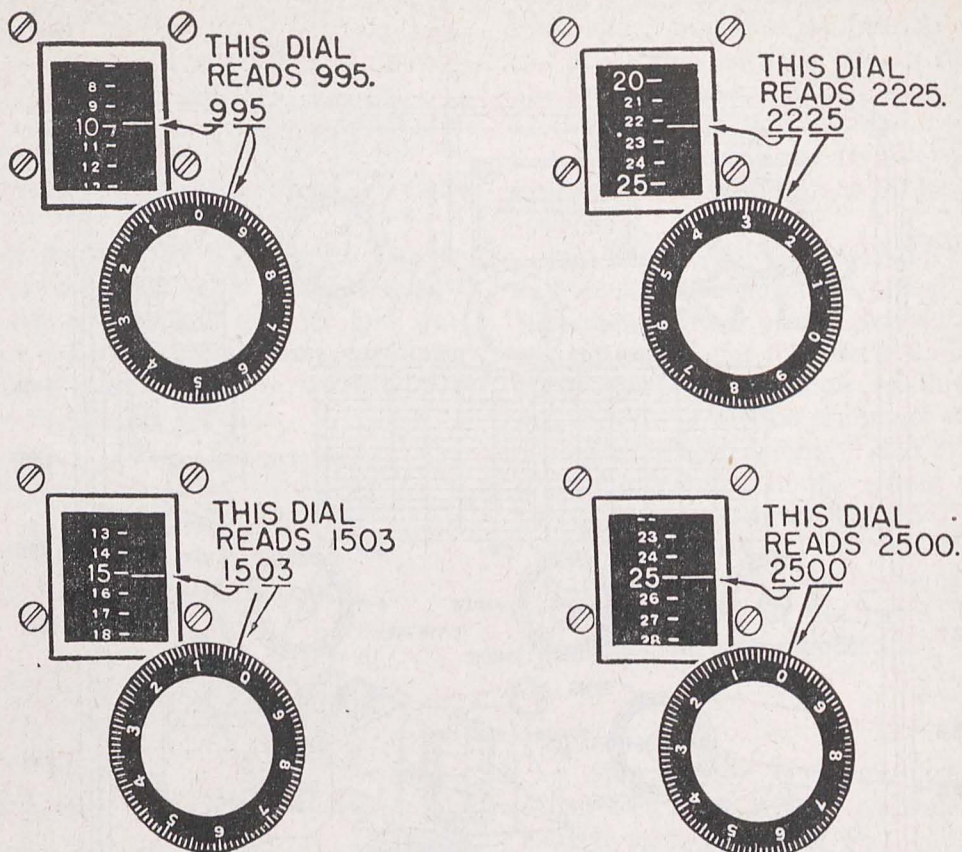

TL 70773

Figure 26. Dial readings for transmitter of Radio Receiver and Transmitter BC-1306.

Using the 75-volt d-c (direct-current) range of voltmeter, insert the negative lead to prong 5 and the positive lead to prong 7 of metering socket 143. Reference should be made to table IV. Using an insulated screw driver, peak the doubler grid circuit by carefully adjusting this trimmer (item 2, fig. 7) for *maximum* voltage reading of the voltmeter. This negative grid bias voltage may vary from minus 47 to minus 68 volts depending upon operating conditions and vacuum-tube tolerances.

(b) Capacitor 86 is a trimmer across capacitor 75-C, the p-a plate section of ganged tuning capacitor assembly. Using the 3-volt d-c scale of the voltmeter, connect the positive lead to prong 2 and the negative lead to prong 8 of metering socket 143. (See table IV.)

Caution: High voltage — exercise extreme care to avoid bodily contact to ground.

Using an insulated screw driver, carefully adjust this p-a trimmer (item 3, fig. 7) for *minimum* reading of the voltmeter. Normal voltage readings are 0.05 volt on PHONE and 0.14 volt

CW. This completes the alignment of the power amplifier. The transmitter is now fully aligned at 6,300 kc.

(3) *Operational test.* When these adjustments have been made, tune ANT. TUNING knob 131 for maximum brilliance as shown on indicator 159. Maximum light is visible when the two red spots on the barrel of the indicator cover are lined up. For minimum passage of light rotate the outer rim clockwise so the red spots are widely separated. This maximum brilliance should coincide with the maximum current reading on the thermocouple ammeter of the dummy load, r-f metering circuit. (See fig. 19.) The final frequency check should be made on each end of the frequency band. Retune the **FREQ. CONTROL** knob for each end frequency test, rotating knob 131 for maximum brilliance on each of these frequencies to make sure antenna resonance is secured at each end of the band. After the set has been properly aligned, turn off all power and disconnect all power cables.

SECTION VI

DETAILED TROUBLE-SHOOTING PROCEDURES

20. General

a. PURPOSE. The purpose of this section is to provide a systematic procedure for localizing trouble to a particular stage. When a faulty stage is found, see section VIII for the repair procedure.

b. RECEIVER. Since trouble in the first i-f amplifier stage, the calibrating oscillator stage, and the bfo stage is localized in aligning, no additional trouble-shooting procedure for these sections is given.

c. TRANSMITTER. Lack of audio-frequency power for modulating the transmitter may occur either in the modulator stage or in the suppressor grid of the p-a stage. Modulation faults are localized by resistance and voltage checks. (See sec. VIII.) Probing for r-f should be carried out in accordance with the procedure outlined in paragraph 23.

21. Receiver Second I-F Amplifier and Audio Stages

a. PREPARATION. (1) Use the hook-up and control settings described in paragraph 18.

(2) Set the signal generator to 456 kc with 30 percent, 400 cycles modulation and with maximum output voltage. Connect the ground of the signal generator to the GND. post of the receiver. Connect a clip lead in series with a .01-mf capacitor to the r-f post of the signal generator and clip it to terminal 6 of socket 61.

(3) Connect the ground of the a-c (alternating-current) vacuum-tube voltmeter to the GND. post of the receiver and the high post to an insulated test prod, in series with a .01-mf capacitor.

b. TEST AND INDICATION. If there is no indication on the output meter when alignment of the third i-f transformer is begun, apply the vacuum-tube voltmeter prod, successively, to the test points listed in table III, until a test point is found at which the voltmeter does not read.

Check the stage or section in which faulty operation is indicated against the data in section VIII.

Table III. Receiver second i-f amplifier and audio stages.

Apply voltmeter test prod to—	If voltmeter does not read, faulty operation is indicated for—
Terminal 3 of coil assembly 43-3.	2d i-f amplifier stage.
Terminal 3 of socket 62.	Transformer 43-3 or diode detector section of Tube JAN-1S5 stage.
Terminal 6 of socket 62.	Grid coupling section of Tube JAN-1S5 stage.
Terminal 5 of socket 62.	Plate section of Tube JAN-1S5 stage.
Terminal 3 of socket 63.	Grid-coupling section of audio-output stage.
Terminal 2 of socket 63.	Plate circuit of audio-output stage.
Terminal 5 of transformer 46.	Transformer 46 or associated wiring.
Tip of phone jack.	Switch 49 or associated wiring.

22. Receiver Radio-frequency and Converter Stages

a. PRELIMINARY. If, in aligning the receiver, the output meter does not read when the signal generator is applied to the antenna input of the receiver after the audio system has been checked, either the r-f amplifier stage or the h-f oscillator portion of the converter stage may be at fault. The following procedure should be used in localizing trouble to the faulty stage.

b. PREPARATION. (1) Use the hook-up and control settings described in paragraph 18.

(2) Set the receiver dial to 6.2 mc.

(3) Set the signal generator to 6.2 mc with 30 percent, 400 cycles modulation.

(4) Connect the high r-f post of the signal generator to an insulated test prod in series with a 250-mmf capacitor. Connect the ground post of the signal generator to the ground post of the receiver.

c. TEST AND INDICATION. (1) Apply the signal generator output, with a voltage of 1,000 microvolts, to terminal 6 of socket 59. If the output meter does not read, the oscillator section of the converter stage is faulty.

(2) If the output meter indicates when signal is applied to the mixer tube, but does not when the signal generator output at a voltage of 50 μ V (microvolts) is applied to antenna jack 52, the r-f amplifier stage is faulty.

23. Transmitter R-F Stages

a. PRELIMINARY. During all testing, it is imperative that the r-f output circuit be loaded. A dummy load r-f metering circuit (fig. 19) consisting of a 10.5-ohm, 20-watt carbon or non-inductive resistor in series with a 110-mmf capacitor and a 0-2 r-f ammeter is connected across the r-f output in place of the usual antenna. Probing for r-f is done with the aid of a neon lamp to locate the last point of r-f voltage. Probing should begin at the oscillator stage, continuing through the p-a stage, through the keying relay 156 and the antenna tuning network to the antenna post 158.

b. PREPARATION. (1) Remove transmitter from the case.

(2) Install the dummy load.

(3) Connect Cable CD-1086 to power receptacle 144.

(4) Set the panel controls as follows:

(a) MO-CRYSTALS switch 135 at MO.

(b) CW-MCW-PHONE switch 136 at CW.

(c) HIGH-MED.-LOW POWER switch 137 at HIGH.

(d) ANT. SELECTOR switch 139 at 1.

(e) FREQ. CONTROL knob at 6,000 kc.

(5) Insert KEY cable plug into jack 150.

(6) Turn power ON and close key circuit.

(7) Rotate ANT. TUNING knob 131 to ascertain any resonance.

c. TESTS AND INDICATION. (1) *Oscillator stage.* If there is little or no r-f indication on indicator 159, or on the thermocouple ammeter of metering circuit, it should first be ascertained that this stage is operative as its r-f output furnishes excitation and d-c bias to the grid circuit of the p-a stage. The keying circuit should not remain closed for long periods until the trouble is localized, otherwise damage will result to the p-a tube and its component parts.

Probe with a neon lamp at the plate output circuit, working backward to the grid input circuit, to find where r-f is lost. Upon localizing

any trouble, see paragraph 35, and correct the fault. Crystal operation should then be checked by selecting the crystal frequencies as noted on socket 149 cover, with switch 135, and setting the FREQ. CONTROL knob to the proper dial reading indicated on the calibration chart on the front panel and figure 27.

FREQ	00KC	20KC	40KC	60KC	80KC	FREQ	00KC	20KC	40KC	60KC	80KC
3800	168	208	247	284	321	5200	1912	1929	1945	1962	1977
3900	358	393	429	463	497	5300	1993	2009	2025	2041	2057
4000	532	564	596	629	660	5400	2072	2088	2103	2119	2135
4100	691	722	752	781	811	5500	2150	2165	2180	2195	2210
4200	840	869	897	925	954	5600	2225	2240	2254	2269	2283
4300	979	1005	1032	1058	1084	5700	2297	2312	2326	2340	2355
4400	1109	1134	1159	1183	1207	5800	2369	2383	2397	2411	2425
4500	1231	1254	1277	1300	1323	5900	2439	2453	2466	2480	2494
4600	1345	1367	1389	1411	1432	6000	2509	2522	2535	2549	2562
4700	1453	1474	1494	1515	1535	6100	2576	2589	2603	2617	2630
4800	1555	1575	1593	1613	1632	6200	2643	2656	2670	2684	2695
4900	1650	1668	1686	1705	1723	6300	2709	2723	2736	2750	2763
5000	1741	1759	1776	1794	1811	6400	2777	2790	2804	2820	2836
5100	1829	1846	1863	1879	1895	6500	2854				

1L 70752

Figure 27. Frequency calibration chart for transmitter of Radio Receiver and Transmitter BC-1306.

(2) *P-a stage.* R-f tracing with a neon lamp is first checked at the grid of Tube JAN-2E22. Continue tracing in turn at the plate cap of Tube JAN-2E22 (*danger, high voltage, exercise care to avoid bodily contact*), terminals Nos. 1 and 3 of coil 127 and capacitor 87. Lack of r-f voltage at any of these points should be localized (par. 36), and the fault corrected.

(3) *Antenna-tuning network.* R-f output of the p-a stage enters the antenna-tuning network via keying relay 156. Continue tracing for r-f with a neon lamp through relay 156, coil 131, coil 124, and switch 139 to antenna post 158. Where r-f is lost, see paragraph 37, and remedy the fault.

24. Moistureproofing, Fungiproofing, and Refinishing

After repairs have been completed on the receiver and transmitter, check the date of last moistureproofing, fungiproofing, and refinishing treatment. If a new treatment is required see TB SIG 13 and TM 11-230C, for methods of application. If the case has been chipped or scarred, remove all rough spots with fine sandpaper and apply paint to these spots with a small brush. If the case is sufficiently scarred or scratched to warrant complete refinishing, remove receiver and transmitter units from the case. Remove all rust and dirt accumulations with kerosene where necessary and spray the entire case with the proper paint authorized by existing regulations.

SECTION VII

FINAL TESTING

25. Alignment Check

Although the receiver and transmitter units were correctly aligned during the repair procedure, a recheck of the alignment of each unit is necessary after moistureproofing and fungi-proofing have been completed. Check alignment as given in section V.

26. Final Testing (Transmitter)

a. TESTS. Upon completion of the alignment check, the following transmitter performance tests are to be made:

Metering socket 143 readings.

Filament voltage regulation.

Power output.

Modulation capability (MCW).

Modulation capability (PHONE).

Calibration accuracy test.

Sidetone frequency and output.

Transmitter operational test.

b. METERING SOCKET 143 READINGS. (1)

Preparation. (a) Transmitter is removed from the case.

(b) Set MO-CRYSTALS switch 135 at MO.

(c) Set CW-MCW-PHONE switch 136 at PHONE.

(d) Set HIGH-MED.-LOW POWER switch 137 at HIGH.

(e) Set SEND-STANDBY-OFF switch 138 at SEND.

(f) Set FREQ. CONTROL at 6,000 kc.

(g) Insert KEY cord plug in jack 150.

(h) Install Cord CD-1086 in power receptacle 144 and connect to source of power, either PE-237 or PE-162.

(i) Turn power on.

(j) Close key circuit.

(2) *Test.* (a) Using a 1,000-ohm-per-volt voltmeter, readings must be shown as in table IV.

(b) Limits specified on p-a plate voltage, p-a

plate current, and p-a grid voltage are to remain constant over the entire frequency range.

(c) Turn power OFF at source and open the key circuit at the end of test.

Table IV. Metering socket 143 readings.

Test	Voltmeter scale	Contacts	Voltmeter indication
p-a plate volts	750 v	8(+) 7(-)	500 v
p-a plate current	3 v	2(+) 8(-)	0.2 v (max)
p-a screen grid volts	500 v	3(+) 7(-)	150 to 220 v
p-a suppressor grid volts	75 v	4(-) 7(+)	34.5 to 44.5
p-a grid volts	75 v	5(-) 7(+)	47 to 68 v

c. FILAMENT VOLTAGE REGULATOR. (1) *Preparation.* (a) Set the 1,000-ohm-per-volt voltmeter to the 3-volt range. Connect the negative lead to the junction of 157 and 128 (fig. 9) and the positive lead to chassis.

(b) Turn power on and close the key circuit.

(2) *Test.* (a) The voltmeter must indicate not less than 1.2 nor more than 1.6 volts.

(b) Open key circuit and remove modulator tube shield and tube from socket 141. (See fig. 6.)

(c) Close key circuit. The new voltmeter indication must not exceed 2.2 volts.

(d) Open key circuit and turn power off. Remove Cord CD-1086 from power source. Replace modulator tube and shield in socket 141. Replace transmitter in case.

d. POWER OUTPUT. (1) *Preparation.* (a) Set ANT. SELECTOR switch 139 to position 1.

(b) Install dummy load r-f metering circuit consisting of a 10.5-ohm, 20-watt carbon or noninductive resistor in series with a 110-mmf capacitor and a 0-2 r-f ammeter across antenna post 158 and ground. (See fig. 19.)

(c) Set FREQ. CONTROL at 6,000 kc.

(d) Reconnect Cord CD-1086 to power

source, turn power ON, and close the key circuit.

(e) Rotate ANT. TUNING knob 131 for maximum indication on r-f ammeter.

(2) *Test.* (a) The r-f output as indicated by the ammeter must not be less than the values specified in table V.

Table V. R-f ammeter readings.

Switch 136	Switch 137	Minimum r-f current (amperes)
CW	HIGH	1.38
CW	MED.	Check for current reduction.
CW	LOW	Check for current reduction.
PHONE	HIGH	0.82

(b) Open key circuit and turn switch 138 to OFF.

e. MODULATION CAPABILITY (MCW). (1) *Preparation.* (a) With all other control settings unchanged, set switch 136 to MCW, switch 137 to HIGH, and rotate FREQ. CONTROL knob to 5,200 kc.

(b) Connect a lead to the "high" vertical plate of an oscilloscope and loosely couple its other end to the r-f output. Connect the other vertical plate to the chassis ground.

Note. The oscilloscope vertical amplifier is *not* used when r-f is being observed.

(c) Set switch 138 to SEND and close its key circuit.

(d) Tune ANT. TUNING knob 131 for maximum indication on the r-f ammeter.

(e) Vary coupling to the r-f output to obtain a satisfactory image on the oscilloscope and adjust the sweep frequency to obtain the modulation envelope pattern.

Note. If difficulty is encountered in obtaining a stable pattern on the oscilloscope screen, the following procedure should be followed: Connect the receiver to the transmitter by means of the circuit test cable. (See fig. 20.) Connect the tip of a phone Plug PL-55 to the external synchronizing binding post of the oscilloscope and the sleeve of the plug to the oscilloscope ground terminal. Insert the phone plug into one of the receiver PHONE jacks. Then adjust the oscilloscope synchronizing control until a stable pattern is obtained.

(2) *Test.* (a) The pattern must indicate between 70 and 110 percent sinusoidal modulation. Check against patterns of figure 28.

(b) Open key circuit and turn switch 138 to OFF.

f. MODULATION CAPABILITY (PHONE). (1) *Preparation.* (a) With all other control settings unchanged, set switch 136 to PHONE.

(b) The oscilloscope remains connected as in the previous test.

(c) Plug audio oscillator test circuit (fig. 29) into MIKE jack 151.

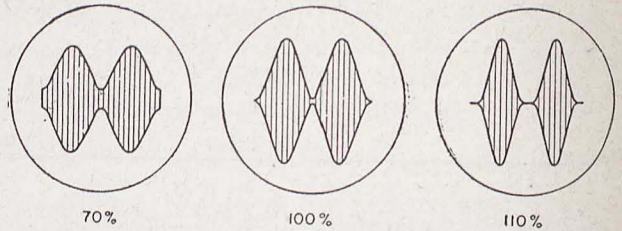

Figure 28. Modulation patterns of transmitter of Radio Receiver and Transmitter BC-1306.

(d) Set switch 138 to SEND and close KEY circuit.

(2) *Test.* (a) Set the audio frequency oscillator to 400 cycles and adjust its output until a 100 percent modulation pattern is obtained. The vacuum-tube voltmeter must not indicate more than 0.45 volt.

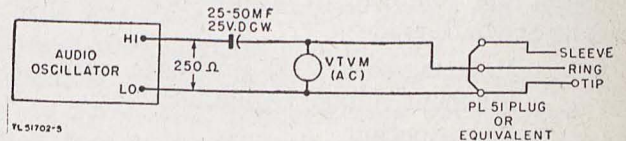

Figure 29. Audio oscillator test circuit for transmitter of Radio Receiver and Transmitter BC-1306.

(b) Repeat step (a) above, at audio frequencies of 1 kc, 2 kc and 3 kc. The audio-frequency oscillator output necessary for 100 percent modulation at each of these frequencies must not exceed 0.45 volt.

(c) Check oscilloscope pattern for sinusoidal modulation.

(d) Turn switch 138 to OFF and remove audio oscillator test circuit plug from MIKE jack 151. Turn OFF power source.

g. CALIBRATION ACCURACY. (1) *Preparation.* (a) Connect receiver to power plug, antenna plug, and ground plug by means of circuit test cable. (See fig. 13.)

(b) Insert headphone plug into one of receiver PHONE jacks.

(c) Turn power source ON and set switch 138 to STANDBY.

(d) Turn switch 136 to CW.

(2) *Test.* (a) Set the receiver PHONE-CW-NET-CAL switch to CAL.

(b) Tune the receiver dial to 6,400 kc as determined by the zero beat nearest the receiver 6,400 kc dial marking. Set the receiver sensitivity switch to the lowest value giving a clear beat so that spurious beats will not be heard.

(c) Leave the receiver dial at this setting and reset the receiver PHONE-CW-NET-CAL switch to NET.

(d) Turn the transmitter FREQ. CONTROL knob until the transmitter dial setting corresponds to 6,400 kc. (See transmitter frequency calibration chart, fig. 27.)

(e) Adjust CAL trimmer 77 until zero beat is obtained with the headset. (See fig. 25.)

(f) Reset the receiver PHONE-CW-NET-CAL switch to CAL and tune the receiver dial to 6,200 kc as determined by the zero beat nearest the receiver 6,200 kc dial marking.

(g) Leave the receiver dial at this setting and turn the receiver PHONE-CW-NET-CAL switch to NET.

(h) Rotate the transmitter FREQ. CONTROL knob until zero beat is obtained. The transmitter dial setting must now be within ± 3.2 kc of the calibrated 6,200 kc point. (See transmitter frequency calibration chart, fig. 27.)

(i) Repeat steps (a) to (e) above, adjusting for exact tracking at 3,800 kc.

(j) Reset the receiver PHONE-CW-NET-CAL switch to CAL and tune the receiver dial to 4,000 kc as determined by the zero beat nearest the receiver 4,000 kc dial marking.

(k) Leave the receiver dial at this setting and turn the receiver PHONE-CW-NET-CAL switch to NET.

(l) Turn the transmitter FREQ. CONTROL knob until zero beat is obtained. The transmitter dial setting must now be within ± 2 kc of the calibrated 4,000 kc point. (See transmitter frequency calibration chart, fig. 27.)

(m) Turn the power source OFF and turn switch 138 to OFF.

h. SIDETONE FREQUENCY AND OUTPUT. (1) Preparation. (a) Set receiver IMPEDANCE switch 49 to 4,000 ohms.

(b) Connect test apparatus as shown in figure 30.

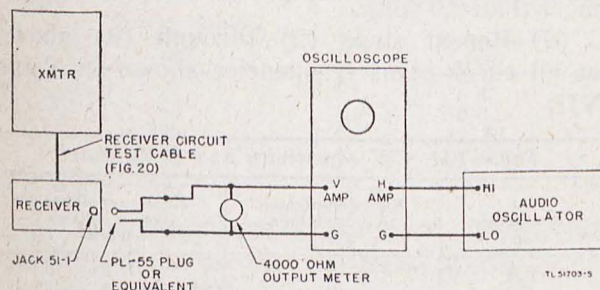

Figure 30. Sidetone test set-up for transmitter of Radio Receiver and Transmitter BC-1306.

(c) Set SIDETONE control 115 to its maximum clockwise position. (See fig. 25.)

(d) Rotate the FREQ. CONTROL knob to 5,200 kc.

(e) Turn ON the power source, set switch 138 to SEND and close the key circuit.

(f) Tune ANT. TUNING knob 131 for maximum indication on the r-f ammeter.

(2) *Test.* (a) The 4,000-ohm output meter must not read less than 4.2 volts with switch 136 in either the MCW or CW positions.

(b) Measure the sidetone frequency on the oscilloscope, varying the audio-oscillator frequency to obtain an elliptical pattern. The sidetone frequency must not be less than 600 cycles, nor more than 850 cycles.

(c) Open the key circuit, set switch 138 to OFF and turn off power source. Disconnect the output meter, oscilloscope, and audio oscillator from the receiver.

i. TRANSMITTER OPERATIONAL TEST. (1) Preparation. (a) With all other control settings unchanged, set switch 137 to LOW.

(b) Set up a short-wave receiver in the vicinity of the transmitter so that CW and PHONE signals from the transmitter of Radio Receiver and Transmitter BC-1306 may be monitored.

(c) Insert microphone in MIKE jack 151.

(d) Turn on power source and set switch 138 to SEND.

(2) *Test.* (a) With switch 136 set at MCW, close the key circuit. Tune the monitoring receiver to the transmitter frequency. Set switch 137 to MED. or HIGH if the received signal is too weak.

(b) Open key circuit. Set switch 136 to PHONE, press microphone switch and talk clearly into the microphone. An assistant at the monitoring receiver should check for clear undistorted reception.

(c) Set switch 136 to MCW. Key the transmitter at speeds up to 25 words per minute and check that there is no tendency towards chopping off of characters at this speed.

(d) Repeat (c) above, with switch 136 set to CW.

(e) Insert a crystal whose frequency lies in the range 3.8–6.5 mc in crystal socket A of the transmitter. Set switch 135 to position A and rotate FREQ. CONTROL knob until maximum indication on the r-f ammeter is obtained. Vary ANT. TUNING knob 131 to still further increase the r-f ammeter indication. Tune the

monitoring receiver to the crystal frequency.

(f) Repeat steps (c) and (d) above, with crystal-controlled operation of the transmitter.

(g) Set switch 138 to OFF and turn off the power source.

(h) Disconnect Cord CD-1086 and dummy load from the transmitter. Remove key from jack 150 and microphone from jack 151. Turn off the monitoring receiver.

27. Final Testing (Receiver)

a. TESTS. Upon completion of the final testing of the transmitter, the following receiver performance tests are to be made:

Sensitivity and noise (PHONE).

Sensitivity and noise (CW).

Sensitivity switch ratio.

Selectivity.

I-f rejection ratio.

Image rejection ratio.

Microphonics.

Calibration oscillator output and dial calibration.

Receiver operational test.

b. PREPARATION. (1) Restore the bottom plate of receiver.

(2) Connect receiver to power plug, antenna plug, and ground plug by means of circuit test cable. (See fig. 20.)

(3) Connect a 4,000-ohm output meter to a phone plug and insert it into one of the PHONE jacks.

(4) Supply power to the set with Battery BA-48, connecting Cord CD-1119 to battery receptacle 145 on the transmitter panel.

(5) Connect the HI r-f output post of the signal generator, in series with a 110-mmf capacitor, to antenna post 158 on the transmitter panel.

(6) Receiver plate voltage is set at 105 volts d-c. Receiver filament voltage is set at 1.4 volts d-c.

c. CONTROL SETTING. Except where otherwise specified, the following control settings are to be maintained: SEND-STANDBY-OFF switch, of the transmitter, at STANDBY; receiver PHONE-CW-NET-CAL switch at PHONE; SENSITIVITY switch at HIGH; VOLUME control in maximum clockwise position; IMPEDANCE switch on the back of the receiver at 4000; ANT. SELECTOR switch on transmitter at position 1.

d. SENSITIVITY AND NOISE (PHONE). (1)

Set the PHONE-CW-NET-CAL switch at PHONE.

(2) Set the signal generator output voltage to 5 μ v at 6.2 mc with 30 percent, 400 cycles modulation, and tune the receiver to this input frequency.

(3) Set the VOLUME control so that the output meter indicates 6.3 volts.

(4) Turn off the modulation of the signal generator. The output meter reading must not be more than 2.0 volts.

(5) Repeat steps (2) through (4) above, at all check-point frequencies shown in table VI,

Table VI. Phone sensitivity and noise chart.

Frequency (mc)	Signal generator output voltage (mv)	Maximum allowable noise voltage (volts)
6.4	5	2.0
5.2	5	2.0
3.8	5	2.0

e. SENSITIVITY AND NOISE (CW). (1) Set the PHONE-CW-NET-CAL switch at PHONE.

(2) Set the signal generator output to 6.2 mc with 30 percent, 400 cycles modulation, and tune the receiver to this input frequency.

(3) Plug a pair of earphones into the receiver phone jack and become familiar with the sound of a 400-cycle note. If Headset HS-30 with Cord CD-933 is used, set the IMPEDANCE switch to 250 ohms for better audibility.

(4) Turn off the modulation of the signal generator. Set the PHONE-CW-NET-CAL switch at CW. Tune for a 400-cycle beat note.

(5) Increase the output voltage of the signal generator to 0.5 volts. The beat note must remain clear.

(6) Unplug the earphones and reset the IMPEDANCE switch to 4,000 ohms.

(7) Reduce the signal generator output voltage to 3 μ v. Set the VOLUME control so that the output meter reads 6.3 volts.

(8) Turn off the output of the signal generator. The output meter reading must not be more than 2.0 volts.

(9) Repeat steps (2) through (8) above, at all check-point frequencies shown in Table VII.

Table VII. CW sensitivity and noise chart.

Frequency (mc)	Signal generator output voltage (mv)	Maximum allowable noise voltage (volts)
6.4	3	2
5.2	3	2
3.8	3	2

f. SENSITIVITY SWITCH RATIO. (1) Set the PHONE-CW-NET-CAL switch at PHONE.

(2) Set the signal generator output to 10 μV at 5.2 mc with 30 percent, 400 cycles modulation, and tune the receiver to this input frequency.

(3) Set the VOLUME control so that the output meter indicates 6.3 volts.

(4) Set the SENSITIVITY switch to MED. and increase the signal generator output until the output meter reading returns to 6.3 volts. The signal generator's output voltage must not be less than 50 μV .

(5) Set the SENSITIVITY switch to LOW and increase the signal generator output until the output meter reading returns to 6.3 volts. The signal generator's output voltage must not be less than 1,000 μV .

g. SELECTIVITY. (1) Set the PHONE-CW-NET-CAL switch at PHONE.

(2) Set the signal generator output voltage to 5 μV at 5.2 mc with 30 percent, 400 cycles modulation and tune the receiver to this input frequency.

(3) Set the VOLUME control so that the output meter indicates 6.3 volts.

(4) Increase the output voltage of the signal generator to 10 μV .

(5) Leaving the TUNING knob of the receiver unchanged, vary the frequency of the signal generator on either side of 5.2 mc until the output voltage returns to 6.3 volts. Note the two dial settings of the signal generator at which this occurs.

(6) Subtract the smaller dial setting from the larger. The difference (or selectance) must be between 3 and 6 kc.

(7) Repeat steps (4) through (6) above, increasing the output of the signal generator to each of the values listed in table VIII, and checking for the required selectances.

Table VIII. Selectivity.

Signal generator voltage (mv)	Selectance (kc)
10	3-6
50	7.5-11
500	12-20
5,000	15-30

h. INTERMEDIATE - FREQUENCY REJECTION RATIO. (1) Sets the PHONE-CW-NET-CAL switch at PHONE.

(2) Set the signal generator output voltage

to 10 μV at 6.5 mc with 30 percent, 400 cycles modulation, and tune the receiver to this frequency.

(3) Set the VOLUME control so that the output meter indicates 6.3 volts.

(4) With the receiver settings unchanged, shift the frequency of the signal generator to 456 kc and increase its voltage output to 1 volt.

(5) Vary the frequency of the signal generator slightly above and below 456 kc until the output meter reads a maximum value. This reading must not be more than 6.3 volts.

(6) Repeat steps (2) through (5) above, with the receiver tuned to the frequencies shown in table IX.

Table IX. Intermediate-frequency rejection ratio.

Test frequency (mc)	Test frequency input (mv)	Intermediate-frequency input (volts)	Maximum output meter reading (volts)
6.5	10	1.0	6.3
5.2	10	1.0	6.3
5.8	10	1.0	6.3

i. IMAGE REJECTION RATIO. (1) Set the PHONE-CW-NET-CAL switch at PHONE.

(2) Adjust the signal generator's output voltage to 10 μV at 6.5 mc with 30 percent, 400 cycles modulation, and tune the receiver to this input frequency.

(3) Adjust the VOLUME control so that the output meter indicates 6.3 volts.

(4) Adjust the generator frequency to 7.412 mc, the image-frequency. (The image-frequency is the signal frequency plus twice the i-f frequency.)

(5) Increase the signal generator output to 6,000 μV . Vary the frequency of the signal generator slightly above and below 7.412 mc until the output meter reads maximum value.

(6) The output meter must not read more than 6.3 volts.

(7) Repeat steps (2) through (6) above, at each of the frequencies listed in table X.

Table X. Image rejection ratio.

Signal frequency (mc)	Image frequency (mc)	Signal frequency input (mv)	Image frequency input (mv)	Maximum output meter reading (volts)
6.500	7.412	10	5,000	6.3
5.200	6.112	10	5,000	6.3
3.800	4.712	10	5,000	6.3

j. MICROPHONICS. (1) Set PHONE-CW-NET-CAL switch at PHONE.

(2) Set the signal generator's output voltage to 10,000 μV at 5.2 mc with 30 percent, 400 cycles modulation, and tune the receiver to this frequency.

(3) Set the VOLUME control so that the output meter indicates 14.1 volts.

(4) Unplug the output meter and plug in a headset. Adjust the IMPEDANCE switch to match the proper impedance of the headset.

(5) Turn modulation off. Proceed to tap or slap side of receiver and note whether objectionable microphonic noises are heard in the headset.

(6) Microphonic tubes are distinguished by a sustained feedback and should be replaced.

k. CALIBRATION OSCILLATOR OUTPUT AND DIAL CALIBRATION. (1) Disconnect the signal generator.

(2) Set the PHONE-CW-NET-CAL switch at CAL.

(3) Plug a set of earphones into one of the PHONE jacks.

(4) Turn the receiver's dial to 3.8 mc, and tune for zero beat. This should occur within ± 30 kc of the 3.8 mc dial marking.

(5) Turn the receiver tuning knob slightly until a beat note of approximately 400 cycles is heard. Unplug the earphones.

(6) Set the IMPEDANCE switch at 4000. The output meter must not read less than 4.1 volts.

(7) Repeat steps (3) through (6) above, at each of the check-point frequencies of table XI.

Table XI. Calibration oscillator output and dial calibration.

Frequency (mc)	Maximum dial deviation (kc)	Minimum output meter reading (volts)
3.8	± 30	4.1
5.2	± 30	4.1
6.4	± 30	4.1

(8) Disconnect the output meter and headset from the PHONE jacks. Turn the OFF-STANDBY-SEND switch of the transmitter to OFF. Disconnect the receiver test cable.

l. RECEIVER OPERATIONAL TEST. (1) With IMPEDANCE switch set at 250, replace receiver in case. Enter all plug-in connections properly without forcing. Secure the four retaining rings on case.

(2) Turn OFF-STANDBY-SEND switch on transmitter panel to STANDBY.

(3) Connect a suitable antenna to the antenna post 158 on the transmitter panel.

(4) Plug a headset into one of the PHONE jacks.

(5) With the PHONE-CW-NET-CAL switch in the PHONE position, rotate the TUNING knob until a station is tuned in.

(6) Check that the receiver output is not excessively distorted and is free of howls, squeals, and intermittent noises. Rotate the VOLUME control back and forth and check that there are no intermittent noises at any setting.

(7) Reset the PHONE-CW-NET-CAL switch to the CW position; tune in a c-w station and again check for normal operation.

(8) Push DIAL LIGHT switch 50 and check that pilot light goes on.

(9) Turn OFF-STANDBY-SEND switch on the transmitter panel to OFF. Disconnect the headset and Cord CD-1119.

INDEX

CONTENTS OF VOLUME I

Introduction	1
Chapter I. The Nature of the Problem	15
Chapter II. The Method of Solution	35
Chapter III. The Results of the Investigation	55
Chapter IV. The Conclusions of the Study	75
Appendix A. Data and Calculations	95
Appendix B. Diagrams and Figures	115
Appendix C. Tables of Values	135
Appendix D. Bibliography	155
Appendix E. Glossary	175
Appendix F. Index	195

SECTION VIII

INDIVIDUAL STAGE AND CIRCUIT REPAIR DATA

28. Receiver R-F Amplifier Stage

a. STAGE DATA. (1) R-f stage schematic, figure 31.

(2) Voltage and resistance values for socket 58, stage schematic.

(3) Parts data for r-f amplifier stage, table XII.

b. TROUBLE LOCATION. (1) *Tube check.* Remove the tube from socket. Test it with the tube checker and replace with a new tube if necessary. In replacing the tube, see that it is seated firmly in its socket.

(2) *Tube socket voltage and resistance check.* Check the voltages and resistances from the socket terminals to ground. After trouble has been localized to a particular portion of the stage, make a check of each individual component associated with that portion of the stage. The voltage of terminal 6 of socket 58 may have an appreciable negative value when measured with a d-c vacuum-tube voltmeter. Check the resistance of terminal 6 of socket 58 to ground with the tuning capacitor in various positions, thus checking for shorts between rotor and stator plates.

(3) *Point-to-point continuity check.* If the preceding steps fail to indicate the cause of trouble, perform a point-to-point continuity check, referring to the stage schematic and to the parts identification drawing, figure 22. Check for broken leads, faulty soldered joints and shorts. Capacitor 1-A is the rear section of the main tuning capacitor, and capacitor 2 is the trimmer mounted on the same section of the gang.

(4) *Low gain.* Use the test hook-up described in paragraph 18*a*. Connect the HI r-f output of the signal generator to the receiver antenna post in series with a 250-mmf dummy antenna. Set the signal generator to 5.2 mc with 30 percent, 400 cycles modulation, and tune the receiver to this frequency. Note whether the indication of the output meter increases sharply with any of the following steps, indicating an open bypass capacitor.

(*a*) Connect a 0.01-mf capacitor in parallel with capacitor 8-1.

(*b*) Connect a 0.01-mf capacitor in parallel with capacitor 9-1.

29. Receiver Mixer, H-F Oscillator Stage

a. STAGE DATA. (1) Mixer-oscillator stage schematic, figure 32.

(2) Voltage and resistance values for socket 59, stage schematic.

(3) Parts data for mixer-oscillator stage, table XIII.

b. TROUBLE LOCATION. (1) *Tube check.* Remove the tube from socket. Test it with the tube checker and replace with a new tube if necessary. In replacing tube see that it is seated firmly in its socket.

(2) *Tube socket voltage and resistance check.* Check the voltages and resistances from the socket terminals to ground. After trouble has been localized to a particular portion of the stage, make a check of each individual component associated with that portion of the stage. The voltage of terminal 4 of socket 59 will have an appreciable negative value, as measured on a d-c vacuum-tube voltmeter when the circuit is

oscillating properly. Check the resistance of terminal 6 of socket 59 with the tuning capacitor in various positions, thus checking for shorts between rotor and stator plates.

(3) *Point-to-point continuity check.* If the preceding steps fail to indicate the cause of trouble, perform a point-to-point continuity check, referring to the stage schematic and to the parts identification drawing, figure 22. Check for broken leads, faulty soldered joints, and shorts. Capacitor 1-B is the center section of the main tuning capacitor.

(4) *No oscillation.* Check capacitor 1-C for an accidental ground between rotor and stator. Check the wiring to terminals 5 and 2 of transformer 42 for accidental grounds. Check capacitor 8-2 by connecting a 0.01-mf capacitor in parallel with it.

(5) *Blocking and motorboating.* If the capacity of capacitor 10 is too large, or if resistor 28-2 is disconnected or makes only intermittent connection, blocking may occur.

30. Receiver First I-F Amplifier Stage

a. STAGE DATA. (1) First i-f amplifier stage schematic, figure 33.

(2) Voltage and resistance values for socket 60, stage schematic.

(3) Parts data for first i-f amplifier stage, table XIV.

b. TROUBLE LOCATION. (1) *Tube check.* Remove the tube from socket. Test it with the tube checker and replace with a new tube if necessary. In replacing tube see that it is seated firmly in its socket.

(2) *Tube socket voltage and resistance check.* Check the voltages and resistances from

the socket terminals to ground. After trouble has been localized to a particular portion of the stage, make a check of each individual component associated with that portion of the stage. The voltage of terminal 6 of socket 60 may have an appreciable negative value when measured with a d-c vacuum-tube voltmeter.

(3) *Point-to-point continuity check.* If the preceding steps fail to indicate the cause of trouble, perform a point-to-point continuity check, referring to the stage schematic and to the parts identification drawing, figure 22. Check for broken leads, faulty soldered joints and shorts.

31. Receiver Second I-F Amplifier and Crystal Calibrator Stage

a. STAGE DATA. (1) Second i-f amplifier and crystal calibrator stage schematic, figure 34.

(2) Voltage and resistance values for socket 61, stage schematic.

(3) Parts data for second i-f amplifier and crystal calibrator stage, table XV.

b. TROUBLE LOCATION. (1) *Tube check.* Remove the tube from socket. Test it with the tube checker and replace with a new tube if necessary. In replacing tube, see that it is seated firmly in its socket.

(2) *Tube socket voltage and resistance check.* Check the voltages and resistances from the socket terminals to ground. After trouble has been localized to a particular portion of the stage, make a check of each individual component associated with that portion of the stage. The voltage of terminal 4 of socket 61 will have an appreciable negative value, as measured with a d-c vacuum-tube voltmeter, when the PHONE-CW-NET-CAL switch is set at CAL.

(3) *Point-to-point continuity check.* If the preceding steps fail to indicate the cause of trouble, perform a point-to-point continuity check, referring to the stage schematic and to the parts identification drawing, figure 22. Check for broken leads, faulty soldered joints and shorts.

(4) *Low gain.* Check capacitor 8-9 for open circuit by connecting a 0.01-mf capacitor in parallel with it and noting the effect upon the output.

(5) *No oscillation.* If there is no crystal calibrator output, make the following checks:

(a) Check the resistance to ground from the end of capacitor 8-4 which is connected to the PHONE-CW-NET-CAL switch. This resistance should be zero except in the CAL position, when it should be infinite.

(b) Check capacitor 12 for open circuit by connecting a 300-mmf capacitor in parallel and noting the effect upon the output.

(c) Check capacitor 11 for open circuit by connecting a 30-mmf capacitor in parallel with it and noting the effect upon the output.

32. Receiver Detector, First A-F Amplifier, A-V-C, BFO Stage

a. STAGE DATA. (1) Detector, first a-f, a-v-c, bfo stage schematic, figure 35.

(2) Voltage and resistance values for socket 62, stage schematic.

(3) Parts data for detector, first a-f, a-v-c, and bfo stage, table XVI.

b. TROUBLE LOCATION. (1) *Tube check*. Remove the tube from socket. Test it with the tube checker and replace with a new tube if necessary. In replacing tube, see that it is seated firmly in its socket.

(2) *Tube socket voltage and resistance check*. Check the voltages and resistances from the socket terminals to ground. After trouble has been localized to a particular portion of the stage, make a check of each individual component associated with that portion of the stage. The voltage of terminal 3 of socket 62

may have an appreciable negative value when measured with a d-c vacuum-tube voltmeter.

(3) *Point-to-point continuity check*. If the preceding steps fail to indicate the cause of trouble, perform a point-to-point continuity check, referring to the stage schematic and to the parts identification drawing, figure 22. Check for broken leads, faulty soldered joints, and shorts.

(4) *No beat-frequency oscillation or low-audio gain*. Check capacitor 8-6 for open circuit by paralleling with a 0.01-mf capacitor and noting the effect upon the output.

(5) *Coarse beat note*. Check to see that capacitor 13-2 is connected properly. Parallel it with a 100-mmf capacitor and note the effect upon the output.

(6) *Motorboating*. This trouble may be due to open or intermittent connections in the grid circuit. Check grid returns.

33. Receiver Audio-Output Amplifier Stage

a. STAGE DATA. (1) Audio-output amplifier stage schematic, figure 36.

(2) Voltage and resistance values for socket 63, stage schematic.

(3) Parts data for audio output amplifier stage, table XVII.

b. TROUBLE LOCATION. (1) *Tube check*. Remove the tube from socket. Test it with the tube checker and replace with a new tube if necessary. In replacing tube, see that it is seated firmly in its socket.

(2) *Tube socket voltage and resistance check*. Check the voltages and resistances from the socket terminals to ground. After trouble has been localized to a particular portion of the

stage, make a check of each individual component associated with that portion of the stage.

(3) *Point-to-point continuity check*. If the preceding steps fail to indicate the cause of trouble, perform a point-to-point continuity check, referring to the stage schematic and to the parts identification drawing, figure 22. Check for broken leads, faulty soldered joints, and shorts.

(4) *Low gain*. If low gain is suspected for this stage, check capacitors 9-2 and 9-3 for open circuits by connecting a 0.01-mf capacitor in parallel with each and noting the effect upon the output.

(5) *Motorboating*. This trouble may be due to open or intermittent connections in the grid circuit. Check grid returns.

34. Receiver Power and Switching Connections

a. STAGE DATA. (1) Power and switching connections schematic, figure 38.

(2) Details of switches 47 and 48, figure 37.

(3) Voltage and resistance values for plug 54, on stage schematic.

(4) Parts data for power and switching connections, table XVIII.

b. TROUBLE LOCATION. (1) *Improper sensitivity switch ratio.* Perform a point-to-point continuity check of the wiring to switch 47.

(2) *Noise and regeneration.* If the receiver is noisy, or has regenerative squeals, a possible cause is capacitor 20 being open. Check by paralleling with a 1,000-mf capacitor and noting the effect upon the noise.

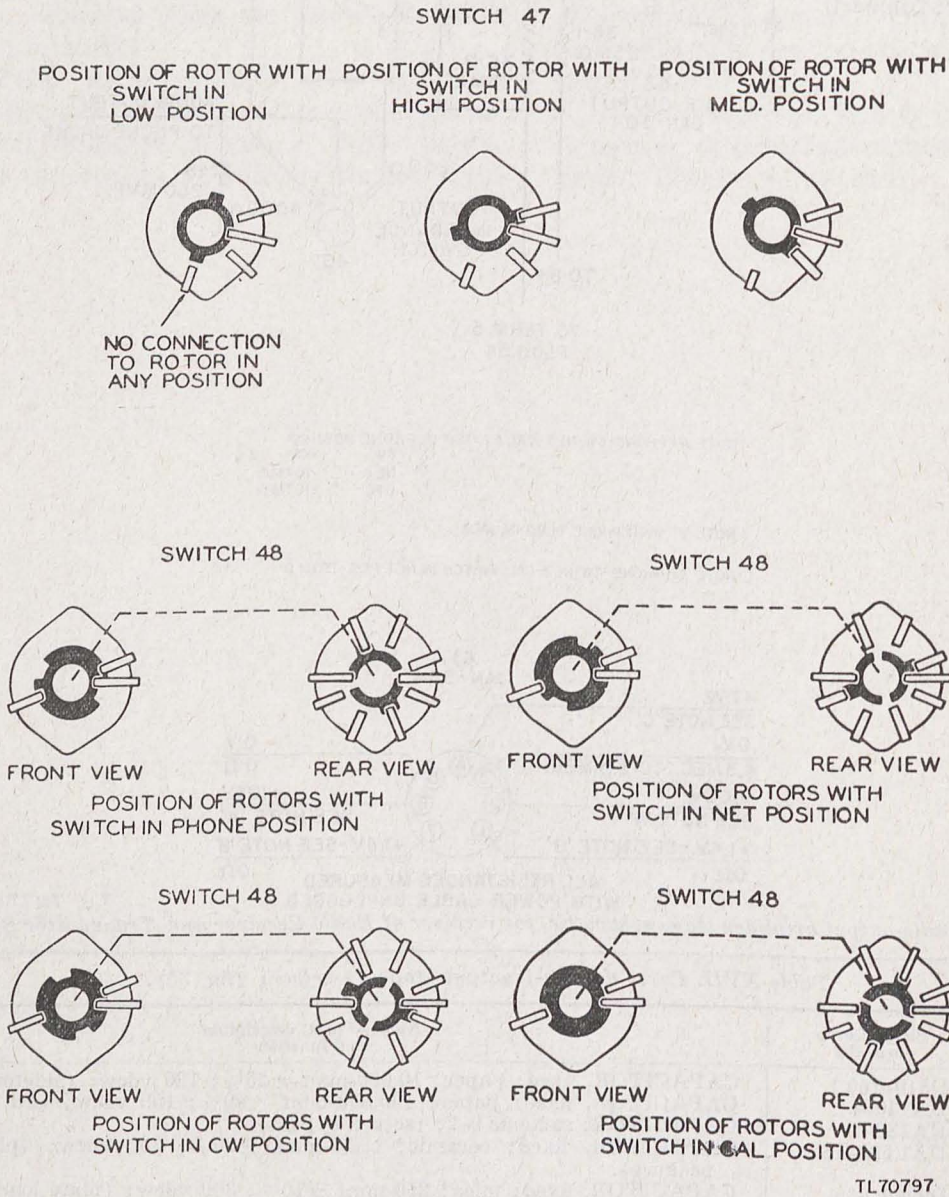
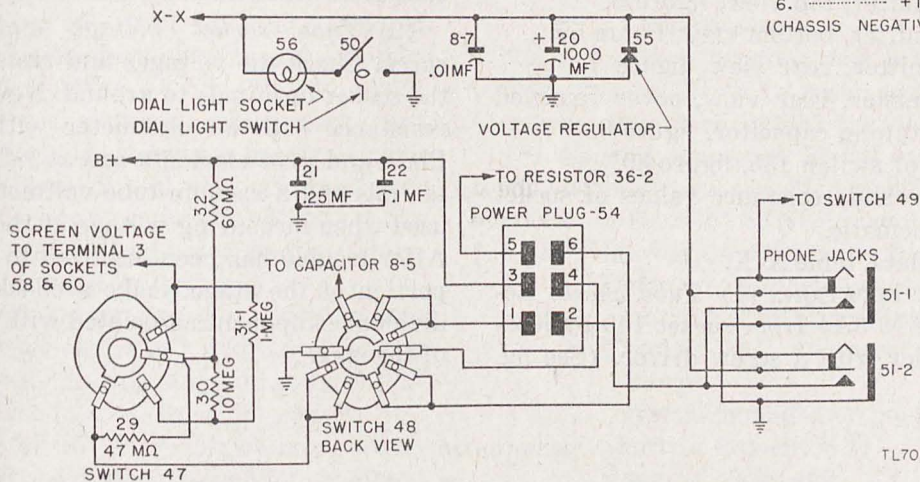

Figure 37. Details of switches 47 and 48 of receiver of Radio Receiver and Transmitter BC-1306.

- * WITH PHONE-CW-NET-CAL. SWITCH
IN NET OR CAL. POSITION.
△ WITH PHONE-CW-NET-CAL. SWITCH
IN PHONE OR CW POSITION.

POWER PLUG-54	
TERMINAL	VOLTAGE
1.	+105
2.	+1.4
3.	+105
4.	+105 *
5.	0
6.	+105 △

(CHASSIS NEGATIVE)



TL70800

Figure 38. Power and switching connections schematic for receiver of Radio Receiver and Transmitter BC-1306.

Table XVIII. Parts data, power, and switching circuits (receiver) (fig. 38).

Reference symbol	Signal Corps stock No.	Name of part, description and function
8-7	3D810-160.1	CAPACITOR, fixed: paper; 10,000-mmf $\pm 20\%$; 120 vdcw; (r-f bypass).
20	3DB1000-3	CAPACITOR, fixed: electrolytic; 1,000-mf $+50\%$, -20% ; 3 vdcw; (a-f bypass).
21	3DA250-88	CAPACITOR, fixed: paper; 250,000-mmf $\pm 20\%$; 200 vdcw; (B+ bypass).
22	3DA100-209	CAPACITOR, fixed: paper; 100,000-mmf $\pm 20\%$; 120 vdcw; (B+ bypass).
29*	3RC10AE473K	RESISTOR: carbon; 47,000-ohm $\pm 10\%$; $\frac{1}{3}$ -w; insulated; (sensitivity).
30	3RC10AE106K	RESISTOR: carbon; 10-meg $\pm 10\%$; $\frac{1}{3}$ -w; insulated; (sensitivity).
31-1	3RC10AE105K	RESISTOR: carbon; 1-meg $\pm 10\%$; $\frac{1}{3}$ -w; insulated; (sensitivity).
32	3Z6660-24	RESISTOR: carbon; 60,000-ohm $\pm 10\%$; $\frac{1}{3}$ -w; insulated; (sensitivity).
47	3Z9825-62.94	SWITCH: rotary; (sensitivity).
48	3Z9825-62.93	SWITCH: rotary; (PHONE-CW-NET-CAL).
50	3Z9824-42.1	SWITCH: pushbutton; (dial light).
51-1	2Z5598-7	JACK ASSEMBLY: (phone).
51-2	2Z5598-7	JACK ASSEMBLY: (phone).
54	2Z7227-2	PLUG: male; 6-pin; polarized; (power).
55	3H4858-6	RECTIFIER: selenium dry disk; 1.4 vdcw rating; (voltage regulator).
56		SOCKET: (dial light).

*Resistor 29 in equipments Serial No. 1-211 was 20,000 ohms. Change to value in this table.

35. Transmitter Oscillator Stage

a. STAGE DATA. (1) Oscillator stage schematic, figure 40.

(2) Parts identification illustrations.

(a) Transmitter, top view, figure 6.

(b) Transmitter, bottom view, figure 55.

(c) Transmitter, rear view, figure 7.

(d) Transmitter, rear view, cover removed from ganged tuning capacitor, figure 8.

(3) Detail of switch 135, figure 39.

(4) Voltage and resistance values of socket 140, stage schematic.

(5) Parts data, table XIX.

b. TROUBLE LOCATION. (1) *Tube check.* Remove Tube JAN-3A4 from socket 140 by loosening its holder with a screw driver. (See fig.

6.) Test the tube with a tube checker and replace with a new tube if necessary. In replacing the tube be sure it is firmly seated in its socket and reinstall its holder properly to prevent the tube from loosening in its socket.

(2) *Tube socket voltage and resistance check.* Check the voltages and resistances from the socket terminals to ground. Never check for resistance with an ohmmeter with power on. Plate and grid elements are at r-f and d-c potentials and a vacuum-tube voltmeter should be used when measuring voltage at these elements. After trouble has been localized to a particular portion of the stage, make a check of each individual component associated with that portion of the stage.

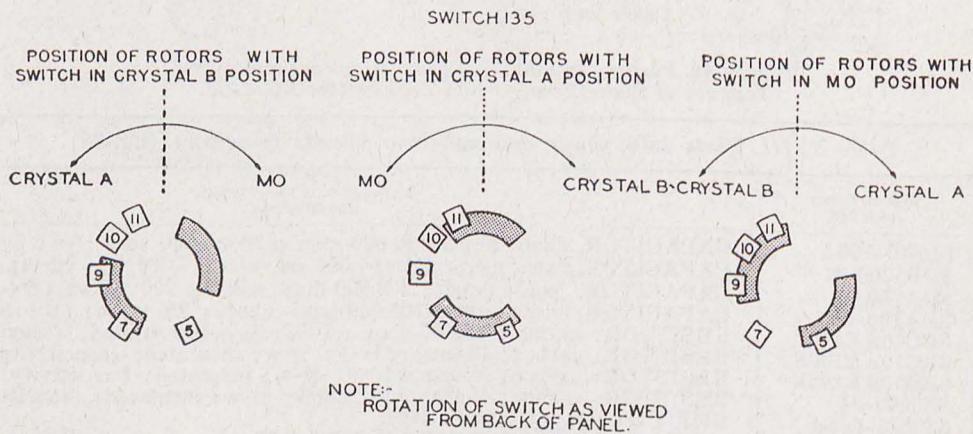

TL 51704-S

Figure 39. Detail of switch 135 for transmitter of Radio Receiver and Transmitter BC-1306.

(3) *Point-to-point continuity check.* If the preceding steps fail to indicate the cause of trouble, perform a point-to-point continuity check, referring to the stage schematic, figure 40, and to the parts identification illustrations, figures 6, 7, 8, and 55. Check for faulty soldered joints, broken leads, short circuits and grounds.

(4) *Over-all voltage checks.* Point-to-point voltage checks and voltages across component parts are performed referring to the normal voltage chart, figure 9. All voltages must conform with the values indicated. Data on the power supply voltages and associated switching connections is covered in figure 51.

(5) *Filament circuit.* (a) Excessive voltage across tube socket contacts 1 and 5 may be due to burned out tube in this stage or an open filament of the modulator tube in socket 141. Voltage regulator 157 may also be inoperative.

(b) Low voltage may be caused by run-down Battery BA-48, poor contacts at relay 156 (terminals 1 and 2), or defective contacts of switch 138.

(c) An open filament circuit may be due to an open resistor 122, an open r-f choke 128, one-half filament of Tube JAN-3A4 burned out, broken connections or faulty conditions as mentioned in (b) above.

(6) *Lack of oscillation.* (a) *MO operation.* If the oscillator does not oscillate in this position, the following conditions should be checked:

1. Low emission of Tube JAN-3A4.
2. Low-power supply source or run-down Battery BA-48.
3. Defective 105-volt circuit due to voltage regulator tube in socket 146, defective or out of socket.
4. Faulty contacts of switch 135 in MO position.
5. No plate voltage due to faulty power source, open resistor 106 or open r-f choke 130.

6. Defective grid leak resistor 105.
7. Shorted grid capacitor 79.
8. Shorted capacitors 75A, 76A, 76B, or 77 across coil 125.
9. Open circuit wiring or faulty soldered connections.

When a faulty connection has been localized, correct this condition to restore the oscillator to normal operation in MO position.

(b) *Crystal operation.* If the oscillator performs normally in the MO position, but abnormally in the CRYSTALS position of switch 135, the following conditions should be checked:

1. Defective contacts of switch 135 in crystal A or B position.
2. Crystals of incorrect frequency range.
3. Crystals damaged or poor oscillators.
4. Short in Capacitor 94.
5. Open r-f choke 129.

Substitute replacement crystals and correct the faulty condition to restore normal crystal operation.

(7) *R-f output.* If the r-f output is insufficient, the following conditions should be checked:

- (a) Low emission of Tube JAN-3A4 or one-half of its filament open.
- (b) Low power supply source voltage or run-down Battery BA-48.
- (c) Incorrect grid bias due to defective resistor 105 and/or capacitor 79.
- (d) Capacitor 94 leaking to ground.
- (e) R-f being shorted to ground in the output circuit due to grounded wiring or short circuit in the p-a grid circuit. When a faulty condition has been localized, it should be remedied to permit full r-f output from the oscillator stage.

c. REMOVAL AND REPLACEMENT OF GANGED TUNING CAPACITOR. Whenever it is necessary to remove this unit, see paragraph 40.

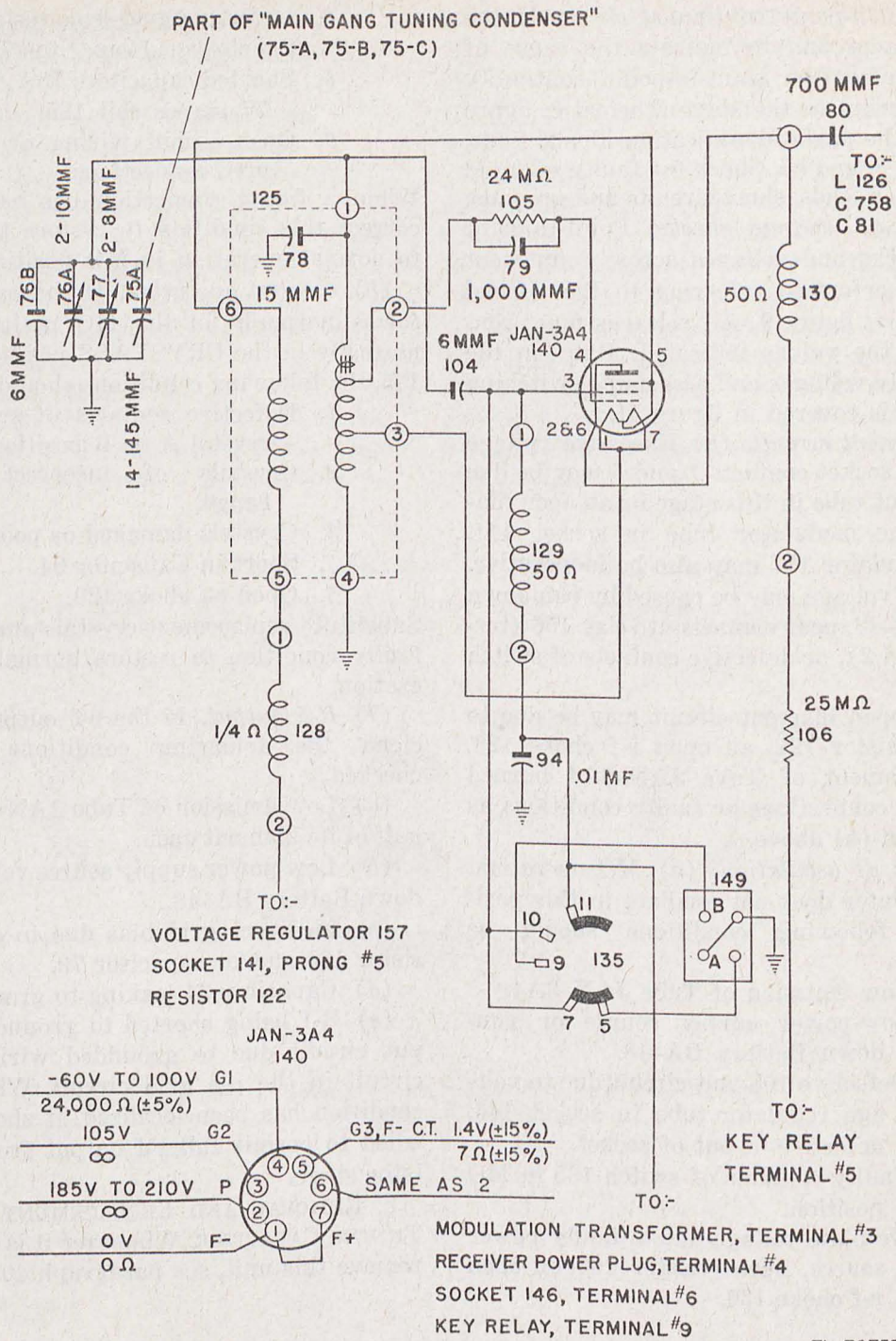

TL 70755

Figure 40. Oscillator stage schematic of transmitter of Radio Receiver and Transmitter BC-1306.

Table XIX. Parts data, transmitter oscillator stage (fig. 40).

Reference symbol	Signal Corps stock No.	Name of part, description and function
75-A	3D9145V-3	CAPACITOR, variable: air; 14-mmf min, 145-mmf max (section 1 of 3); (part ganged tuning capacitor resonates coil 125).
76-A	3D9010V-6	CAPACITOR, variable: air; 2-mmf min, 10-mmf max; (fine tuning of coil 125).
76-B		CAPACITOR, fixed: ceramic; 6-mmf $\pm 10\%$; (temperature compensator across coil 125).
77	3D9008V-6	CAPACITOR, variable: air; 2-mmf min, 8-mmf max; (CAL tuning of coil 125).
78	3D9015-26	CAPACITOR, fixed: ceramic; 15-mmf $\pm 5\%$; (neg coefficient compensator, coil 125).
79	3D9500-18	CAPACITOR, fixed: mica; 500-mmf $\pm 10\%$; 500 vdcw; (grid-leak charge).
80		CAPACITOR, fixed: mica; 700-mmf $\pm 10\%$; 500 vdcw; (r-f cplg to coil 126).
94	3DA10-160.1	CAPACITOR, fixed: paper; 10,000-mmf $\pm 20\%$; 120 vdcw; (screen-grid r-f bypass to ground).
104	3D9006-10	CAPACITOR, fixed: ceramic; 6-mmf $\pm 5\%$; 500 vdcw; (neutralizing; prevents self-oscillation).
125	2C5395-1306/C11	COIL ASSEMBLY: (osc grid coil, to resonant freq).
128	3C323-34B	COIL: r-f choke; 30-mh; (blocks r-f from fil circuit).
129	2C5395-1306/C5	COIL: r-f choke; 3-mh; (high impedance to r-f current using crystal operation).
130	2C5395-1306/C1	COIL: r-f choke; 3-mh; (blocks r-f from power supply).
105	3Z6624-3	RESISTOR: carbon; $\frac{1}{2}$ -w; 24,000-ohm $\pm 5\%$; insulated; (grid-leak bias).
106	3Z6625-59	RESISTOR: fixed; wire-wound; 25,000-ohm $\pm 10\%$; 10-w; (plate voltage dropping resistor).
140	2Z8677.36	SOCKET: tube; miniature; 7-prong; (Tube JAN-3A4).
149	2Z8678	SOCKET: 4-prong; (crystal holder).
135	3Z9825-62.81	SWITCH: rotary; selector; single-section; 3-position; (MO-CRYSTALS selector).
		TUBE JAN-3A4: (r-f generator).

36. Transmitter P-A Stage

a. STAGE DATA. (1) P-a stage schematic, figure 41.

(2) Parts identification illustrations.

(a) Transmitter, top view, figure 6.

(b) Transmitter, rear view, figure 7.

(c) Transmitter, bottom view, figure 55.

(d) Transmitter, rear view, cover removed from ganged tuning capacitor, figure 8.

(e) Transmitter, rear view, less ganged tuning capacitor and cover, figure 10.

(3) Voltage and resistance values of socket 142, stage schematic, figure 41.

(4) Parts data, table XX.

b. TROUBLE LOCATION. (1) *Tube check.* Remove Tube JAN-2E22, socket 142, by removing the plate cap lead and loosening the clamping ring at the tube base. (See fig. 7.) Test tube with a tube checker and replace with a new tube if necessary. When replacing a tube, make sure it is firmly seated in its socket, the clamping ring is securely locked, and the plate cap lead is restored.

Warning: When transmitter is in operation there are 500 volts d-c, plus high r-f voltage on the plate cap.

(2) *Tube socket voltage and resistance check.* Voltages and resistances are checked from the tube socket terminals to ground. Never check for resistance with the power on. Plate and grid elements are at high r-f and d-c potentials. Use a vacuum-tube voltmeter when measuring voltage at these elements, exercising extreme care to avoid bodily contact while the power is on. After trouble has been localized to a particular portion of the stage, make a check of each individual component associated with that portion of the stage and correct the fault.

(3) *Point-to-point continuity check.* If the preceding steps fail to indicate the cause of trouble, perform a point-to-point continuity check, referring to the stage schematic, figure 41, and to the parts identification illustrations, figures 6, 7, 8, and 55. Check also for faulty soldered joints and defective wiring.

(4) *Over-all voltage checks.* Point-to-point voltage checks across component parts are performed referring to the normal voltage chart, figure 9, and must conform to the values indicated. All voltages depend on the position of switches 136, 137, and 138. Refer to data on power supply voltages and associated switching connections as covered on figure 51.

(5) *Metering socket 143.* Test all voltages at

this socket (fig. 7), referring to paragraph 39, table XXIII, for values and switching positions.

(6) *R-f checks.* Probe for r-f with a neon lamp, exercising care to avoid bodily contact with high potentials. An a-c vacuum-tube voltmeter may also be used for checking r-f potentials.

(7) *Lack of r-f at input circuit.* If there is no indication of r-f in the grid circuit, the following conditions should be checked:

(a) Test for r-f with a neon lamp or an a-c vacuum-tube voltmeter at contact 3 of tube socket 142. A weak glow, or no glow, indicates poor or no r-f excitation from the oscillator stage.

(b) Check for r-f at each side of capacitor 80, coil 126 (terminal 1), stator plates of capacitor 75B and trimmer 81.

(c) Failure to secure r-f at all of these points indicates the oscillator stage is inoperative and should be corrected accordingly.

(d) With normal oscillator r-f output, loss of r-f at contact 3 indicates an open capacitor 80, an open coil 126, or open circuit wiring. Localize where r-f is lost and correct the fault.

(e) Low oscillator r-f output will cause low d-c bias voltage due to lack of sufficient r-f excitation. The negative grid voltage must be between negative 47 and negative 68 volts for normal operation. If resistors 107 and 109 are open, or capacitors 82 or 83 are shorted, the grid circuit will be unbiased causing excessive plate current being drawn as indicated by a red hot plate of Tube JAN-2E22.

Warning: Failure to turn power off at once when plate of Tube JAN-2E22 is red, will cause damage to the tube and an overload on other circuit components.

(8) *Lack of r-f at output circuit.* If r-f output is low in the plate circuit, check for the following:

(a) Open-circuited capacitor 101.

(b) Open-circuited capacitor 87.

(c) Shorted capacitor 102.

(d) Shorted or grounded turns in coil 127.

(9) *Tank circuits.* Coils 126 and 127 should show continuity and freedom from grounds. Look for shorted turns. Tuning capacitors across each tank circuit must show infinity resistance checks. Rotate the frequency dial throughout its range during these checks. Look for bent plates and correct accordingly.

(10) *Lack of modulation or sidetone output.* These are generally covered under modulator

stage data, paragraph 38b(5). If difficulties are encountered in the p-a stage, check for the following:

(a) Improper values of negative voltage in the MCW-PHONE position of switch 136 may be caused by open resistor 108, shorted capacitor 83, or poor contact connections on switch 136.

(b) Defective or open resistor 110, will allow floating or unstabilized operation of the suppressor grid circuit.

(c) Open or defective resistor 118 will show up by unequalization of sidetone level between CW and MCW positions of switch 136.

(d) Open or defective resistor 119 will unload the suppressor grid in the MCW position.

(e) Open capacitor 84 will allow r-f leakage on to the audio-frequency modulation causing fuzziness of speech.

(f) Shorted capacitor 84 will short circuit the a-f to ground, resulting in no modulation in the MCW-PHONE position of switch 136. When the faulty condition has been localized,

correct the condition to restore normal operation.

c. REMOVAL AND REPLACEMENT OF GANGED TUNING CAPACITOR. Whenever it is necessary to remove this unit, refer to detailed procedure as covered in paragraph 40.

d. REMOVAL AND REPLACEMENT OF TRANSMITTER DIAL LIGHT. (1) Remove receiver from case (release two retainer clamps on each side of the case, see fig. 1) and remove DIAL LIGHT EXTRACTOR mounted on the inside of the case. (See fig. 4.)

(2) Remove four screws, item 4, holding dial window frame and gasket to the panel. (See fig. 25.)

(3) Press the rubber end of the extractor over the dial light and unscrew defective bulb. Install new dial light in reverse procedure, securely screwing bulb into the socket.

(4) Replace gasket and window frame, securely making up all four screws so as to be waterproof.

(5) Restore extractor and receiver in case.

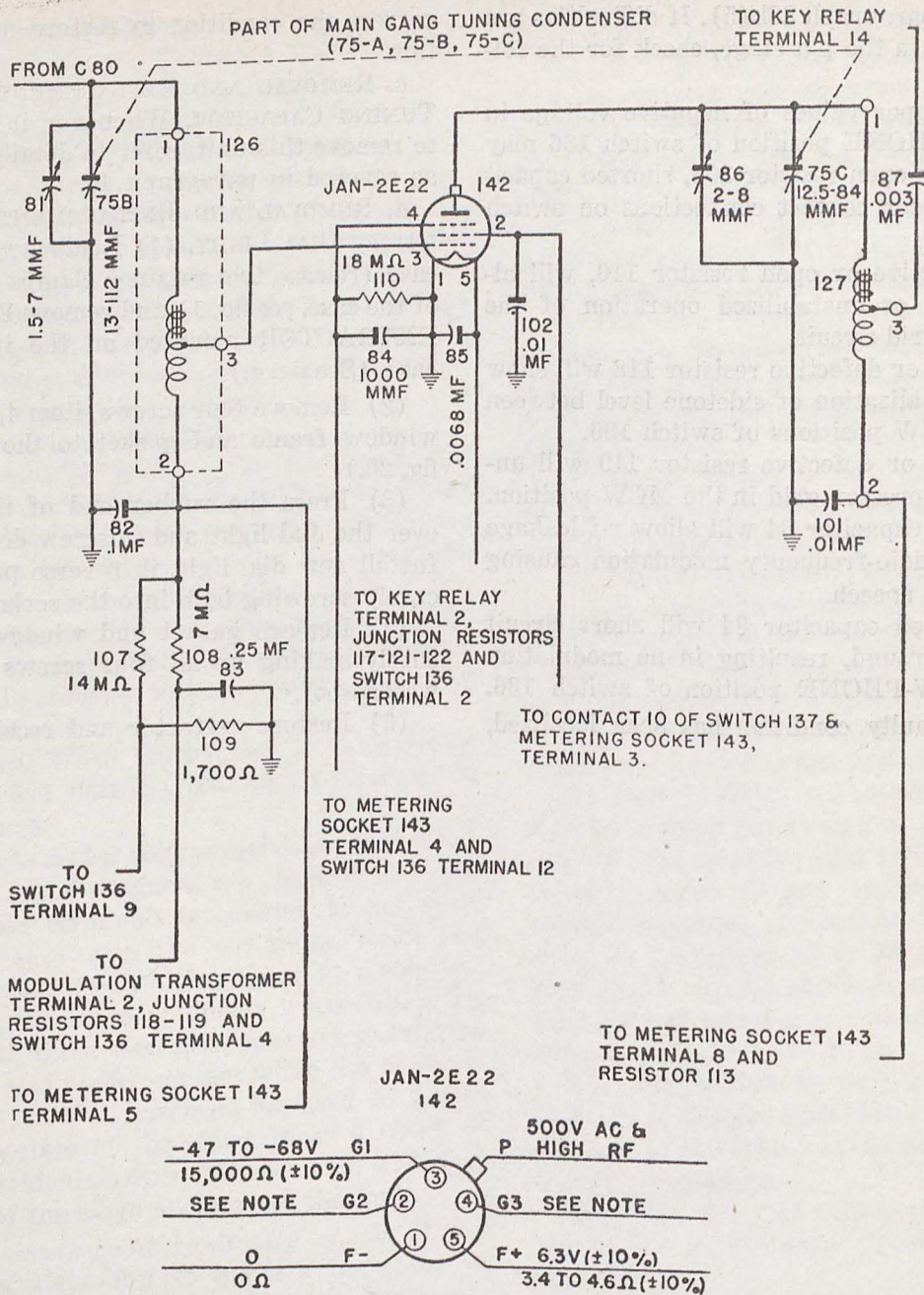

Figure 41. P-a stage schematic for transmitter of Radio Receiver and Transmitter BC-1306.

Table XX. Parts data, power amplifier (transmitter) (fig. 41).

Reference symbol	Signal Corps stock No.	Name of part, description and function
75-B	3D914V-3	CAPACITOR, variable: air; 13-mm ² min, 112-mm ² max (sec 2 of 3); (part of ganged tuning-to resonate coil 126).
75-C	3D9145V-3	CAPACITOR, variable: air; 12.5-mm ² min, 84-mm ² max (sec 3 of 3); (part of ganged tuning-to resonate coil 127).
81	3D9001VE5-1	CAPACITOR, variable: ceramic; 1.5-mm ² min, 7-mm ² max; (doubler trimmer; fine tuning of coil 126).
82	3DA100-209.1	CAPACITOR, fixed: paper; 100,000-mm ² $\pm 10\%$; 120 vdcw; (p-a grid return r-f bypass).
83	3DA250-88	CAPACITOR, oil: paper; 0.25-mf; (suppressor-grid audio bypass).
84	3DA1-123	CAPACITOR, fixed: ceramic; 1,000-mm ² $\pm 10\%$; 500 vdcw; (suppressor bypass).
85	3DA6.800-2	CAPACITOR, fixed: ceramic; 6,800-mm ² $+30\%$, -20% ; 300 vdcw; (filament r-f bypass).
86	3DA9015V-19	CAPACITOR, variable: air; 2-mm ² min, 7-mm ² max; 4,000-v peak; (p-a trimmer-fine tuning of coil 127).
87	3DA3-5	CAPACITOR, fixed: mica; 3,000-mm ² $\pm 10\%$; 750 vdcw; (r-f cplg to antenna network via key relay).
101	3DA10-126.1	CAPACITOR, fixed: paper; 10,000-mm ² $\pm 10\%$; 1,000 vdcw; (plate supply r-f bypass).
102	3DA10-124.1	CAPACITOR, fixed: paper; 10,000-mm ² $\pm 20\%$; 600 vdcw; (screen-grid r-f bypass).
126	2C5395-1306/C8	COIL: r-f doubler grid; (resonated to twice oscillator frequency).
127	2C5395-1306/C10	COIL: r-f p-a plate; (resonated to output frequency).
107	3Z6614-5	RESISTOR: fixed; carbon; 14,000-ohm $\pm 10\%$; 1-w; (grid-leak).
108	3Z6570-19	RESISTOR: fixed; carbon; 7,000-ohm $\pm 10\%$; $\frac{1}{2}$ -w; (part of suppressor-grid bias voltage divider).
109	3Z6170-4	RESISTOR: fixed; carbon; 1,700-ohm $\pm 10\%$; $\frac{1}{2}$ -w; (modulator bias).
110	3RC21BE183K	RESISTOR: fixed; carbon; 18,000-ohm $\pm 10\%$; $\frac{1}{2}$ -w; (suppressor-grid return).
142	2Z8675.46	SOCKET: 5-prong; p-a tube; (Tube JAN-2E22).

37. Transmitter Antenna-tuning Network Stage

a. STAGE DATA. (1) Antenna-tuning network stage schematic, figure 42.

(2) Parts identification illustrations.

(a) Transmitter, top view, figure 6.

(b) Transmitter, rear view, figure 7.

(3) Parts data, table XXI.

b. TROUBLE LOCATION. (1) *Circuit theory.* The r-f output of the transmitter is designed to operate with either a short whip antenna or a one-half wavelength antenna, AN-160. Switch 139 selects the proper circuit constants for the type of antenna in use and connects the r-f output to antenna POST 158. Positions 1, 2, and 3 of switch 139, select the proper value of loading inductance, coil 124, for whip antenna operation, and positions 4, 5, and 6, of switch 139, select the proper value of loading capacitors 91, 92, and 93 when antenna AN-160 is used. Critical resonance of the transmitter frequency to

the antenna in use is accomplished by varying the coupling of tuning coil 131 until maximum brilliance is indicated on the neon bulb in socket 152.

(2) *Point-to-point r-f check.* A neon bulb lamp is used for point-to-point r-f tracing, to find the place where r-f was last located. If r-f output is not secured at antenna post 158, when key relay 156 is in the SEND position, check the following items:

(a) Poor contacts on relay 156, springs 14 and 15.

(b) Defective neon lamp in socket 152.

(c) Shorted or grounded socket 152.

(d) Open antenna tuning coil 131.

(e) Open antenna loading coil 124.

(f) Defective capacitors 91, 92, and 93.

(g) Grounded antenna post 158.

Replace the defective part and repair unsoldered connections for broken leads, whenever necessary, to restore normal operation.

Table XXI. Parts data, antenna network (transmitter) (fig. 42).

Reference symbol	Signal Corps stock No.	Name of part, description and function
88		CAPACITANCE of socket 152; (neon lamp to ground).
91	3D9090-9	CAPACITOR, fixed: ceramic; 90-mmf $\pm 5\%$; 3,800 v a-c test; (antenna loading).
92	3D9115	CAPACITOR, fixed: ceramic; 115-mmf $\pm 5\%$; 3,800 v a-c test; (antenna loading).
93	3D9135-6	CAPACITOR, fixed: ceramic; 135-mmf $\pm 5\%$; 3,800 v a-c test; (antenna loading).
124	2C5395-1306/C9	COIL: antenna; r-f loading; (to resonate antenna).
131	2C5395-1306/C4	COIL: r-f; antenna tuning; (resonate ant to transmitter operating frequency).
159		INDICATOR: polaroid; (shades brilliance of neon bulb socket 152).
158	3Z774-5.1	POST: antenna binding; (r-f output to antenna).
152	2Z5885-8	SOCKET: assembly; candelabra; bayonet; (for neon bulb).
139	3Z9825-62.85	SWITCH: rotary; single-section; 6-position; ceramic; insulation; (antenna selector of proper circuit constants).
		NEON BULB: bayonet base; $\frac{1}{4}$ -w; (r-f output indicator).

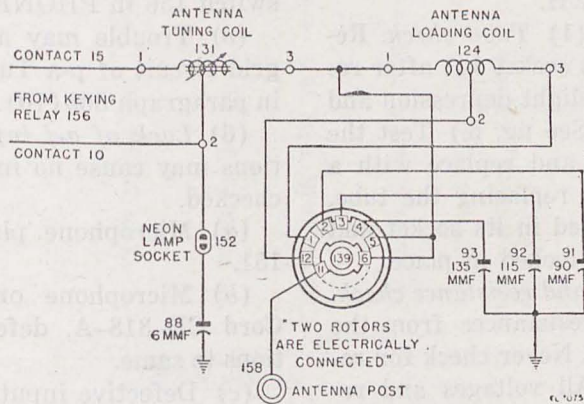

Figure 42. Antenna tuning network stage schematic of transmitter of Radio Receiver and Transmitter BC-1306.

38. Transmitter Modulator Stage

a. STAGE DATA. (1) The modulator stage schematic, figure 43.

(2) Parts identification illustrations.

(a) Transmitter, top view, figure 6.

(b) Transmitter, bottom view, figure 55.

(c) Transmitter, rear view, figure 7.

(d) Transmitter, rear view, cover removed from ganged tuning capacitor, figure 8.

(e) Transmitter, rear view, less ganged tuning capacitor and cover, figure 10.

(3) Voltage and resistance values of socket 141, stage schematic, figure 43.

(4) Parts data, table XXII.

b. TROUBLE LOCATION. (1) *Tube check.* Remove Tube JAN-3A4 from socket 141 after removing its tube shield by slight depression and short turn to the right. (See fig. 6.) Test the tube with a tube checker and replace with a new tube if necessary. In replacing the tube, make sure it is firmly seated in its socket and the tube shield is securely locked in place.

(2) *Tube socket voltage and resistance check.* Check the voltages and resistances from the socket terminals to ground. Never check for resistance with power on. All voltages and resistances must be normal as indicated on figure 43. Localize any trouble to a particular portion of the stage, making a check of each individual component associated with that portion of the stage.

(3) *Point-to-point continuity check.* If the preceding steps fail to indicate the cause of trouble, perform a point-to-point continuity check, referring to the stage schematic, figure 43, and to the parts identification illustrations, figures 6, 7, 8, and 55. Check the voltage drop across the resistors, transformers, and other components. Check for faulty soldered joints, broken connections, short circuits, and grounds.

(4) *Over-all voltage checks.* Point-to-point voltage checks and voltages across component parts are performed referring to the normal voltage chart, figure 9. All voltages must conform with the values indicated thereon. Data on the power supply voltages and associated switching connections is covered in figure 51.

(5) *Lack of modulation.* Conditions causing lack of modulation may be traced to the following items and should be checked accordingly.

(a) Tube JAN-3A4 in socket 141 may be low in emission, defective, one-half filament open, or burned out.

(b) Modulation transformer 133 may be defective, being open or having shorted turns, or

grounded secondary winding. Replacement of this transformer should be made if any of these defects show up.

(c) Defective screen grid circuit caused by defective contacts of switch 138, open resistor 114, run-down Battery BA-48, defective voltage regulator tube in socket 146, shorted capacitor 95; or faulty connection between receiver control to plug 54 (on receiver), receptacles 175 and 66 (on case), and receiver power plug 148 (on transmitter). (See fig. 16.) Localize the trouble and correct the fault.

(d) Defective contacts or open circuit at switch 136 in PHONE position.

(e) Trouble may also be in the suppressor grid circuit of p-a Tube JAN-2E22 as covered in paragraph 36b(10).

(6) *Lack of a-f input.* The following conditions may cause no input signal and should be checked.

(a) Microphone plug not inserted in jack 151.

(b) Microphone or microphone switch of Cord CD-318-A, defective or broken connections to same.

(c) Defective input transformer 132 having open primary or secondary.

(d) No polarizing voltage available for microphone due to defective contacts at switch 138 in SEND position, or open resistor 117.

(e) Shorted capacitor 97.

(f) Open resistor 120.

(7) *Low a-f output.* Conditions causing low a-f output may be traced to the following items:

(a) Tube JAN-3A4, socket 141, low in emission or having one-half filament open.

(b) Defective resistor 120.

(c) Defective screen grid circuit as covered in (5)(c) above.

(8) *Lack of sidetone signal.* Failure to receive sidetone signal output may be traced to the following conditions:

(a) Potentiometer 115 (fig. 25) not set properly or may open.

(b) Capacitor 96 open or defective.

(c) Defective wiring and poor plug or receptacle contacts in plug 148 (on transmitter), receptacles 66 and 175 (in case), and plug 54 (on receiver). See case wiring diagram, figure 16.

(d) Defective switch 136, figure 49, or poor contacts in CW-MCW position.

(e) Poor contacts on keying relay 156.

(f) Switch 48 on receiver may be in NET or CAL position.

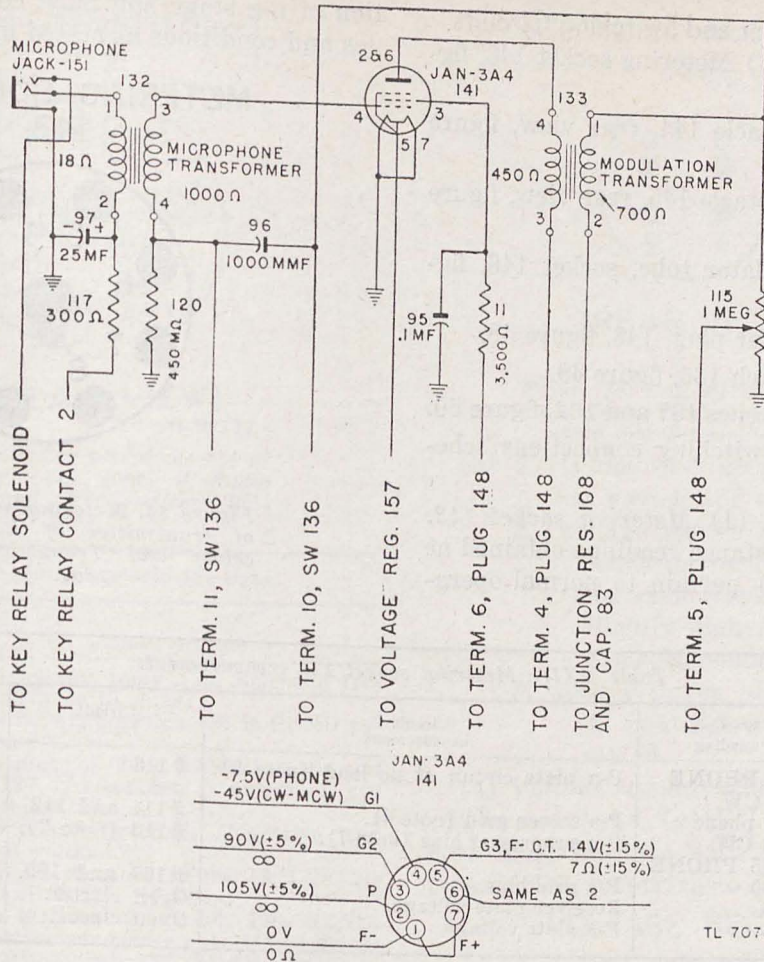

Figure 43. Modulator stage schematic of transmitter of Radio Receiver and Transmitter BC-1306.

Table XXII. Parts data, modulator stage (transmitter) (fig. 43)

Reference symbol	Signal Corps stock No.	Name of part, description and function
95	3DA100-209	CAPACITOR, fixed: paper; 100,000-mmf ±20%; 120 vdcw; (screen-grid bypass).
96	3DA1-123	CAPACITOR, fixed: ceramic; 1,000-mmf ±20%; 500 vdcw; (feedback for sidetone circuit).
97	3DB25-34	CAPACITOR, fixed: electrolytic; 25-mf ±100%, -10%; 25 vdcw; (microphone filter bypass).
114	3Z6350-31	RESISTOR: fixed; carbon; 3,500-ohm ±10%; ½-w; (screen-grid dropping).
115	3Z6801-17	RESISTOR: potentiometer; 1-meg ±20%; (sidetone output to revr).
117	3Z6030-76	RESISTOR: fixed; carbon; 300-ohm ±20%; ½-w; (microphone decoupling filter).
120		RESISTOR: fixed; carbon; 450,000-ohm ±10%; ½-w; (grid-leak bias).
141	2Z8677.37	SOCKET: tube; miniature; 7-prong; (modulator, Tube JAN-3A4).
132	2Z9631.95	TRANSFORMER: input, a-f microphone; (steps up microphone volume).
133	2Z9634.39	TRANSFORMER: modulation; (a-f; modulates suppressor-grid of Tube JAN-2E22).
		TUBE JAN-3A4: (modulator).

39. Transmitter Power and Switching Circuits

a. STAGE DATA. (1) Metering socket 143, figure 44.

(2) Power receptacle 144, rear view, figure 45.

(3) Battery receptacle 145, rear view, figure 46.

(4) Voltage regulator tube, socket 146, figure 47.

(5) Receiver power plug, 148, figure 48.

(6) Detail of switch 136, figure 49.

(7) Detail of switches 137 and 138, figure 50.

(8) Power and switching connections schematic, figure 51.

b. SERVICE DATA. (1) *Metering socket 143.* All voltage and resistance readings obtained at this socket (fig. 44) pertain to normal opera-

tion of p-a stage and must conform to the values and conditions as stated under table XXIII.

METERING SOCKET 143

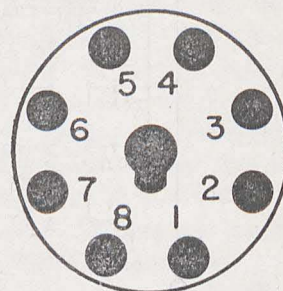

TL70775

Figure 44. Metering socket 143 of transmitter of Radio Receiver and Transmitter BC-1306.

Table XXIII. Metering socket 143 measurements.

Prong	Prong	Voltage reading	Circuit measurement	Circuit resistor	Resistance measurement
2 (+)	8 (—)	.05 PHONE .14 CW	P-a plate circuit at no load (note 5).	#113	20 ohms $\pm 5\%$.
3 (+)	7 (—)	180 phone	P-a screen grid (note 6).	#111 and 112.	See note 6.
4 (—)	7 (+)	+6 CW —45 PHONE	P-a suppressor bias (note 7).	#110 (note 7).	18,000 ohms $\pm 10\%$.
5 (—)	7 (+)	—60	P-a grid bias.	#107 and 109.	15,700 ohms $\pm 10\%$.
6 (+)	7 (—)	105	Receiver plate voltage.	Open circuit.	See warning.
8 (+)	7 (—)	500	P-a plate voltage.	Open circuit.	See warning.

Warning: Meter leads dangerous when power is on. Exercise all safety precautions while making voltage readings.

- Notes
- All readings with power switch 137 in HIGH.
 - All readings with reference to prong 7 (ground).
 - D-c voltmeter, 1,000-ohms per volt, used for all voltage measurements.
 - Ohmmeter set at scale nearest to the resistance reading. Do not use with power on.
 - Current in milliamperes equals voltage times 50.
 - Depends on position of switch 137, for example:

Position	Voltage	Resistance measurement
HIGH	180 v (± 35 v)	#111 and 112 in parallel; 10,000 ohms $\pm 5\%$.
MEDIUM	150 v (± 25 v)	112 only in circuit; 20,000 ohms $\pm 5\%$.
LOW	100 v (± 15 v)	111 and 112 in series; 40,000 ohms $\pm 10\%$.

7. Depends upon position of switch 136, for example:

Position	Voltage	Resistance measurement
CW	+6 v	10,000 ohms $\pm 10\%$.
MCW-PHONE	—40 v	3 to 4 ohms.

(2) *Power receptacle 144, rear view.* All voltage readings obtained at this receptacle must conform to the values specified in table XXIV, for normal voltage supply sources.

POWER RECEPTACLE 144

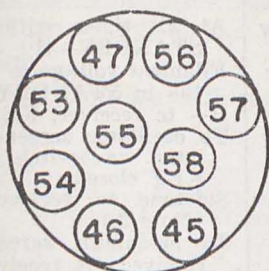

(REAR VIEW)

TL70777

Figure 45. Power receptacle 144 of transmitter, rear view, of Radio Receiver and Transmitter BC-1306.

Table XXIV. Power receptacle 144 data.

Prong	Voltage reading	Circuit reference
45	6.0	To keying relay 156. Solenoid (resistance 13 ohms).
46	1.4	To receiver, switch 138 in SEND position.
47	500.	To plate of Tube JAN-2E22 via coil 127. To contacts 3 and 6 of key relay 156.
53	0	To chassis ground. (Negative lead of voltmeter.)
54	6.0	To p-a filament (Tube JAN-2E22), switch 138, SEND.
55	0	To terminal 3, switch 138, SEND.
56	1.4	To receiver power plug 143, terminal #2, switch 138, STANDBY.
57	105.0	To oscillator screen, modulator plate and receiver, switch 138, SEND.
58	105.0	To oscillator screen, modulator plate and receiver, switch 138, STANDBY.

Warning: All voltage readings taken with power on. Exercise extreme care! High voltages are dangerous.

- Notes 1. Temporarily remove metering socket 143 and cover to take voltage checks; upon completion of all checks, remount socket 143 and cover in position.
2. Above voltages taken with 1,000-ohm-per-volt voltmeter. Readings will be higher if more sensitive voltmeter is used.

(3) **Battery receptacle 145, rear view.** (a) **Voltage checks.** All voltages must conform with values as stated in table XXV for normal voltages of Battery BA-48, referring to figure 46.

Table XXV. Battery receptacle 145 data.

Prong	Voltage	Measurement
A	+1.4 v	To receiver with switch 138 at STANDBY.
D	+105 v	To receiver plates; to oscillator screen and modulator plate, when switch 138 is at STANDBY.
C	Neg	Common negative.
D	0	Chassis ground.

BATTERY RECEPTACLE 145

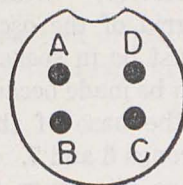

(REAR VIEW)

TL70779

Figure 46. Battery receptacle 145 of transmitter, rear view, of Radio Receiver and Transmitter BC-1306.

(b) **Tests and conditions.**

- Set switch 138 at STANDBY.
- Voltage checks taken at the female connector of Cord CD-1119 are of the same polarity but may be of a slightly higher voltage due to the unloaded condition.
- Low voltages indicate Battery BA-48 is run-down and should be replaced.

(4) **Voltage regulator Tube JAN-OC-3/VR-105 in socket 146.** (a) **Voltage checks.** All voltages must conform with the values stated in table XXVI, referring to figure 47.

VOLTAGE REGULATOR TUBE SOCKET 146

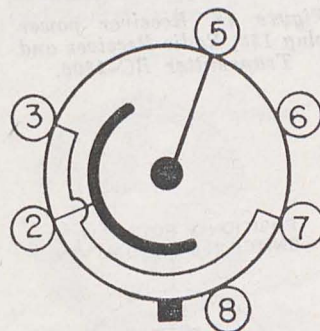

TL70781

Figure 47. Voltage regulator Tube JAN-OC-3/VR-105 in socket 146, BC-1306 Transmitter of Radio Receiver and Transmitter BC-1306.

Table XXVI. Voltage regulator tube data.

Prong	Voltage	Measurement
2	0 (-)	Cathode element of tube is grounded. At all times when switch 138 is at STANDBY or SEND.
3	105 v	
5 and 7	105 v	Plate element of tube. Voltage only if tube is in socket 146. When KEY is closed. When solenoid of key relay 156 is energized, KEY closed.
6	105 v	
8	6 v	

(b) *Tests and conditions.*

1. This tube regulates the B voltage to the receiver, modulator, and screen-grid of the oscillator.
2. A tube must be in socket 146 before tests can be made because a jumper within the base of the tube connects prongs 3 and 7.
3. Low voltage at prongs 5 or 7 indicates a faulty tube. Replace with new tube.

(5) *Receiver power plug 148.* (a) *Voltage checks.* All voltage and resistance readings obtained at this plug must conform with values shown in table XXVII, referring to figure 48.

RECEIVER POWER PLUG 148

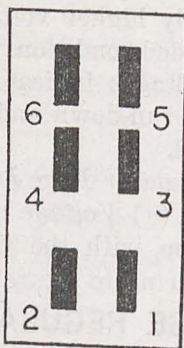

TL70780

Figure 48. Receiver power plug 148, Radio Receiver and Transmitter BC-1306.

Table XXVII. Receiver power plug 148 data.

Prong	Voltage	Measurement and condition
1	105 v	At all times with switch 138 in STANDBY—B+ to receiver.
2	1.4 v	Filament voltage to receiver—switch 138 in STANDBY.
3	105 v	B+ to receiver, KEY open.
4	105 v	To oscillator screen-grid and modulator via switch 48 on receiver, KEY closed.
5	none	Sidetone to receiver (from 115). (Note 3.)
6	none	To modulator screen-grid. Voltage received via receiver switch 48 in CAL position.

(b) *Tests and conditions.*

1. Negative lead of voltmeter to chassis and positive lead to prong under test.
2. Do not check for resistance with the power on.
3. Resistance between prong 5 and ground will depend on the position of arm of potentiometer 115, figure 25. No reading on the ohmmeter indicates item 115 is open or open circuit wiring resulting in no sidetone signal being available.

(6) *Detail of switch 136.* (a) Switch 136 changes the p-a suppressor grid bias when switching from CW to MCW or PHONE. (See table XXIII, note 7.)

(b) The position of the rotors of this switch viewed from rear of panel at the CW-MCW-PHONE settings are shown on figure 49.

SWITCH 136

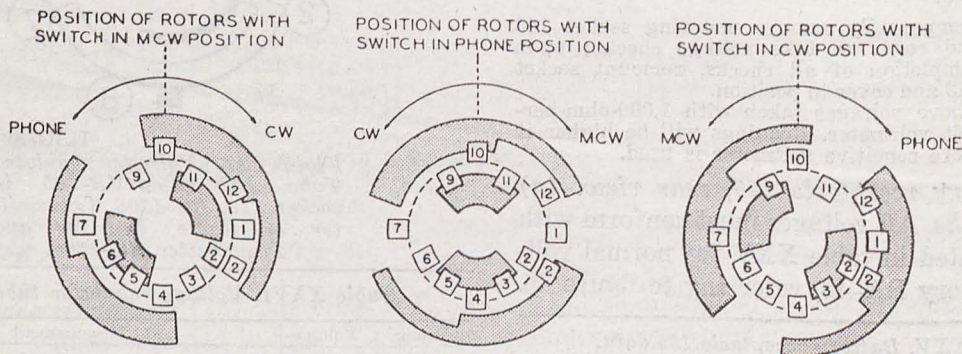

- NOTE 1:-
ROTATION OF SWITCH AS VIEWED
FROM BACK OF PANEL
- NOTE 2:-
NO. 4 LUG HAS NO CONNECTION
TO ROTORS. USED AS TIE LUG
FOR RESISTOR I18 ONLY

TL 70769

Figure 49. Detail of switch 136 of Transmitter of Radio Receiver and Transmitter BC-1306.

(c) Connections to other circuit components with this switch in the CW position are shown on figure 51.

(d) The over-all transmitter schematic (fig. 57), shows the connection of this switch in the PHONE position.

(7) Detail of switches 137 and 138. (a)

LOW positions are shown on figure 50.

(e) Connections to other circuit components with switch 137 at HIGH are shown in figures 51 and 57.

(d) The position of the rotors of switch 138 (viewed from the rear) at the SEND-STAND-

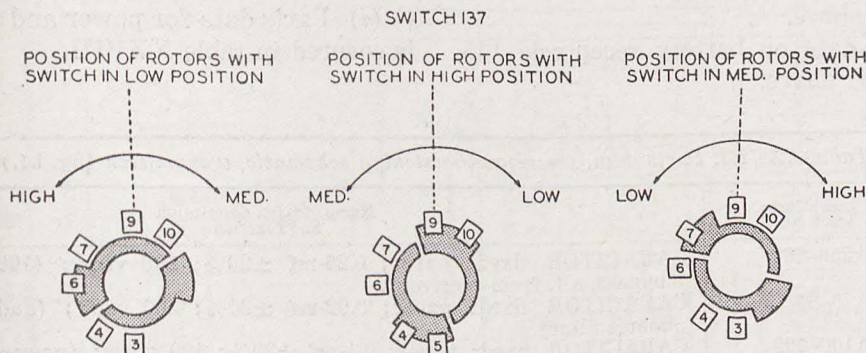

NOTE:-
ROTATION OF SWITCH AS VIEWED FROM BACK OF PANEL.

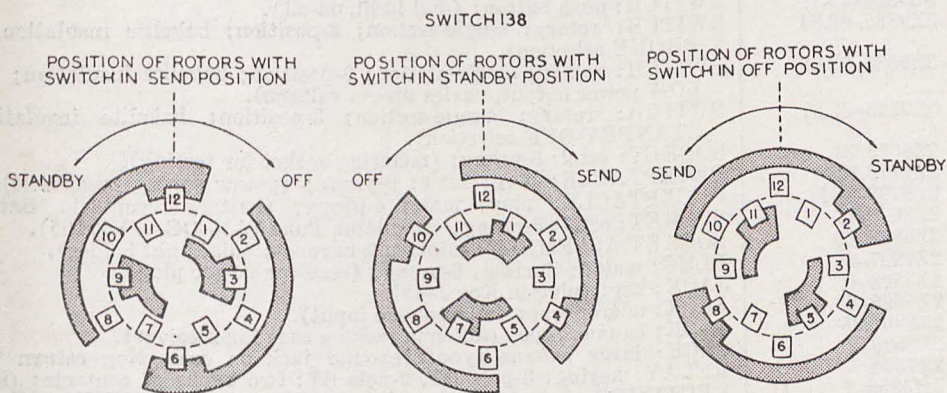

NOTE:-
ROTATION OF SWITCH AS VIEWED FROM BACK OF PANEL.

TL 70770

Figure 50. Detail of switches 137 and 138 of transmitter of Radio Receiver and Transmitter BC-1306.

Switch 137 controls the r-f power output by varying the p-a screen grid voltage. (See table XXIII, note 6.)

(b) The positions of the rotors of switch 137 (viewed from the rear) at the HIGH-MED.-

BY-OFF positions are shown in figure 50.

(e) Connection to other circuit components with switch 138 set at SEND are shown in figure 51.

(f) The over-all transmitter schematic (fig.

57) shows connections of switch 138 in the STANDBY position.

(8) *Power and switching connections.* (a) Power and switching connections are shown in figure 51.

(b) Service data on metering socket 143 is covered in (1) above.

(c) Service data on power receptacle 144 is covered in (2) above.

(d) Service data on battery receptacle 145 is covered in (3) above.

(e) Service data on voltage regulator tube in socket 146 is covered in (4) above.

(f) Service data on receiver power plug 148 is covered in (5) above.

(g) Service data on switch 136 is covered in (6) above.

(h) Service data on switches 137 and 138 is covered in (7) above.

(i) Parts data for power and switching stage is covered in table XXVIII.

Table XXVIII. Parts data, power and switching schematic, transmitter (fig. 51.)

Reference symbol	Signal Corps stock No.	Name of part, description and function
74	3DA250-88	CAPACITOR, fixed: paper; 0.25-mf $\pm 20\%$; 200 vdcw; (105 v supply filter-bypass, a-f, from receiver).
98	3DA20-85	CAPACITOR, fixed: paper; 0.02-mf $\pm 20\%$; 300 vdcw; (audio-oscillator harmonic filter).
99	3DA100-209	CAPACITOR, fixed: paper; 0.1-mf $\pm 20\%$; 120 vdcw; (power supply hash bypass).
100	3DA100-209	CAPACITOR: same as 99; (same as 99).
111	3Z6620-71	RESISTOR: fixed; wire-wound; 20,000-ohm $\pm 5\%$; 10-w; (screen voltage dropping).
112	3Z6620-71	RESISTOR: fixed; wire-wound; 20,000-ohm $\pm 5\%$; 10-w; (screen voltage dropping).
113	3RC31AE200J	RESISTOR: fixed; carbon; 20-ohm $\pm 5\%$; 1-w; (measures plate current of p-a tube at metering socket 143).
118	3RC21BE183K	RESISTOR: fixed; carbon; 18,000-ohm $\pm 10\%$; $\frac{1}{2}$ -w; (equalize sidetone level between CW and MCW positions).
119	3RC21BE183K	RESISTOR: same as 118; (loads suppressor grid of Tube JAN-2E22 in MCW position).
121	3Z6006-17	RESISTOR: fixed; carbon; 60-ohm $\pm 10\%$; $\frac{1}{2}$ -w; (drops voltage to dial light).
122	3Z5999-3	RESISTOR: fixed; wire-wound on ceramic tube; 9.3-ohm $\pm 2\frac{1}{2}\%$; 5-w; (drops filament voltage to oscillator and modulator tubes).
134	3Z9824-42.1	SWITCH: push button; (dial light, on-off).
136	3Z9825-62.84	SWITCH: rotary; single-section; 3-position; bakelite insulation; (CW-MCW-PHONE selection).
137	3Z9825-62.88	SWITCH: rotary; single-section; 3-position; bakelite insulation; (HIGH-MED-LOW power output, varies screen voltage).
138	3Z9825-62.87	SWITCH: rotary; single-section; 3-position; bakelite insulation; (SEND-STANDBY-OFF selection).
143	2Z8678.52	SOCKET: octal; 8-prong; (metering socket for testing).
144	2Z7119.12	RECEPTACLE: plug; male; 9-prong; (power supply receptacle).
145	2Z8799-134	RECEPTACLE: plug; male; 4-prong; (battery receptacle, Battery BA-48).
146	2Z8678.52	SOCKET: octal; 8-prong; (regulator Tube JAN-OC-3/VR 105).
147	2Z5883-69	SOCKET ASSEMBLY: miniature bayonet; (dial light holder).
148	2Z7227-2	PLUG: male; polarized; 6-prong; (receiver power plug).
150	2Z5598-6	JACK: key; (plug in Key J-45).
151	2Z5598-6	JACK: microphone; (microphone input).
154	2Z9401.35	JACK: banana type; (antenna jack on case for receiver).
155	2Z5598-4	JACK: large banana type; (ground jack on case. Neg return for receiver).
156	2Z7594	RELAY: keying; 3-pole DT, 2-pole ST; two banks of contacts; (keying relay).
157	3H4858-7	RECTIFIER: selenium; dry disk; 157-ma; 13% @ 76°F.; (filament voltage regulator).
	2Z5889-3	DIAL LIGHT: 2 v; 60-ma; (illuminates dial).

SECTION IX

SUPPLEMENTARY DATA

40. Removal and Replacement of Ganged Tuning Capacitor (Transmitter)

a. **REMOVAL.** This capacitor and its cover may be removed to facilitate trouble shooting of parts located above and behind it. Reference should be made to figure 7 for cover removal, and figure 25 for panel parts removal in employing the following procedure:

(1) Lay the transmitter, panel down, and remove 12 screws marked A, figure 7, which will remove the cover.

(2) Stand the transmitter on its left side.

(3) Unclamp the TUNING DIAL lock and remove two screws. (See item 2, fig. 25.)

(4) Remove the TUNING dial, by backing out its setscrew.

(5) Remove three screws (item 5, fig. 25), which mount the ganged tuning capacitor to the front panel. (Do not lose the rubber washers on these screws.)

(6) The ganged tuning capacitor, which is a plug-in type, may now be removed from the rear, making all parts accessible. No unsoldering is required.

(7) Examine the banana plugs and jacks for corrosion, and clean if necessary with an eraser. Check also for bent plates, shorted trimmers, and unsoldered connections in the assembly.

Note. These plugs and jacks are silver-plated. Do not remove the silver plating by excessive burnishing.

(8) For detail of transmitter ganged tuning capacitor mounting, see figure 52.

b. **REPLACEMENT.** Note that the capacitor shaft has a flat. This flat should be rotated to position for easy tightening up of the setscrew of the frequency control dial after the assembly is replaced. The setscrew of the frequency control dial *must* be seated on the flat of the capacitor shaft, otherwise calibration will be inaccurate.

(1) Insert the capacitor assembly from the rear, making sure the banana plugs are properly seated in their respective jacks.

(2) Replace loosely the three mounting screws (item 5, fig. 25), with the rubber washer on each screw.

(3) Replace loosely the frequency control dial and clamping ring screws (item 2, fig. 25).

(4) Do not make up any screws until all are properly entered.

(5) Tighten securely the three screws, item 5.

(6) Lock the dial setscrew.

(7) Close clamping ring and tighten the two setscrews, item 2.

(8) Replace the cover by reinstalling the previously removed 12 screws marked A. (See fig. 7.)

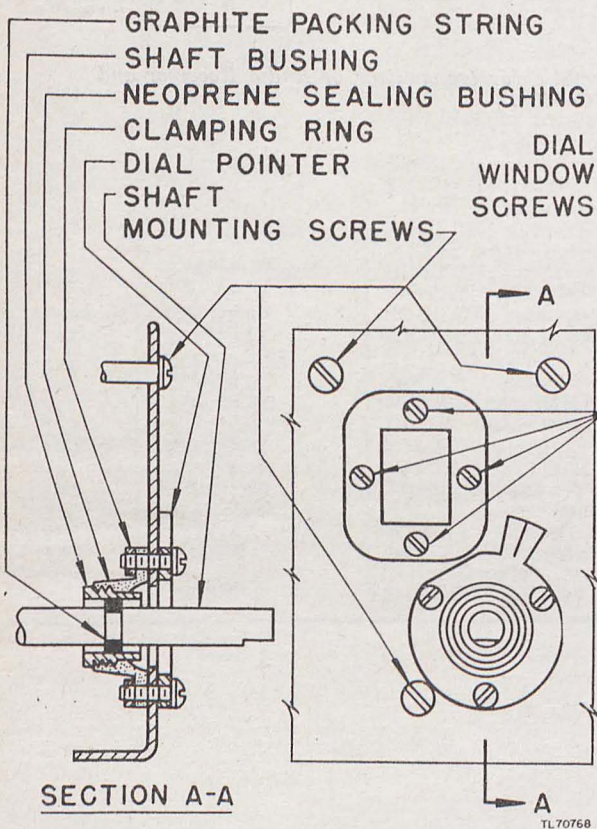

Figure 52. Detail of ganged tuning capacitor mounting in transmitter of Radio Receiver and Transmitter BC-1306.

(9) If a replacement capacitor assembly has been installed, screw 2 (on coil 127) and screw 3 (on coil 126), shown on figure 6, may require readjustment for proper tracking. (See par. 19b if necessary, for alignment.)

41. Noise and Distortion in Receiver

a. NOISE. Noise due to some defective component of the receiver can be traced to its source by considering it as a signal and locating the first point at which it occurs by means of an a-c vacuum-tube voltmeter. The following are some possible causes of noise:

(1) Noise is frequently caused by worn or otherwise defective volume controls and is most noticeable when turning the control.

(2) Noise frequently results from poor contact between the wipers and rotor of the tuning capacitor gang, showing up especially when the set is being tuned.

(3) In a sensitive receiver, intermittent contact between any of the parts of the tuning dial drive may generate noise in much the same way as a screw driver point drawn lightly over the chassis of a sensitive receiver will generate noises that are reasonably loud if the set is operating at maximum sensitivity.

(4) If B+ or filament circuit bypass capacitors are open-circuited the set may be noisy when operated from a generator or vibrator power source.

(5) Sparking at nearby generator or motor brushes, or at vibrator contacts, may result in noise being picked up by the antenna.

b. DISTORTION. The following are some possible causes of distortion:

(1) Leaky coupling capacitors in the audio circuit decrease the normal bias of the tube whose grid is connected to the defective capacitor. In some cases the leakage is large enough to make the grid actually positive which will make the quality very bad and quickly ruin the tube, especially if the tube is an output tube. A short circuit to ground at the cathode side of a cathode biasing resistor, or in its bypass capacitor, will cause similar effects.

(2) An open, fixed, tone-control capacitor in the plate circuit of a pentode output tube (such as capacitor 18 in Radio Receiver and Transmitter BC-1306) will allow the harmonics generated in the tube to be reproduced in accentuated amount, causing a particularly objectionable type of distortion.

(3) Regeneration may be caused by coupling in a common B supply impedance, or by stray capacitive coupling, and may result in frequency distortion or oscillation.

(4) Occasionally, regeneration may result in a stage oscillating at a high inaudible frequency causing the grid to draw current with its attendant distortion and resulting in very short tube life.

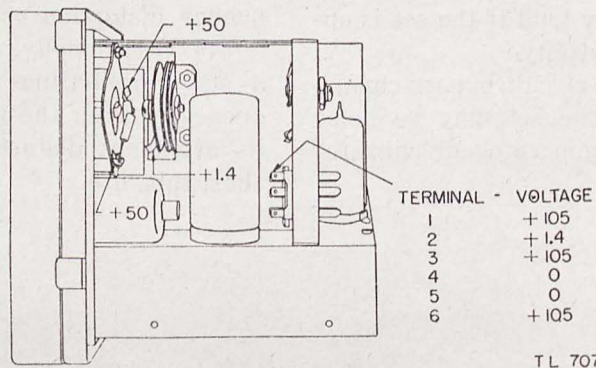
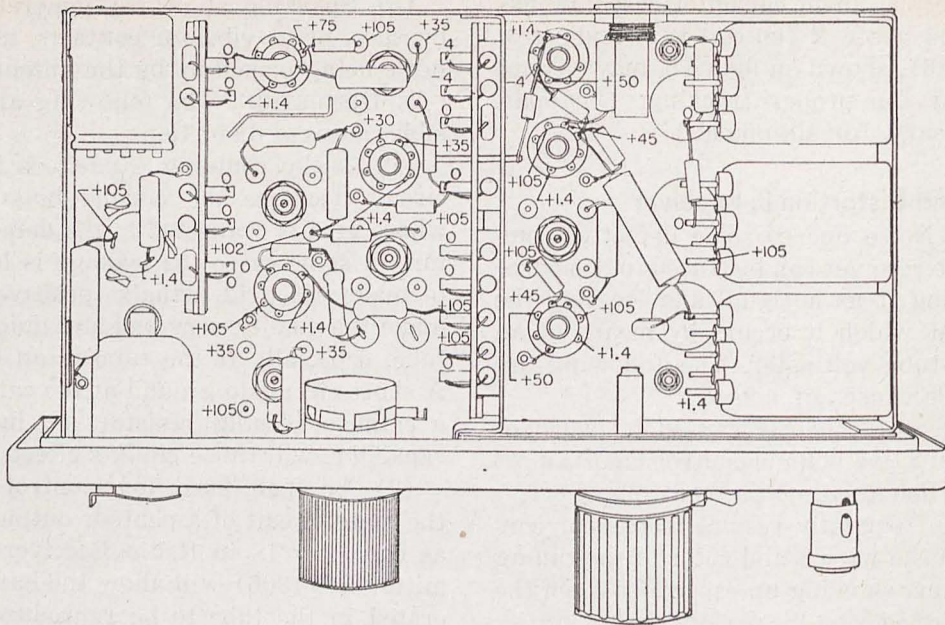

TL 70798

Figure 53. Normal voltages for receiver of Radio Receiver and Transmitter BC-1306.

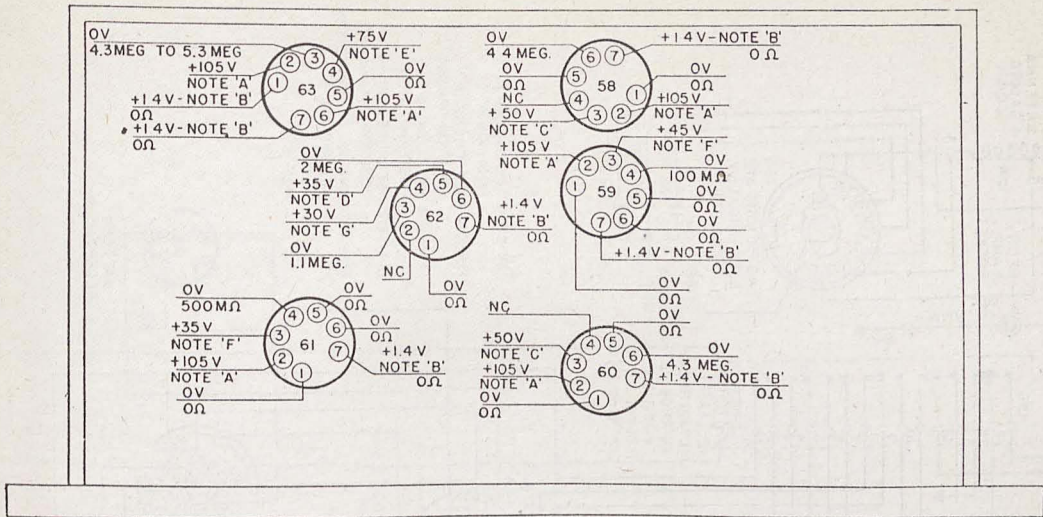

- NOTE 'A' - PHONE - CW - NET - CAL. SWITCH IN PHONE POSITION - ∞
 PHONE - CW - NET - CAL. SWITCH IN CW POSITION - ∞
 PHONE - CW - NET - CAL. SWITCH IN NET POSITION - 107M Ω
 PHONE - CW - NET - CAL. SWITCH IN CAL. POSITION - 107M Ω
- NOTE 'B' - WITH PHONE PLUG IN JACK
- NOTE 'C' - SENSITIVITY SWITCH IN LOW POSITION - 11 MEG } PHONE - CW - NET - CAL. SWITCH
 SENSITIVITY SWITCH IN MED POSITION - 1 MEG } IN NET POSITION
 SENSITIVITY SWITCH IN HI POSITION - 47M Ω }
- NOTE 'D' - PHONE - CW - NET - CAL. SWITCH IN PHONE POSITION - ∞
 PHONE - CW - NET - CAL. SWITCH IN CW POSITION - ∞
 PHONE - CW - NET - CAL. SWITCH IN NET POSITION - 380M Ω
 PHONE - CW - NET - CAL. SWITCH IN CAL POSITION - 380M Ω
- NOTE 'E' - PHONE - CW - NET - CAL. SWITCH IN NET POSITION - 130M Ω
- NOTE 'F' - PHONE - CW - NET - CAL. SWITCH IN NET POSITION - 140M Ω
- NOTE 'G' - PHONE - CW - NET - CAL. SWITCH IN NET POSITION - 1.3 MEG

- SOCKET 58 --- JAN - 1L4 R.F. AMP
 SOCKET 59 --- JAN - 1R5 MIXER - H.F. OSC
 SOCKET 60 --- JAN - 1L4 1ST IF AMP
 SOCKET 61 --- JAN - 1R5 2ND IF AMP
 SOCKET 62 --- JAN - 1S5 DET - 1ST A F - B F.O.
 SOCKET 63 --- JAN - 3Q4 AUDIO OUTPUT

ALL RESISTANCE MEASUREMENTS ARE WITH POWER CABLE UNPLUGGED

Figure 54. Tube socket voltages and resistances for receiver of Radio Receiver and Transmitter BC-1306.

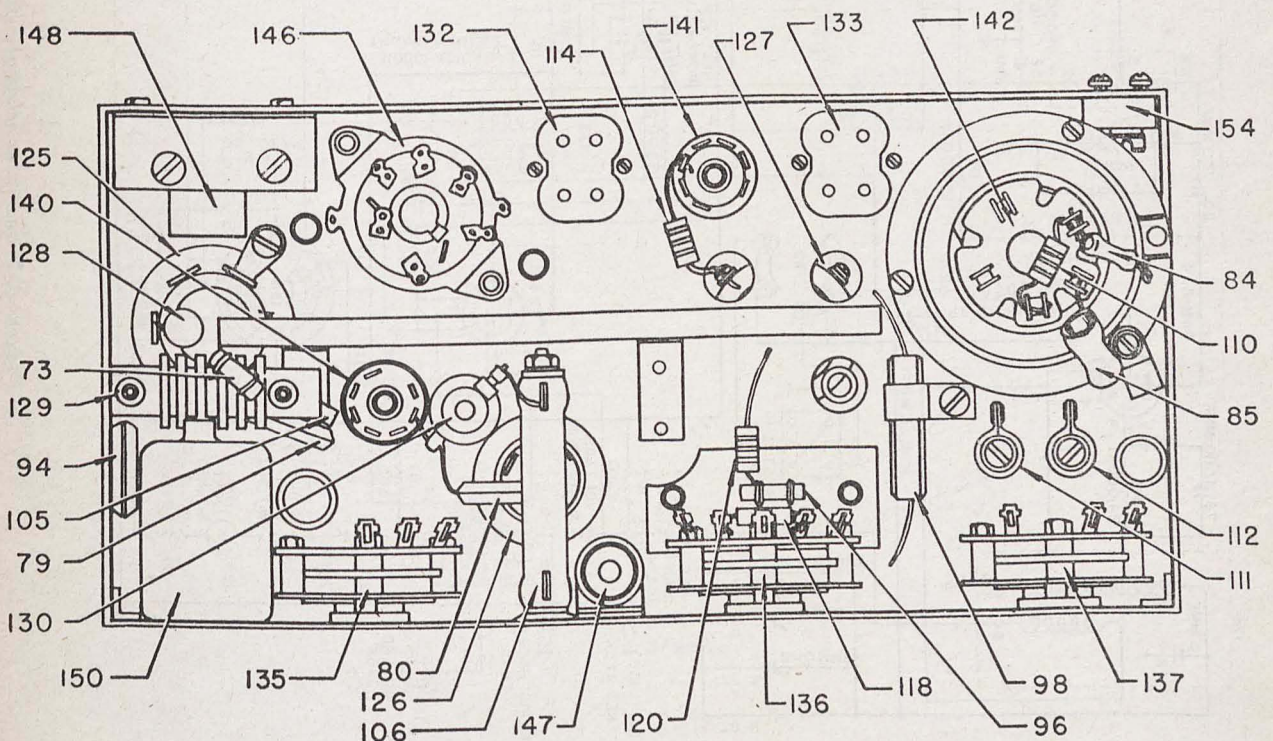

TL 70766

Figure 55. Parts identification for transmitter, bottom view, of Radio Receiver and Transmitter BC-1306.

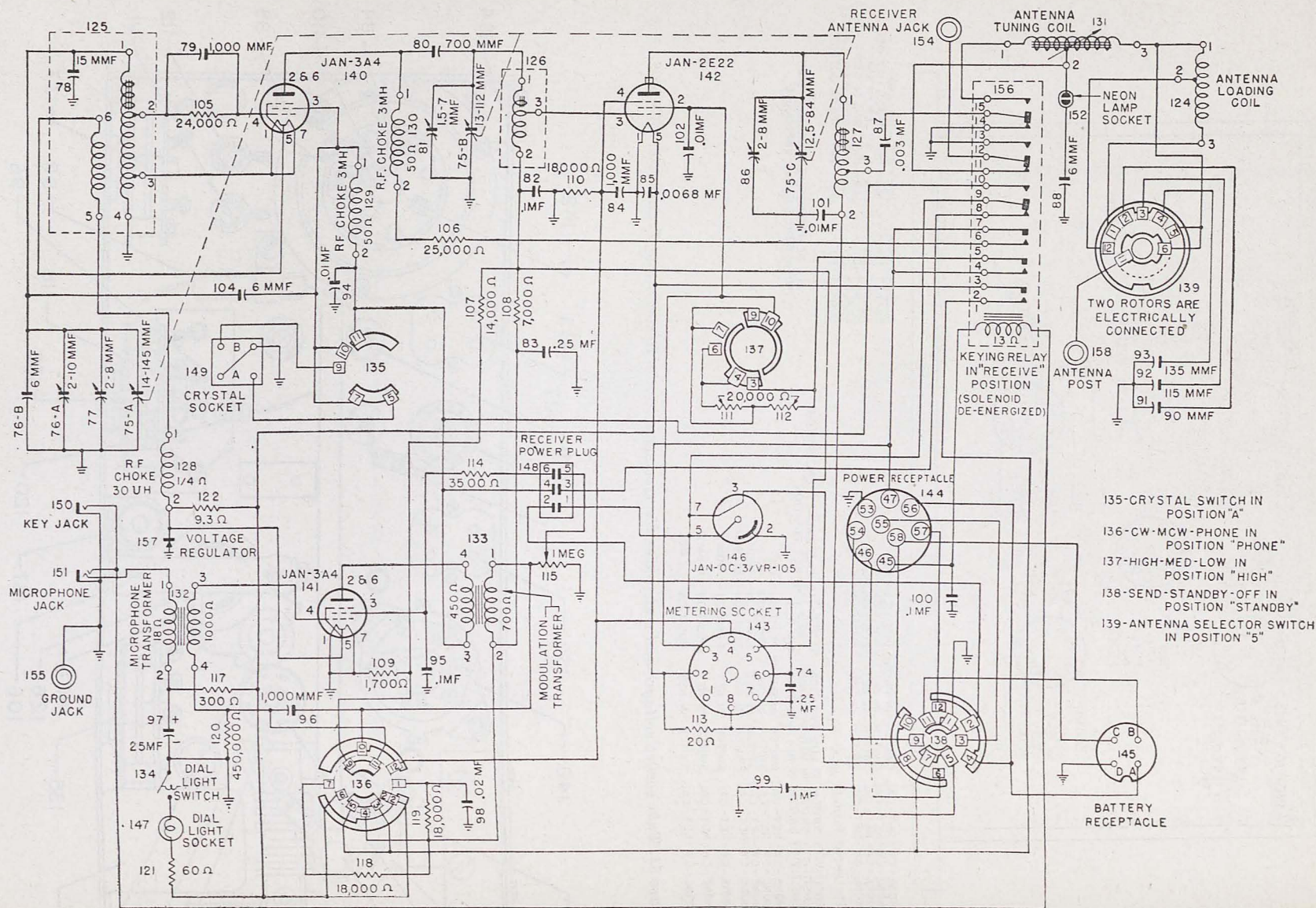

- 135-CRYSTAL SWITCH IN POSITION "A"
- 136-CW-MCW-PHONE IN POSITION "PHONE"
- 137-HIGH-MED-LOW IN POSITION "HIGH"
- 138-SEND-STANDBY-OFF IN POSITION "STANDBY"
- 139-ANTENNA SELECTOR SWITCH IN POSITION "5"

Figure 56. Transmitter schematic diagram of Radio Receiver and Transmitter BC-1306.

TL 70754

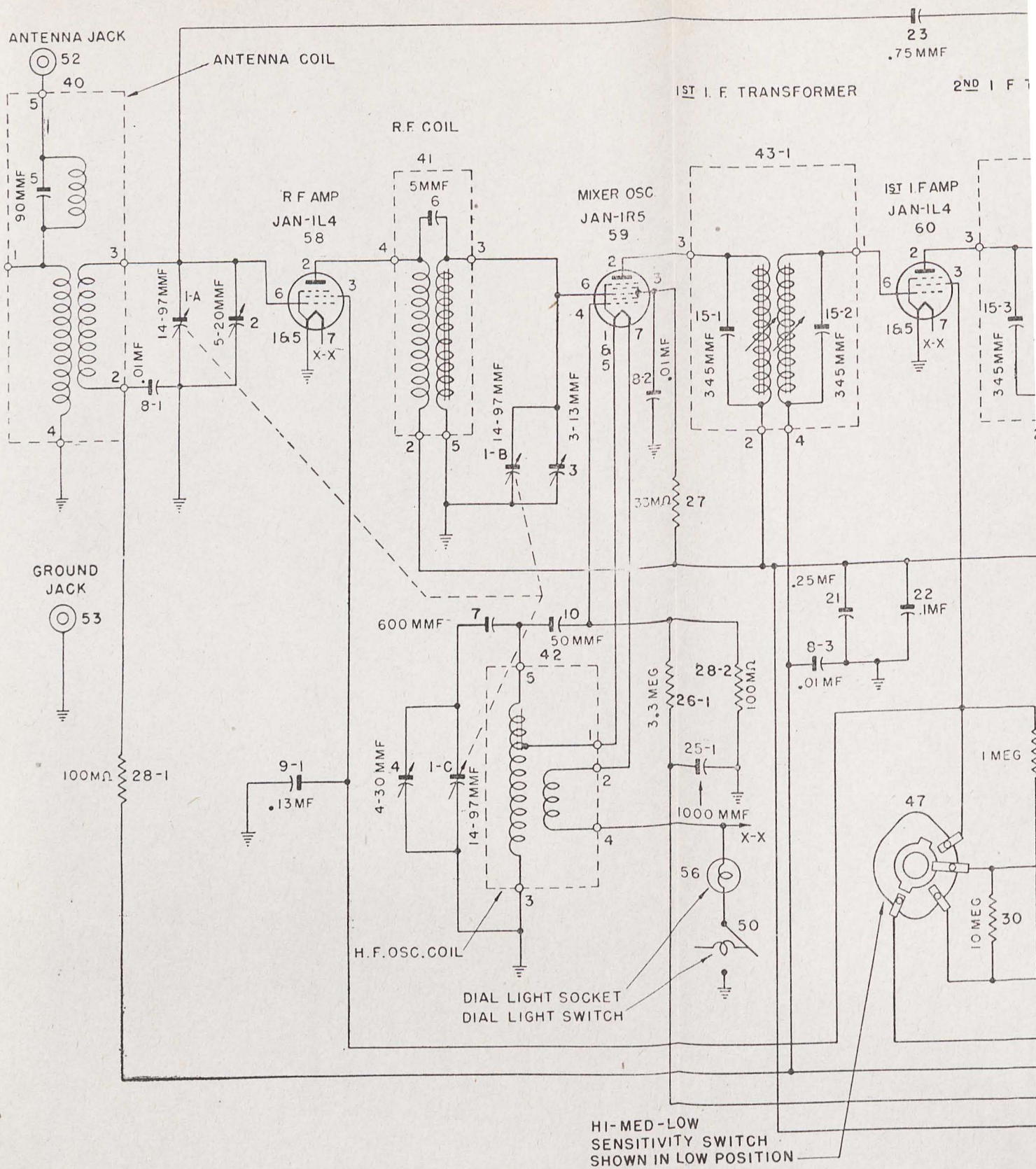
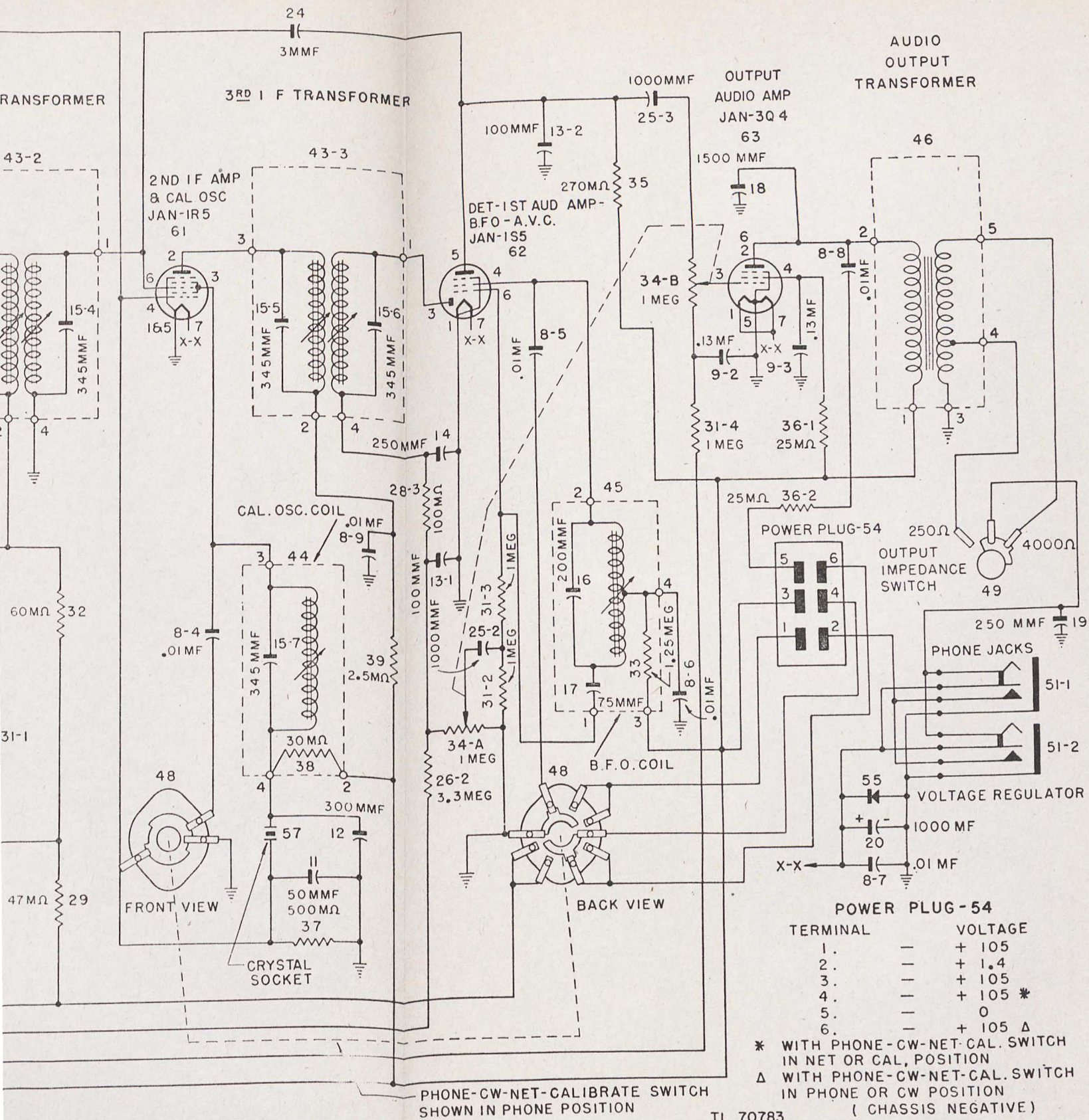

Figure 57. Receiver schematic diagram



POWER PLUG-54

TERMINAL	VOLTAGE
1.	+ 105
2.	+ 1.4
3.	+ 105
4.	+ 105 *
5.	0
6.	+ 105 Δ

* WITH PHONE-CW-NET-CAL. SWITCH IN NET OR CAL. POSITION
 Δ WITH PHONE-CW-NET-CAL. SWITCH IN PHONE OR CW POSITION
 (CHASSIS NEGATIVE)

TL 70783

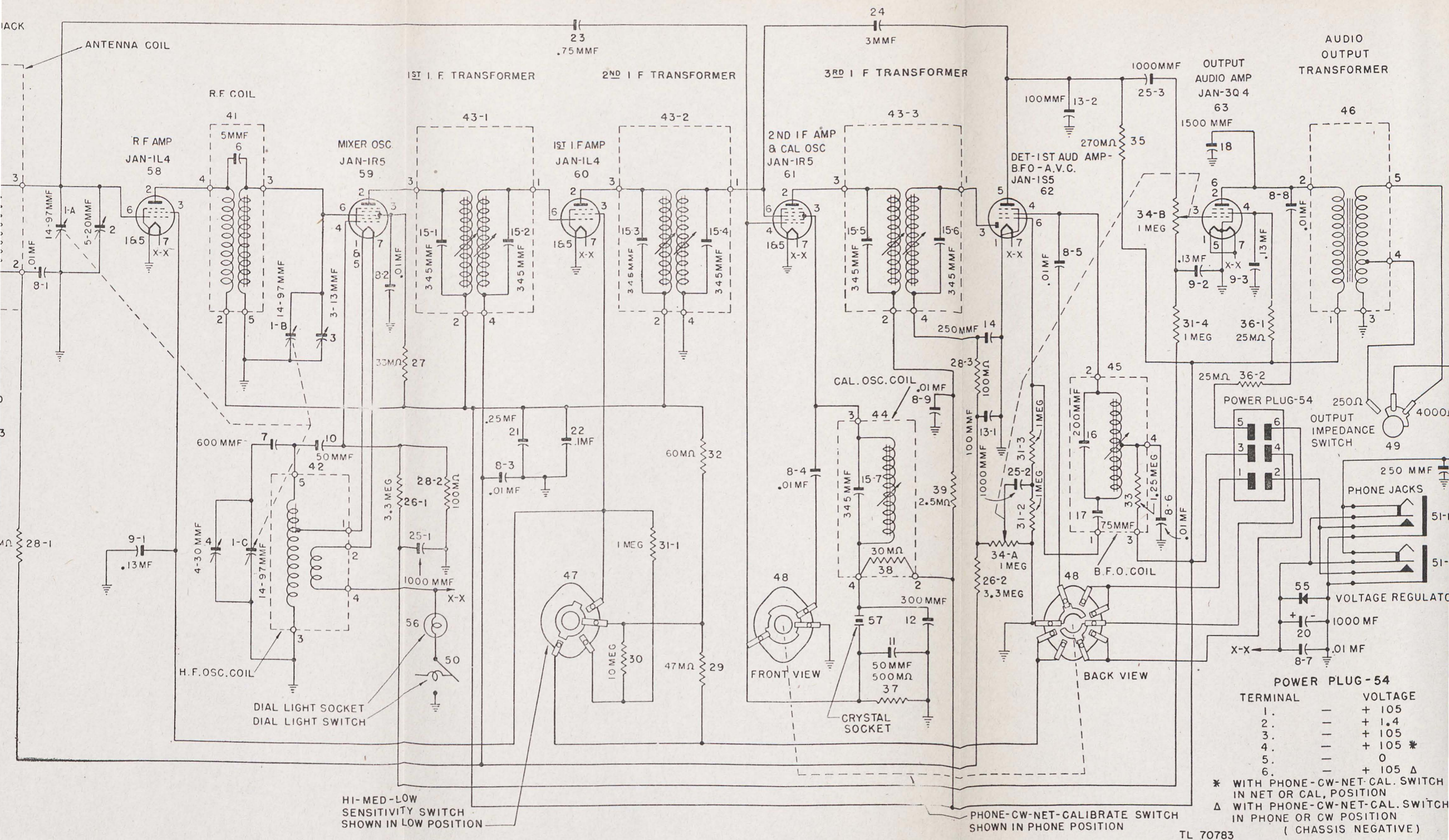

POWER PLUG-54

TERMINAL	VOLTAGE
1.	+ 105
2.	+ 1.4
3.	+ 105
4.	+ 105 *
5.	0
6.	+ 105 Δ

* WITH PHONE-CW-NET-CAL. SWITCH IN NET OR CAL. POSITION
 Δ WITH PHONE-CW-NET-CAL. SWITCH IN PHONE OR CW POSITION
 (CHASSIS NEGATIVE)

Figure 57. Receiver schematic diagram of Radio Receiver and Transmitter BC-130C.

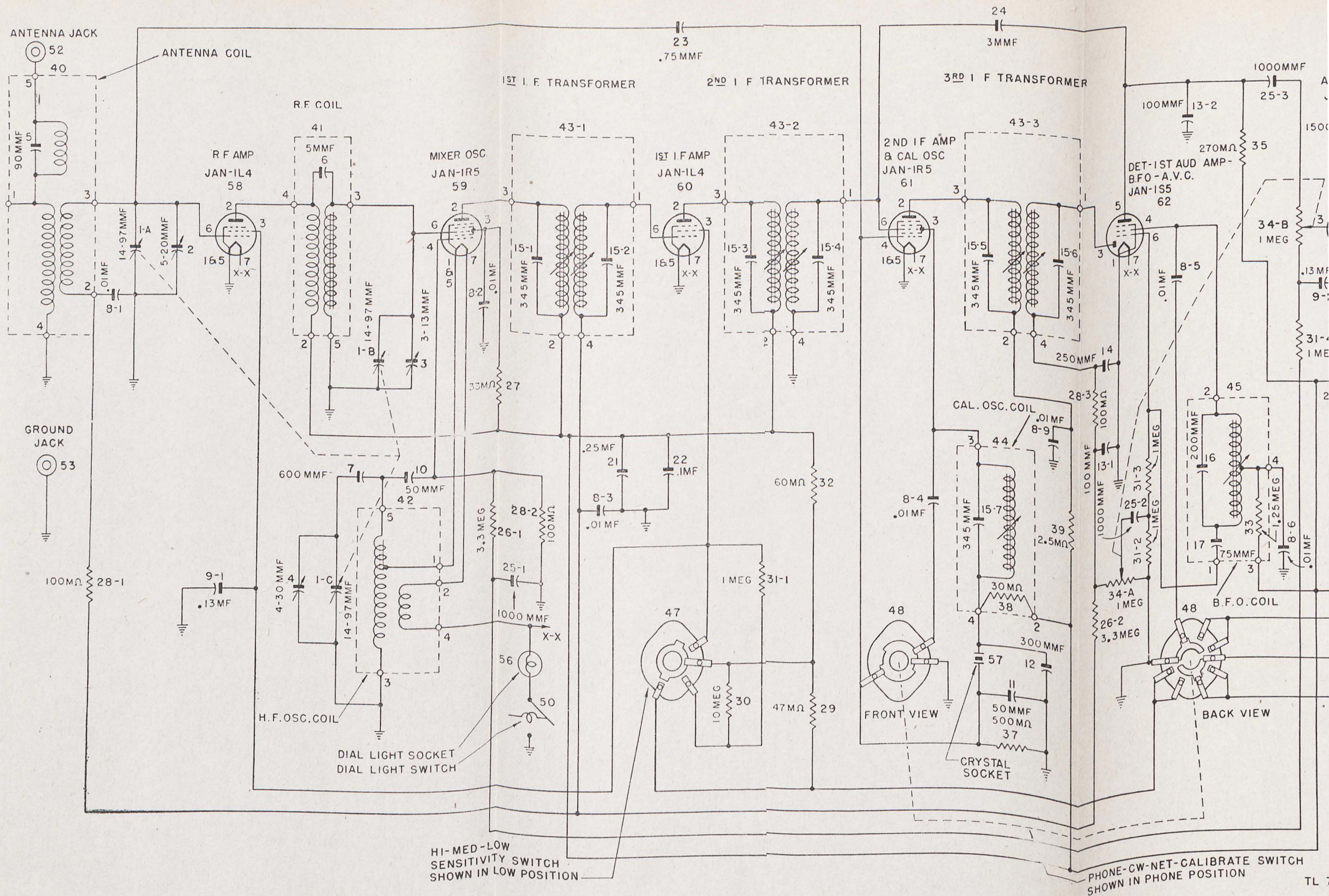

Figure 57. Receiver schematic diagram of Radio Receiver and Transmitter BC-130C.