



Your **definitive** source  
for quality pre-owned  
equipment.

**Artisan Technology Group**

(217) 352-9330 | [sales@artisanTG.com](mailto:sales@artisanTG.com) | [artisanTG.com](http://artisanTG.com)

**Full-service, independent repair center**

with experienced engineers and technicians on staff.

**We buy your excess, underutilized, and idle equipment**

along with credit for buybacks and trade-ins.

**Custom engineering**

so your equipment works exactly as you specify.

- Critical and expedited services
- In stock / Ready-to-ship
- Leasing / Rentals / Demos
- ITAR-certified secure asset solutions

**Expert team | Trust guarantee | 100% satisfaction**

All trademarks, brand names, and brands appearing herein are the property of their respective owners.

Find the Keysight / Agilent 8590B at our website: [Click HERE](#)

## Errata

**Title & Document Type:** 8590B/8591A/8593A/8592B/8594A/8595A Spectrum Analyzer Operation Manual

**Manual Part Number:** 08590-90001

**Revision Date:** July 1978

### About this Manual

We've added this manual to the Agilent website in an effort to help you support your product. This manual provides the best information we could find. It may be incomplete or contain dated information, and the scan quality may not be ideal. If we find a better copy in the future, we will add it to the Agilent website.

### HP References in this Manual

This manual may contain references to HP or Hewlett-Packard. Please note that Hewlett-Packard's former test and measurement, life sciences, and chemical analysis businesses are now part of Agilent Technologies. The HP XXXX referred to in this document is now the Agilent XXXX. For example, model number HP8648A is now model number Agilent 8648A. We have made no changes to this manual copy.

### Support for Your Product

Agilent no longer sells or supports this product. You will find any other available product information on the Agilent Test & Measurement website:

[www.agilent.com](http://www.agilent.com)

Search for the model number of this product, and the resulting product page will guide you to any available information. Our service centers may be able to perform calibration if no repair parts are needed, but no other support from Agilent is available.



**Agilent Technologies**

# HP/AGILENT

8590B

8591A

8593A

8592B

8594A

8595A

## OPERATION MANUAL

---

## Certification

Hewlett-Packard Company certifies that this product met its published specifications at the time of shipment from the factory. Hewlett-Packard further certifies that its calibration measurements are traceable to the United States National Institute of Standards and Technology, to the extent allowed by the Institute's calibration facility, and to the calibration facilities of other International Standards Organization members.

---

## Warranty

This Hewlett-Packard instrument product is warranted against defects in material and workmanship for a period of one year from date of shipment. During the warranty period, Hewlett-Packard Company will, at its option, either repair or replace products which prove to be defective.

For warranty service or repair, this product must be returned to a service facility designated by HP. Buyer shall prepay shipping charges to HP and HP shall pay shipping charges to return the product to Buyer. However, Buyer shall pay all shipping charges, duties, and taxes for products returned to HP from another country.

HP warrants that its software and firmware designated by HP for use with an instrument will execute its programming instructions when properly installed on that instrument. HP does not warrant that the operation of the instrument, or software, or firmware will be uninterrupted or error-free.

## Limitation of Warranty

The foregoing warranty shall not apply to defects resulting from improper or inadequate maintenance by Buyer, Buyer-supplied software or interfacing, unauthorized modification or misuse, operation outside of the environmental specifications for the product, or improper site preparation or maintenance.

NO OTHER WARRANTY IS EXPRESSED OR IMPLIED. HP SPECIFICALLY DISCLAIMS THE IMPLIED WARRANTIES OF MERCHANTABILITY AND FITNESS FOR A PARTICULAR PURPOSE.

## Exclusive Remedies

THE REMEDIES PROVIDED HEREIN ARE BUYER'S SOLE AND EXCLUSIVE REMEDIES. HP SHALL NOT BE LIABLE FOR ANY DIRECT, INDIRECT, SPECIAL, INCIDENTAL, OR CONSEQUENTIAL DAMAGES, WHETHER BASED ON CONTRACT, TORT, OR ANY OTHER LEGAL THEORY.

---

## Assistance

*Product maintenance agreements and other customer assistance agreements are available for Hewlett-Packard products.*

*For any assistance, contact your nearest Hewlett-Packard Sales and Service Office.*

---

## Safety Symbols

The following safety symbols are used throughout this manual. Familiarize yourself with each of the symbols and its meaning before operating this instrument.

---

### Caution



The *caution* sign denotes a hazard. It calls attention to a procedure which, if not correctly performed or adhered to, could result in damage to or destruction of the instrument. Do not proceed beyond a *caution* sign until the indicated conditions are fully understood and met.

---

### Warning



The *warning* sign denotes a hazard. It calls attention to a procedure which, if not correctly performed or adhered to, could result in injury or loss of life. Do not proceed beyond a *warning* sign until the indicated conditions are fully understood and met.

---

## General Safety Considerations

---

### Warning



*Before this instrument is switched on, make sure it has been properly grounded through the protective conductor of the ac power cable to a socket outlet provided with protective earth contact.*

**Any interruption of the protective (grounding) conductor, inside or outside the instrument, or disconnection of the protective earth terminal can result in personal injury.**

---

### Warning



**There are many points in the instrument which can, if contacted, cause personal injury. Be extremely careful.**

**Any adjustments or service procedures that require operation of the instrument with protective covers removed should be performed only by trained service personnel.**

---

### Caution



*Before this instrument is switched on, make sure its primary power circuitry has been adapted to the voltage of the ac power source.*

**Failure to set the ac power input to the correct voltage could cause damage to the instrument when the ac power cable is plugged in.**

---

# HP 8590 Series Spectrum Analyzer Documentation Description

## Manuals Shipped with Your Spectrum Analyzer

### Installation and Verification Manual

Describes how to install the spectrum analyzer.  
Tells how to make measurements with your spectrum analyzer.  
Details what to do in case of a failure.

### HP 8590 Series Operating Manual

Tells how to make measurements with your spectrum analyzer.  
Describes analyzer features.  
Describes common applications.

### HP 8590 Series Quick Reference Guide

Describes how to make a simple measurement with your spectrum analyzer.  
Briefly describes the spectrum analyzer functions.  
Lists all the programming commands.

## Options

### Option 910: Installation and Verification Manual, Operating Manual and Quick Reference Guide

Provides an additional copy of the installation and verification manual, the operating manual, and the quick reference guide.

### Option 915: Service Manual (Model Specific) and Component-Level Information

Describes troubleshooting and repair of the spectrum analyzer.

Option 915 consists of two manuals:

Service manual describes assembly level repair of the analyzer.

HP 8590B/91A/92B/93A/94A/95A Component-Level Information provides information for component-level repair of the spectrum analyzer.

### Options 021 and 023: HP 8590 Series Programming Manual

The *HP 8590 Series Spectrum Analyzer Programming Manual* describes analyzer operation via a remote controller (computer) for Options 021 and 023. This manual is provided when ordering either Option 021 or Option 023.

## How to Order Manuals

Each of the manuals listed above can be ordered individually. To order, contact your local HP Sales and Service Office.



# Contents

---

<b>1. Basic Operation</b>	
What You'll Learn in this Chapter . . . . .	1-1
Getting Acquainted with the Analyzer . . . . .	1-1
Front-Panel Features . . . . .	1-1
Rear-Panel Features . . . . .	1-5
Data Controls . . . . .	1-7
Hold Key . . . . .	1-7
Knob . . . . .	1-7
Number/Units Keypad . . . . .	1-7
Step Keys . . . . .	1-8
Fine-Focus Control . . . . .	1-8
Screen Annotation . . . . .	1-9
Menu and Softkey Overview . . . . .	1-11
Making a Measurement . . . . .	1-12
Measurement Summary . . . . .	1-14
Improving Accuracy with Self-Calibration Routines . . . . .	1-15
Warm-Up Time . . . . .	1-15
Performing the Tracking Generator Self-Calibration Routine (Option 010 or 011 only) . . . . .	1-16
Performing the YTF Self-Calibration Routine (HP 8592B, HP 8593A, or HP 8595A Only) . . . . .	1-17
When Is Self-Calibration Needed? . . . . .	1-17
Saving and Recalling Data from Analyzer Memory . . . . .	1-18
To Save a State . . . . .	1-18
To Recall a State . . . . .	1-18
To Save a Trace . . . . .	1-19
To Recall a Trace . . . . .	1-19
To Save a Limit-Line Table or Amplitude Correction Factors . . . . .	1-20
To Recall Limit-Line Tables or Amplitude Correction Factors . . . . .	1-20
To Protect Data From Being Overwritten . . . . .	1-20
Saving and Recalling Data from the Memory Card . . . . .	1-22
Preparing the Memory Card for Use . . . . .	1-23
To Enter a Prefix . . . . .	1-25
To Save a State . . . . .	1-25
To Recall a State . . . . .	1-25
To Save a Trace . . . . .	1-26
To Recall a Trace . . . . .	1-26
To Save Limit-Line Tables or Amplitude Correction Factors . . . . .	1-27
To Recall Limit-Line Tables or Amplitude Correction Factors . . . . .	1-27
Saving and Recalling Programs with a Memory Card . . . . .	1-28
To Save Programs . . . . .	1-28
To Recall Programs . . . . .	1-29



Using Limit-Line Functions . . . . .	1-31
Procedure for Creating an Upper Limit-Line . . . . .	1-31
Limit-Line Functions . . . . .	1-34
Editing, Creating, or Viewing Limit-Line Tables . . . . .	1-34
Selecting the Type of Limit-Line Table . . . . .	1-34
Selecting the Limit-Line Table Format . . . . .	1-34
Selecting the Segment Number . . . . .	1-35
Selecting the Frequency Coordinate . . . . .	1-37
Selecting the Amplitude Coordinate . . . . .	1-37
Selecting the Segment Type . . . . .	1-38
Completing Table Entry and Activating Limit-Line Testing . . . . .	1-39
Saving or Recalling Limit-Line Tables . . . . .	1-39
Procedure for Creating an Upper and Lower Limit-Line . . . . .	1-39
Using Amplitude Correction Functions . . . . .	1-41
Procedure for Creating Amplitude-Correction Factors . . . . .	1-42
Amplitude-Correction Functions . . . . .	1-44
Editing or Viewing the Amplitude-Correction Tables . . . . .	1-44
Selecting the Amplitude-Correction Point . . . . .	1-45
Selecting the Frequency Coordinate . . . . .	1-45
Selecting the Amplitude Coordinate . . . . .	1-46
Completing Table Entry and Activating Amplitude Corrections . . . . .	1-46
Saving or Recalling Amplitude Correction Tables . . . . .	1-46
External Keyboard . . . . .	1-47
Using the External Keyboard . . . . .	1-48
External Keyboard Installation . . . . .	1-48
To Enter a Screen Title . . . . .	1-49
To Enter Programming Commands . . . . .	1-49
To Enter a Prefix . . . . .	1-49
<b>2. Analyzer Measurements and Applications</b>	
What You'll Learn in This Chapter . . . . .	2-1
Resolving Signals of Equal Amplitude Using the Resolution Bandwidth Function . . . . .	2-2
Resolving Small Signals Hidden by Large Signals Using the Resolution Bandwidth Function . . . . .	2-4
Increasing the Frequency Readout Resolution Using the Marker Counter . . . . .	2-6
Decreasing the Frequency Span Using the Signal Track Function . . . . .	2-8
Peaking Signal Amplitude with Preselector Peak . . . . .	2-9
Tracking Unstable Signals Using Signal Track and the Maximum Hold and Minimum Hold Functions . . . . .	2-10
Comparing Signals Using Delta Markers . . . . .	2-13
Measuring Low-Level Signals Using Attenuation, Video Bandwidth, and Video Averaging . . . . .	2-17
Identifying Distortion Products Using the RF Attenuator and Traces . . . . .	2-23
Distortion from the Analyzer . . . . .	2-23
Third-Order Intermodulation Distortion . . . . .	2-25
Using the Analyzer As a Receiver in Zero Frequency Span . . . . .	2-27
Measuring Amplitude Modulation with the Fast Fourier Transform Function . . . . .	2-29
Measuring Signals Near Band Boundaries Using Harmonic Lock . . . . .	2-33
Using the Comb Generator to Perform More Accurate Frequency Measurements . . . . .	2-35
Stimulus-Response Measurements . . . . .	2-39
What Are Stimulus-Response Measurements? . . . . .	2-39

Spectrum Analyzer Functions Used . . . . .	2-40
Stepping Through the Measurement . . . . .	2-40
Tracking Generator Unleveled Condition . . . . .	2-45
Demodulating and Listening to an AM or FM Signal . . . . .	2-46
Triggering on a Selected Line of a Video Picture Field . . . . .	2-48
Making Reflection Calibration Measurements . . . . .	2-50
Reflection Calibration . . . . .	2-50
Measuring the Return Loss . . . . .	2-51
Using the Time-Gated Spectrum Analyzer Capability . . . . .	2-52
Introducing the Time-Gated Spectrum Analyzer Capability . . . . .	2-52
Using the Self-Calibration Routines with Option 105 . . . . .	2-54
Performing a Functional Check of Option 105 . . . . .	2-55
Using the Time-Gated Spectrum Analyzer Capability to View Pulsed RF . . . . .	2-57
Example of a Time-Gated Pulsed RF Signal . . . . .	2-58
Setting the Gate Delay and Gate Length Properly . . . . .	2-64
3. Analyzer Functions	
What You'll Learn in This Chapter . . . . .	3-1
Service Functions . . . . .	3-13
Service Calibration Functions . . . . .	3-13
Service Diagnostic Functions . . . . .	3-13
Analyzer Functions . . . . .	3-15
4. Key Menus	
A. Spectrum Analyzer Error Messages	
Index	

## Figures

---

1-1. Front-Panel Feature Overview . . . . .	1-2
1-2. Rear-Panel Feature Overview . . . . .	1-5
1-3. Adjusting the Fine Focus . . . . .	1-8
1-4. Screen Annotation . . . . .	1-9
1-5. Relationship between Frequency and Amplitude . . . . .	1-13
1-6. Reading the Amplitude and Frequency . . . . .	1-14
1-7. Inserting the Memory Card . . . . .	1-24
1-8. Typical Limit-Line Display . . . . .	1-31
1-9. The Completed Limit-Line Table . . . . .	1-33
1-10. Limit-Line Segments . . . . .	1-36
1-11. Segment Types . . . . .	1-38
1-12. Upper and Lower Limit-Line Testing . . . . .	1-41
1-13. Amplitude-Correction Display . . . . .	1-42
1-14. Completed Amplitude-Correction Table . . . . .	1-44
1-15. Amplitude-Correction Points . . . . .	1-45
2-1. Set-Up for Obtaining Two Signals . . . . .	2-2
2-2. Resolving Signals of Equal Amplitude . . . . .	2-3
2-3. Resolution Bandwidth Requirements for Resolving Small Signals . . . . .	2-4
2-4. Signal Resolution with a 10 kHz Resolution Bandwidth . . . . .	2-5
2-5. Signal Resolution with a 30 kHz Resolution Bandwidth . . . . .	2-6
2-6. Using the Marker Counter . . . . .	2-7
2-7. After Zooming In on the Signal . . . . .	2-8
2-8. Peaking Signal Amplitude Using Preselector Peak . . . . .	2-9
2-9. Using Signal Tracking to Track an Unstable Signal . . . . .	2-11
2-10. Viewing an Unstable Signal Using Max Hold A . . . . .	2-12
2-11. Viewing an Unstable Signal With Max Hold, Clear Write, and Min Hold . . . . .	2-13
2-12. Placing a Marker on the CAL OUT Signal . . . . .	2-14
2-13. Using the Marker Delta Function . . . . .	2-15
2-14. Using the Delta Meas Function . . . . .	2-15
2-15. Frequency and Amplitude Difference Between Signals . . . . .	2-16
2-16. Low-Level Signal . . . . .	2-18
2-17. Using 0 dB Attenuation . . . . .	2-19
2-18. Decreasing Resolution Bandwidth . . . . .	2-20
2-19. Decreasing Video Bandwidth . . . . .	2-21
2-20. Using the Video Averaging Function . . . . .	2-22
2-21. Harmonic Distortion . . . . .	2-23
2-22. RF Attenuation of 10 dB . . . . .	2-24
2-23. No Harmonic Distortion . . . . .	2-25
2-24. Third-Order Intermodulation Equipment Setup . . . . .	2-26
2-25. Measuring the Distortion Product . . . . .	2-27
2-26. Viewing an AM Signal . . . . .	2-28
2-27. Measuring Modulation In Zero Span . . . . .	2-29

2-28. Maximum Modulation Frequency versus Sweep Time . . . . .	2-31
2-29. Using the FFT Function . . . . .	2-32
2-30. Using Harmonic Lock . . . . .	2-34
2-31. Harmonic Locking Off . . . . .	2-35
2-32. Measuring an Input Signal . . . . .	2-36
2-33. Using the Correct to Comb Function . . . . .	2-37
2-34. Frequency Readout with a Frequency Offset . . . . .	2-38
2-35. Block Diagram of a Spectrum-Analyzer/Tracking-Generator Measurement System . . . . .	2-39
2-36. Transmission Measurement Test Setup . . . . .	2-40
2-37. Tracking-Generator Output Power Activated . . . . .	2-41
2-38. Spectrum Analyzer Settings According to the Measurement Requirement . . . . .	2-42
2-39. Decrease the Resolution Bandwidth to Improve Sensitivity . . . . .	2-42
2-40. Manual Tracking Adjustment Compensates for Tracking Error . . . . .	2-43
2-41. Normalized Trace . . . . .	2-44
2-42. Measure the Rejection Range with Delta Markers . . . . .	2-45
2-43. Demodulation of an FM Signal . . . . .	2-46
2-44. Continuous Demodulation of an FM Signal . . . . .	2-47
2-45. Triggering on an Odd Field of a Video Format . . . . .	2-48
2-46. Triggering on an Even Field of a Video Format . . . . .	2-49
2-47. Reflection Measurement Short Calibration Test Setup . . . . .	2-50
2-48. Measuring the Return Loss of the Filter. . . . .	2-51
2-49. Viewing Time-Sharing of a Frequency with an Oscilloscope . . . . .	2-53
2-50. Viewing Time-Sharing of a Frequency with a Spectrum Analyzer . . . . .	2-53
2-51. Self-Calibration Data Results . . . . .	2-54
2-52. Rear Panel Connections for Option 105 . . . . .	2-55
2-53. Gate On . . . . .	2-56
2-54. Using the Level Gate Control . . . . .	2-56
2-55. Pulse Repetition Interval and Pulse Width (with Two Signals Present) . . . . .	2-57
2-56. Test Setup for Option 105 . . . . .	2-59
2-57. Setting the Center Frequency, Span, and Reference Level . . . . .	2-60
2-58. Setting the Sweep Time . . . . .	2-61
2-59. Setting the Gate Delay and Gate Length Using an Oscilloscope . . . . .	2-61
2-60. Using Time-Gating to View Signal 1 . . . . .	2-62
2-61. Placing the Gate Output During the Second Signal . . . . .	2-63
2-62. Viewing Both Signals with Time-Gating . . . . .	2-64
2-63. Gate Not Occurring During the Pulse . . . . .	2-64
2-64. Gate is Occurring at the Beginning of the Pulse . . . . .	2-65
3-1. Memory Card Catalog Information . . . . .	3-23
3-2. Analyzer Memory Catalog Information . . . . .	3-25
3-3. CATALOG ON EVENT Display . . . . .	3-27
3-4. Connecting a Printer to the Analyzer . . . . .	3-33

## Tables

---

1-1. RF Output Frequency Range . . . . .	1-4
1-2. Screen Annotation . . . . .	1-10
1-3. Screen Annotation for Trace, Trigger, and Sweep Modes . . . . .	1-11
1-4. Summary of Save and Recall Operations, Analyzer Memory . . . . .	1-21
1-5. Comparison of Analyzer Memory and Memory Card Operations . . . . .	1-23
1-6. Save and Recall Functions Using Memory Card . . . . .	1-30
1-8. External Keyboard Functions . . . . .	1-47
2-1. Determining Spectrum Analyzer Settings for Viewing a Pulsed RF Signal . . . . .	2-58
2-2. Pulse Generator Test Setup Settings . . . . .	2-59
2-3. Signal Generator Test Setup Settings . . . . .	2-60
2-4. Gate Delay, Resolution Bandwidth, Gate Length, and Video Bandwidth Settings . . . . .	2-66
2-5. Sweep Time Settings . . . . .	2-66
3-1. Key Summary by Functional Group . . . . .	3-2
3-2. Center Frequency and Span Settings for Harmonic Bands . . . . .	3-19
3-3. Memory Card Catalog Information . . . . .	3-24
3-4. Analyzer Memory Catalog Information* . . . . .	3-25
3-5. CATALOG ON EVENT Display Description . . . . .	3-26
3-5. Default Configuration Values . . . . .	3-35
3-6. Common Preset Conditions . . . . .	3-51
3-7. Model Specific Preset Conditions . . . . .	3-52
3-8. Preset Spectrum Conditions for All Models . . . . .	3-53



## Basic Operation

---

### What You'll Learn in this Chapter

This chapter introduces the basic functions of the HP 8590 Series Spectrum Analyzers. In this chapter you will:

- Get acquainted with the front-panel and rear-panel features.
- Get acquainted with the menus and softkeys.
- Learn about screen annotation.
- Make a basic measurement (the calibration signal).
- Learn how to improve measurement accuracy by using self-calibration routines.
- Save and recall data from analyzer memory.
- Save and recall data from the memory card.
- Learn about creating limit lines.
- Learn about entering amplitude correction factors.
- Use the external keyboard (Option 021 or 023 only).

---

#### Note



Before using your analyzer, please read Chapter 2, "Installation and Preparation for Use," in the Installation and Verification Manual for your instrument which describes how to install your analyzer and how to verify that it is operational. Chapter 2 describes many safety considerations that should not be overlooked.

---

---

### Getting Acquainted with the Analyzer

#### Front-Panel Features

The following section provides a brief description of front-panel features. Refer to Figure 1-1.

- 1 **Active function block** is the space on the screen that indicates the active function. Most functions appearing in this block can be changed using the knob, step keys, or data keys.
- 2 **Message block** is the space on the screen where **MEAS UNCAL** and the asterisk (\*) appear. If one or more functions are manually set (uncoupled), and the amplitude or frequency becomes uncalibrated, **MEAS UNCAL** appears. (Use **AUTO COUPLE**, **AUTO ALL** to recouple functions.) The asterisk indicates that a function is in progress.

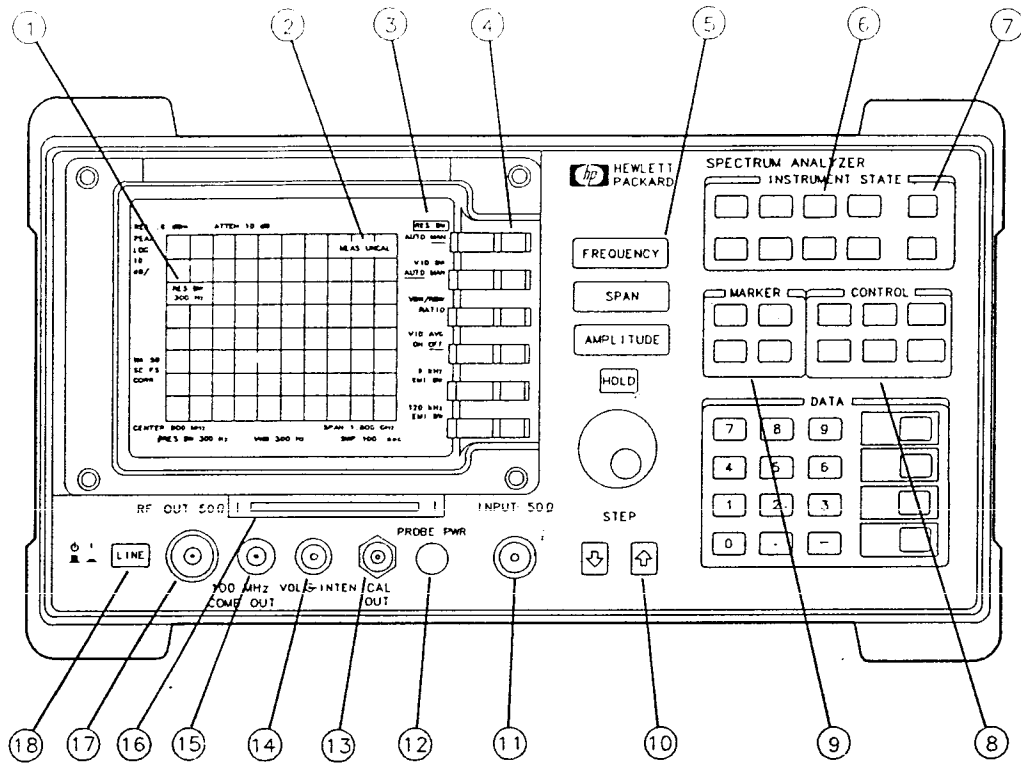

**Figure 1-1. Front-Panel Feature Overview**

- 3 **Softkey labels** are the annotation on the screen next to the unlabeled keys. Most of the labeled keys on the analyzer's front panel (also called front-panel keys) access menus of related softkeys.
  - 4 **Softkeys** are the unlabeled keys next to the screen.
  - 5 **FREQUENCY**, **SPAN**, and **AMPLITUDE** are the three large dark-gray keys that activate the primary analyzer functions and access menus of related functions.
  - 6 **INSTRUMENT STATE** functions affect the state of the entire spectrum analyzer. Self-calibration routines and special-function menus are accessed with these keys. The green **PRESET** key resets the analyzer to a known state. The **MODE** key accesses the current operating mode of the analyzer and allows you to change to any operating mode available for your analyzer. All analyzers have the spectrum analyzer mode of operation (indicated by **SPECTRUM ANALYZER**). If an additional softkey label appears in the softkey label area, a program (also called a downloadable program or personality) has been loaded into the analyzer's memory. This manual covers the spectrum analyzer mode of operation only; consult the documentation accompanying the HP 85711A Cable Television Measurements Card, the HP 85712B EMI Diagnostics Measurements Card, the HP 85713A Digital Radio Measurements Card, or the HP 85715A GSM Measurements Card for information about these other modes of operation.
- SAVE** and **RECALL** save and recall traces, states, limit-line tables, amplitude correction factors, and programs to or from a memory card. **SAVE** and **RECALL** also save and

## 1-2 Basic Operation



recall traces, states, limit-line tables, and amplitude correction factors to or from the analyzer memory.

---

**Note**

If you wish to reset the analyzer configuration to the state it was in when it was originally shipped from the factory, use **DEFAULT CONFIG**. Refer to the **DEFAULT CONFIG** softkey description in Chapter 3 for more information.

---

- 7 **COPY** prints or plots screen data. (This requires Option 021 or 023.) Use **CONFIG**, **PLOT CONFIG** or **PRINT CONFIG**, and **COPY DEV PRNT PLT** before using **COPY**.
  - 8 **CONTROL** functions access menus that allow you to adjust the resolution bandwidth, adjust the sweep time, store and manipulate trace data, and control the instrument display.
  - 9 **MARKER** functions control the markers, read out frequencies and amplitudes along the spectrum-analyzer trace, automatically locate the signals of highest amplitude, and keep a signal at the marker position in the center of the screen.
  - 10 **DATA** keys, **STEP** keys, and **knob** allow you to change the numeric value of an active function. **HOLD** deactivates an active function.
  - 11 **INPUT 50Ω** is the signal input for the spectrum analyzer. (**INPUT 75Ω** is the signal input for an Option 001 spectrum analyzer.)
- 

**Caution**

Excessive signal input will damage the analyzer input attenuator and input mixer. Use extreme caution when using the spectrum analyzer around high-power RF sources and transmitters. The maximum input power that the spectrum analyzer can tolerate appears on the front panel and should not be exceeded.

Excessive dc voltage can also damage the input attenuator. For your particular instrument, note the maximum dc voltage that should not be exceeded on the analyzer front panel (beneath the **INPUT 50Ω** connector).

---

- 12 **PROBE PWR** provides power for high-impedance ac probes or other accessories.
- 13 **CAL OUT** provides a calibration signal of 300 MHz at  $-20$  dBm (29 dBmV for Option 001 or 011).
- 14 **VOL-INTEN** or **INTENSITY**. The **VOL-INTEN** knob changes the brightness of the screen display and, if Option 102 or 103 is installed, the volume of the internal speaker. *For the HP 8591A, HP 8593A, HP 8594A, or HP 8595A only.*  
The **INTENSITY** knob changes the brightness of the screen display. *For the HP 8590B or HP 8592B only.*
- 15 **100 MHz COMB OUT** supplies a 100 MHz reference signal that has harmonics up to 22 GHz. *For the HP 8592B, HP 8593A, or HP 8595A only.*
- 16 **Memory card reader** reads from or writes to a memory card. The memory card reader is standard with an HP 8591A, HP 8593A, HP 8594A, and HP 8595A. It is also available for the HP 8590B and HP 8592B as Option 003.

---

**Caution**

If the tracking generator output power is too high, it may damage the device under test. Do not exceed the maximum power that the device under test can tolerate.

---

- 17 **RF OUT 50Ω** supplies a source output for the built-in tracking generator.  
*For Option 010 only. See Table 1-1 below.*

**RF OUT 75Ω** supplies a source output for the built-in tracking generator.  
*For Option 011 only. See Table 1-1 below.*

**Table 1-1. RF Output Frequency Range**

Model Number	Option 010 Frequency Range	Option 011 Frequency Range
HP 8590B	100 kHz to 1.8 GHz	1 MHz to 1.8 GHz
HP 8591A	100 kHz to 1.8 GHz	1 MHz to 1.8 GHz
HP 8593A	300 kHz to 2.9 GHz	not available
HP 8594A	300 kHz to 2.9 GHz	not available
HP 8595A	300 kHz to 2.9 GHz	not available

- 18 **LINE** turns the instrument on and off. An instrument check is performed every time the instrument is turned on. After applying power, allow the temperature of the instrument to stabilize for best measurement results.

---

**Note**

The instrument continues to draw power when it is plugged into the ac power source even if the line power switch is off.

---

## Rear-Panel Features

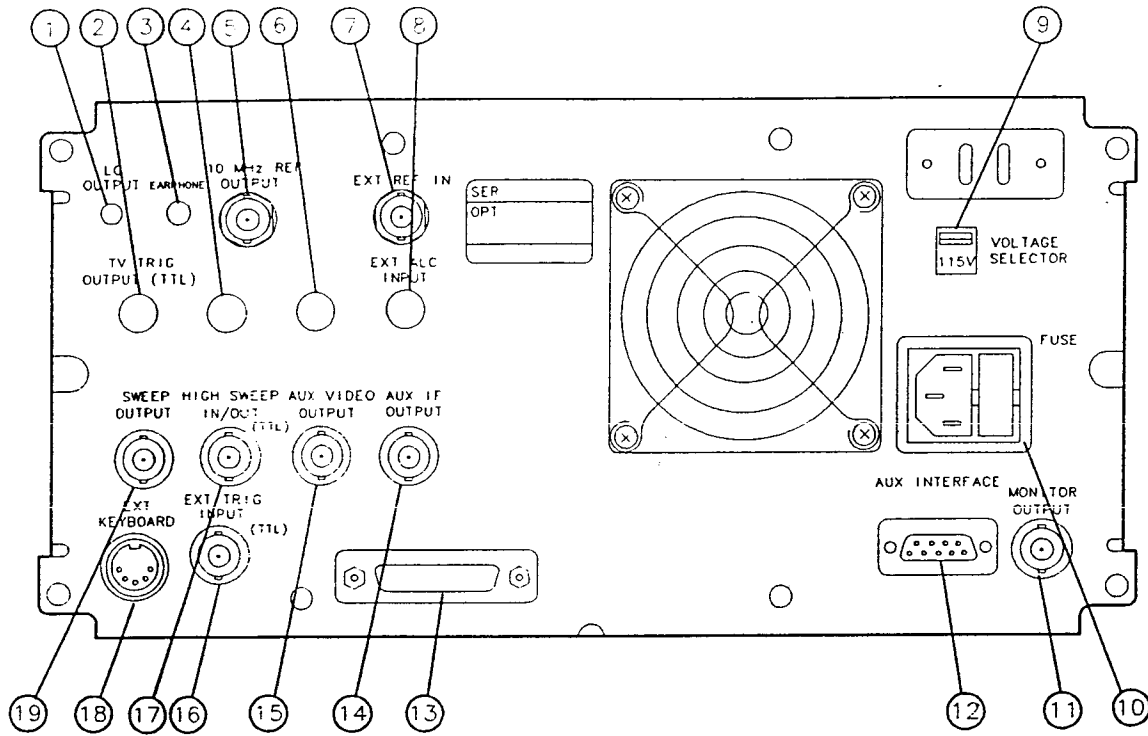

Figure 1-2. Rear-Panel Feature Overview

- 1 **LO OUTPUT** provides the output of the first LO, which is proportional to the frequency that the spectrum analyzer is tuned to. *For Option 009 only.*
  - 2 **TV TRIG OUTPUT (TTL)** provides TV trigger output using TTL and negative-edge triggering. *For Options 101 and 102 only.*
  - 3 **EARPHONE** connector provides a connection for an earphone jack instead of using the internal speaker. *For Option 102 or 103 only.*
  - 4 **SWEEP + TUNE OUTPUT** provides a voltage ramp that is proportional to the spectrum analyzer span (0 to 10 V) plus the tuning voltage of the LO. *For Option 009 only.*
- GATE TRIGGER INPUT (TTL)** accepts a TTL signal which acts as the gate trigger. In edge mode, the trigger event (positive or negative edge) initiates a gate delay. In level mode, the gate trigger input signal opens and closes the gate directly: TTL high sets the gate on; TTL low sets the gate off. When this input is unconnected, TTL is set high. *For Option 105 only.*
- 5 **10 MHz REF OUTPUT** provides a 10 MHz, 0 dBm minimum, time-based reference signal. *For an HP 8591A, HP 8593A, HP 8594A, or HP 8595A only.*

- 6 GATE OUTPUT (TTL) provides a TTL signal which indicates gate status when the when the gate is in edge trigger mode. A high TTL signal indicates the gate is on; a low TTL signal indicates the gate is off. GATE OUTPUT is not active in level mode. *For Option 105 only.*
- 7 EXT REF IN accepts an external frequency source to provide the 10 MHz, -2 to +10 dBm frequency reference used by the analyzer. *For an HP 8591A, HP 8593A, HP 8594A, or HP 8595A only.*
- 8 EXT ALC INPUT allows the use of an external detector or power meter for automatic leveling control of the tracking generator. *For an HP 8590B and HP 8591A Option 010 or 011 and, for an HP 8593A, HP 8594A, and HP 8595A Option 010 only.*
- 9 VOLTAGE SELECTOR adapts the unit to the power source: 115 V or 230 V.
- 10 Power input is the input for the line power source. Make sure that the line-power source outlet has a protective ground contact.
- 11 MONITOR OUTPUT drives an external monitor, such as the HP 82913A, with a signal that has a 19.2 kHz horizontal synchronizing rate.

---

**Caution**

Turn off the analyzer before connecting the AUX INTERFACE connector to a device. Failure to do so may result in loss of factory-correction constants.

Do not exceed the current limits for the +5 V supply when using the AUX INTERFACE connector. Exceeding the current limits may result in loss of factory-correction constants.

Do not use the AUX INTERFACE as a video monitor interface. Damage to the video monitor will result.

---

- 12 AUX INTERFACE provides a nine-pin "D" subminiature connector for control of external devices. Refer to Table 1-2 or Table 1-4 in the Installation and Verification Manual for your instrument for a more detailed description.
- 13 Interface connectors are optional interfaces for HP-IB and RS-232 interface buses that support remote instrument operation and direct plotting or printing of screen data.
- 14 AUX IF OUTPUT is a 50 $\Omega$ , 21.4 MHz IF output that is the down-converted signal of the RF input of the spectrum analyzer. Amplitude-correction factors are not applied to this signal.
- 15 AUX VIDEO OUTPUT provides detected video output (before the analog-to-digital conversion) proportional to vertical deflection of the trace. Output is from 0 V to 1 V. Amplitude-correction factors are not applied to this signal.
- 16 EXT TRIG INPUT (TTL) accepts the positive edge of an external voltage input that triggers the analyzer's internal sweep source.
- 17 HI SWEEP IN/OUT (TTL) indicates when the analyzer is sweeping or can be grounded to stop sweeping.

---

**Caution**

Turn off the analyzer before connecting an external keyboard to the analyzer.

---

## 1-6 Basic Operation

- 18 EXT KEYBOARD connector is provided with the optional interface connector. The external keyboard is not included with the analyzer. The external keyboard can be used to enter screen titles, prefixes, and remote commands. *For Options 021 and 023 only.*
- 19 SWEEP OUTPUT provides a voltage ramp proportional to the sweep and the analyzer span (0 V to 10 V).

## Data Controls

Data controls are used to change values for functions such as center frequency, start frequency, resolution bandwidth, and marker position.

The data controls will change the active function in a manner prescribed by that function. For example, you can change center frequency in fine steps with the knob, in discrete steps with the step keys, or to an exact value with the number/units keypad. For example, resolution bandwidth, which can be set to discrete values only, is changed to predetermined values with any of the data controls.

### Hold Key

Deactivate functions with **HOLD**. The active function readout is blanked, indicating that no entry will be made inadvertently by using the knob, step keys, or keypad. (Pressing a function key reenables the data controls.)

### Knob

The knob allows continuous change of functions such as center frequency, reference level, and marker position. It also changes the values of many functions that change in increments only.

Clockwise rotation of the knob increases values. For continuous changes, the extent of alteration is determined by the size of the measurement range; the speed at which the knob is turned does not affect the rate at which the values are changed.

The knob enables you to change the center frequency, start or stop frequency, or reference level in smooth scrolling action. The smooth scrolling feature is designed to move the trace display to the latest function value as the knob is turned. When either center frequency or reference level is adjusted, the signal will shift right or left or up or down with the rotation of the knob before a new sweep is actually taken. An asterisk is placed in the message block (the upper right-hand corner of the analyzer display) to indicate that the data on-screen does not reflect data at the current setting.

---

### Note



When using the knob to change frequency or amplitude settings, the trace data is shifted. Therefore, when using **MAX HOLD A**, **MAX HOLD B**, or **MIN HOLD C**, moving the center frequency with the knob will not simulate a drifting signal.

---

### Number/Units Keypad

The number/units keypad allows entry of exact values for many of the spectrum analyzer functions. You may include a decimal point in the number portion. If not, the decimal point is placed at the end of the number.

Numeric entries must be terminated with a units key. The units keys change the active function in a manner prescribed by that function. For example, the units keys for frequency span are **GHz**, **MHz**, **kHz**, and **Hz**, whereas the units for reference level are **+dBm**, **-dBm**, **mV**, and **μV**.

### Note



If an entry from the number/units keypad does not coincide with an allowed function value (for example, that of a 12 MHz bandwidth), the analyzer defaults to the nearest allowable value.

### Step Keys

The step keys allow discrete increases or decreases of the active function value. The step size depends upon the analyzer's measurement range or on a preset amount. Each press results in a single step change. For those parameters with fixed values, the next value in a sequence is selected each time a step key is pressed. Changes are predictable and can be set for some functions. Out-of-range values or out-of-sequence values will not occur using these keys.

### Fine-Focus Control

The fine-focus control is located on the side of the analyzer. Use the following procedure to adjust the fine-focus control:

1. Adjust the front-panel intensity control for a comfortable viewing intensity.
2. Use an adjustment tool or small screwdriver to access the fine-focus adjustment. See Figure 1-3. Adjust for a focused display.

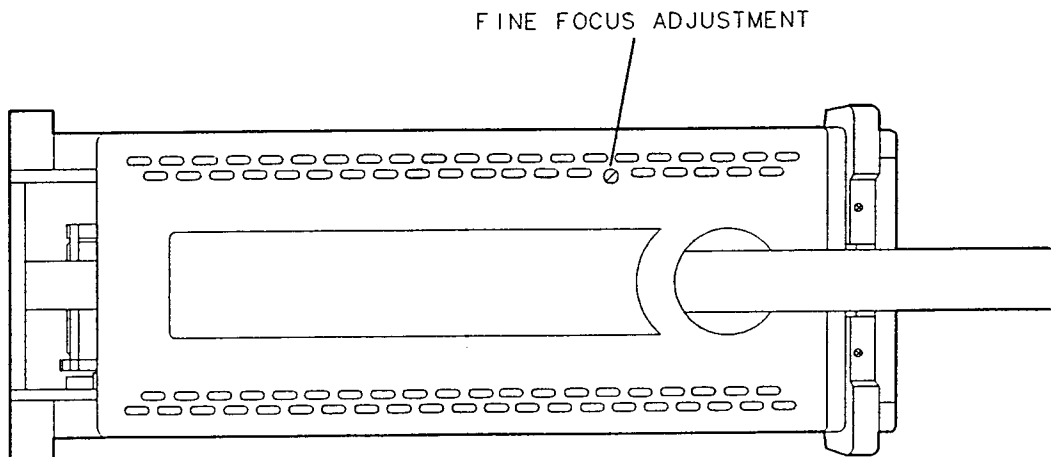

Figure 1-3. Adjusting the Fine Focus

## Screen Annotation

Figure 1-4 shows an example of the annotation that may appear on a spectrum analyzer screen. The screen annotation is referenced by numbers and is listed in Table 1-2. The function key column indicates which front-panel key or softkey activates the function related to the screen annotation. Refer to Chapter 3 for more information on a specific function key.

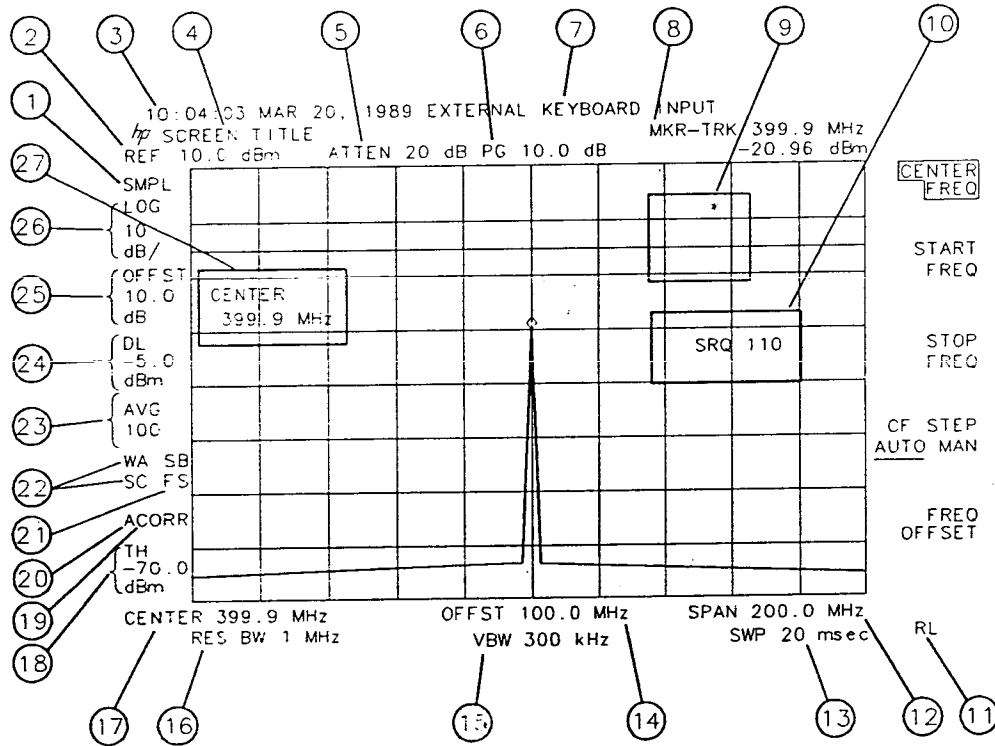

Figure 1-4. Screen Annotation

In Figure 1-4, item 21 refers to the trigger and sweep modes of the analyzer. The first letter (“F”) indicates the analyzer is in free-run trigger mode. The second letter (“S”) indicates the analyzer is in single-sweep mode.

Item 22 refers to the trace modes of the analyzer. The first letter (“W”) indicates that the analyzer is in clear-write mode. The second letter is “A,” representing trace A. The trace B trace mode is “SB”, indicating trace B (“B”) is in the store-blank mode (“S”). The trace mode annotation for trace C is displayed under the trace mode annotation of trace A. In Figure 1-4, the trace C trace mode is “SC”, indicating trace C (“C”) is in the store blank mode (“S”).

Refer to Table 1-3 for the screen annotation codes for trace, trigger, and sweep modes.

Table 1-2. Screen Annotation

Item	Description	Function Key
1	detector mode	DETECTOR SAMPL PK
2	reference level	REF LVL
3	time and date display	TIMEDATE ON OFF
4	screen title	CHANGE TITLE
5	RF attenuation	ATTEN AUTO MAN
6	preamplifier gain	EXT PREAMP
7	external keyboard entry	Refer to "External Keyboard" in this chapter.
8	marker or signal track readout	(MKR), (MKR ->), (SIGNAL TRACK), or (PEAK SEARCH)
9	measurement uncalibrated or function-in-progress messages	(AUTO COUPLE)
10	service request	See Appendix B
11	remote operation	See "(LOCAL)" in Chapter 3.
12	frequency span or stop frequency	(SPAN), STOP FREQ
13	sweep time	SWP TIME AUTO MAN
14	frequency offset	FREQ OFFSET
15	video bandwidth	VID BW AUTO MAN
16	resolution bandwidth	RES BW AUTO MAN
17	center frequency or start frequency	CENTER FREQ, START FREQ
18	threshold	THRESHLD ON OFF
19	correction factors on	CORRECT ON OFF
20	amplitude correction factors on	See "Using Amplitude-Correction Factors" in this chapter.
21	trigger	(TRIG)
22	trace mode	(TRACE)
23	video average	VID AVG ON OFF
24	display line	DSP LINE ON OFF
25	amplitude offset	REF LVL OFFSET
26	amplitude scale	SCALE LOG LIN
27	active function block	Refer to the description of the softkey function that was activated.



Table 1-3. Screen Annotation for Trace, Trigger, and Sweep Modes

Trace Mode	Trigger Mode	Sweep Mode
W = clear write (traces A/B/C)	F = free run	C = continuous
M = maximum hold (traces A/B)	L = line	S = single sweep
V = view (traces A/B/C)	V = video	
S = store blank (traces A/B/C)	E = external	
M = minimum hold (trace C)	T = TV (Options 101 and 102 only)	

## Menu and Softkey Overview

The keys labeled FREQUENCY, CAL, and MKR are all examples of front-panel keys. Pressing most front-panel keys accesses menus that are displayed along the right side of the display. These menus are called softkey menus.

Softkey menus list functions other than those accessed directly by the front-panel keys. To activate a function on the softkey menu, press the unlabeled key immediately to the right of the annotation on the screen. The unlabeled keys next to the annotation on the display screen are called softkeys.

Front-panel keys are designated with a box around the key label, for example, **AMPLITUDE**; softkeys are designated by shading on the key label, for example, **REF LEVEL**. The softkeys that are displayed depend on which front-panel key is pressed and which menu level is enabled.

If a softkey function's value can be changed, it is called an active function. The function label of the active function appears in inverse video. For example, press **AMPLITUDE**. This calls up the softkey menu of related amplitude functions. Note the function labeled **REF LVL** appears in inverse video. **REF LVL** also appears in the active function block, indicating that it is the active amplitude function and can now be changed using any of the data entry controls.

A softkey with ON and OFF in its label can be used to turn the softkey's function on or off. To turn the function on, press the softkey so that ON is underlined. To turn the function off, press the softkey so that OFF is underlined. The following example demonstrates how an ON or OFF softkey function will be annotated: **VID AVG ON OFF (ON)**.

A function with AUTO and MAN in the label can either be auto-coupled or have its value manually changed. The function's value can be changed manually by pressing the softkey until MAN is underlined, and then changing its value with the numeric keypad, knob, or step keys. To auto-couple a function, press the softkey so that AUTO is underlined. The following example demonstrates how an AUTO or MAN softkey function will be annotated: **ATTEN AUTO MAN (AUTO)**.

A summary of all front-panel keys and their related softkeys can be found in Chapter 4, "Key Menus".

---

## Making a Measurement

---

### Caution



Do not exceed the maximum input power. The maximum input power is +30 dBm (1 watt) continuous, 25 V dc with 10 dB attenuation or more for the HP 8591A. The maximum input power is +30 dBm (1 watt) continuous, 0 V dc. Use input attenuation of 10 dB or more in bands 1 through 4 for the HP 8593A, and with a dc-coupled input for an HP 8594A or HP 8595A.

---

Let's begin using the spectrum analyzer by measuring an input signal. Since the 300 MHz calibration signal (CAL OUT) is readily available, we will use it as our input signal.

You cannot hurt the analyzer by using the calibration signal and pressing any of the keys described in this section. Don't be afraid to play with the knob, step keys, or number/units keypad. (If you have experimented with other keys and wish to return to a known state, press the green **PRESET** key.)

1. First, turn the instrument on by pressing **LINE**. Wait for the power-up process to complete.
2. Press the green **PRESET** key.
3. Connect the analyzer's CAL OUT to the INPUT 50Ω with an appropriate cable.
4. Set the frequency.

Press the **FREQUENCY** key. **CENTER** appears on the left side of the screen, indicating that the center-frequency function is active. The **CENTER FREQ** softkey label appears in inverse video to indicate that center frequency is the active function. The active function block is the space on the screen within the graticule where the center frequency messages appear. Functions appearing in this block are active: their values can be changed with the knob, step keys, or number/units keypad. Set the center frequency to 300 MHz with the DATA keys by pressing 300 **MHz**. The knob and step keys can also be used to set the center frequency.

5. Set the span.

Press **SPAN**. **SPAN** is now displayed in the active function block, and the **SPAN** softkey label appears in inverse video to indicate it is the active function. Reduce the span to 20 MHz by using the knob, pressing the down key (**▼**), or pressing 20 **MHz**.

6. Set the amplitude.

When the peak of a signal does not appear on the screen, it may be necessary to adjust the amplitude level on the screen. Press **AMPLITUDE**. **REF LEVEL .0 dBm** appears in the active function block. The **REF LVL** softkey label appears in inverse video to indicate that reference level is the active function. The reference level is the top graticule line on the display and is set to 0.0 dBm. Changing the value of the reference level changes the amplitude level of the top graticule line.

If desired, use the reference level function to place the signal peak on the screen using the knob, step keys, or number/units keypad. (Marker functions determine the frequency and amplitude of a signal.)

Figure 1-5 demonstrates the relationship between center frequency and reference level. The box in the figure represents the spectrum analyzer screen. Changing the center frequency

changes the horizontal placement of the signal on the screen. Changing the reference level changes the vertical placement of the signal on the screen. Increasing the span increases the frequency range that appears horizontally on the screen.

**Note**

Analyzers with Option 001 or 011 display the amplitude values in dBmV. (Option 011 is available only for an HP 8590B or HP 8591A.)

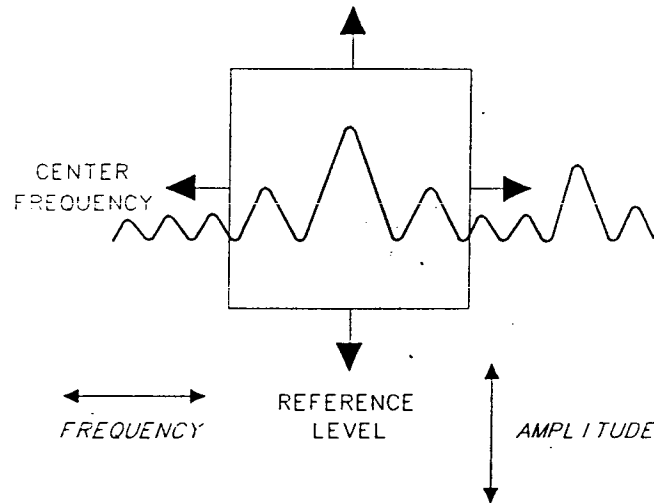

**Figure 1-5. Relationship between Frequency and Amplitude**

7. Set the marker.

You can place a diamond-shaped marker on the signal peak to find the signal's frequency and amplitude.

To activate a marker, press the **(MKR)** key (located in the MARKER section of the front panel). The **MARKER NORMAL** label appears in inverse video to show that the marker is the active function. Turn the knob to place the marker at the signal peak.

You can also use the **(PEAK SEARCH)** key, which automatically places a marker at the highest point on the trace.

Readouts of marker amplitude and frequency appear in the active function block and in the upper-right corner of the display. Look at the marker readout to determine the amplitude of the signal.

If another function is activated, the frequency and amplitude can still be identified by looking at the marker readout in the upper-right corner of the screen.

## Measurement Summary

1. Connect the analyzer's CAL OUT to the INPUT 50 $\Omega$  and press the **PRESET** key.
2. Set the center frequency by pressing the following keys: **FREQUENCY**, 300 **MHz**.
3. Set the span by pressing the following keys: **SPAN**, 20 **MHz**.
4. The calibration signal is 20 dB (two graticule divisions) below the top of the screen using these analyzer settings. If desired, adjust the reference level: press **AMPLITUDE** to activate the reference level, and use the knob or step keys to change the reference level.
5. Determine the amplitude and frequency of the signal. You can either press **PEAK SEARCH** or press **MKR** and move the marker to the signal peak. Read the amplitude and frequency. The display screen should look like the one in Figure 1-6. Frequency is displayed horizontally, and amplitude (power) is displayed vertically.

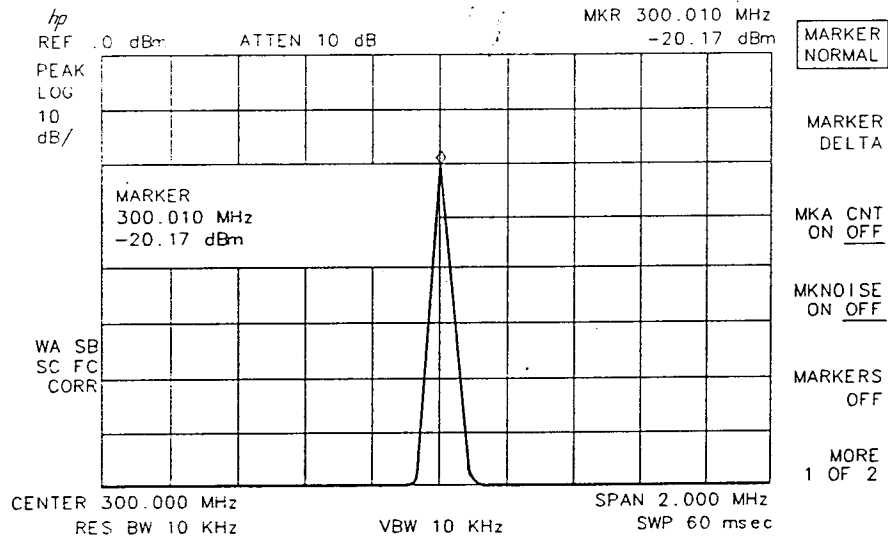

Figure 1-6. Reading the Amplitude and Frequency

### Note

Analyzers with Option 001 or 011 display the amplitude values in dBmV. (Option 011 is available only for an HP 8590B or HP 8591A.)



---

## Improving Accuracy with Self-Calibration Routines

Self-calibration routines improve the analyzer's frequency and amplitude accuracy. Press the **CAL** key to view the self-calibration routine menus. The last function on this menu, labeled **MORE 1 of 3**, provides access to additional self-calibration functions. For more detailed information on the self-calibration softkeys, refer to Chapter 3.

The self-calibration routines add correction factors to internal circuitry. The addition of the correction factors is required to meet frequency and amplitude specifications.

When the correction factors are added to internal circuitry, **CORR** (corrected) appears on the left side of the screen.

### Warm-Up Time

In order for the spectrum analyzer to meet its specifications, allow the analyzer to warm up for 30 minutes after being turned on before attempting to make any calibrated measurements. Be sure to calibrate the analyzer only *after* it has met operating temperature conditions.

The spectrum analyzer frequency and amplitude self-calibration routines are initiated by the **CAL FREQ & AMPTD** softkey in the menu located under the **CAL** key.

1. To calibrate the instrument, connect the analyzer's **CAL OUT** to the **INPUT 50Ω** connector with an appropriate cable.

---

#### Note



A low-loss cable should be used for accurate calibration. Use the 50Ω cable shipped with the analyzer (*Option 001 or 011 only*: use the 75Ω cable shipped with the analyzer).

2. On the analyzer, press **CAL** and **CAL FREQ & AMPTD**. **CAL SIGNAL NOT FOUND** will be displayed if **CAL OUT** is not connected to the analyzer input. The frequency and reference-level self-calibration functions take approximately 9 minutes to finish, at which time the internal adjustment data is in working RAM.
3. To save this data in the area of analyzer memory that is saved when the analyzer is turned off, press **CAL STORE**.

---

#### Note



To interrupt the calibration routines started by **CAL FREQ**, **CAL AMPTD**, or **CAL FREQ & AMPTD**, press **PRESET**, **CAL**, and **CAL FETCH**. **CAL FETCH** retrieves the previous correction factors. Improperly interrupting the self-calibration routines may result in corrupt correction factors. (If this occurs, press **CAL FREQ & AMPTD** to rerun the frequency and amplitude self-calibration routines.)

---

The frequency and amplitude self-calibration functions can be done separately by using the **CAL FREQ** or **CAL AMPTD** softkeys instead of **CAL FREQ & AMPTD**.

---

**Note**

If the frequency calibration **CAL FREQ** and the amplitude calibration **CAL AMPTD** self-calibration routines are used, the frequency calibration should be performed before the amplitude calibration, unless the frequency data is known to be accurate.

---

The **CAL FREQ** softkey starts the frequency self-calibration routine. This routine adjusts the frequency, sweep time, and span accuracy in approximately 2 minutes.

The **CAL AMPTD** softkey starts the amplitude calibration routine. This routine takes approximately 7 minutes to adjust the bandwidths, log and linear switching, IF gains, IF frequency centering, RF attenuation, and log amplifier. When the amplitude calibration routine has finished, the preset display returns and **CAL DONE** is displayed.

Although the analyzer stores the correction factors in battery-backed RAM, the data will not be saved when the analyzer power is turned off unless the data has been stored with **CAL STORE**. Using **CAL STORE** stores the correction factors in an area of analyzer memory that is accessed when the analyzer is turned on.

After the frequency and amplitude self-calibration routines are complete, **CORR** (corrected) now appears on the left side of the screen, indicating that the analyzer is using its frequency and amplitude correction factors. Correction factors can be turned off by pressing **CORRECT ON OFF**. When **OFF** is underlined, most amplitude correction factors and some frequency correction factors are not used.

If the self-calibration routines cannot be performed, see “Problems” in Chapter 5 of the Installation and Verification Manual of your instrument.

### Performing the Tracking Generator Self-Calibration Routine (Option 010 or 011 only)

In order for the tracking generator to meet its specifications, allow the analyzer to warm up for 30 minutes after being turned on before attempting to make any calibrated measurements. Be sure to calibrate the analyzer and the tracking generator only *after* the analyzer has met operating temperature conditions.

---

**Note**

Since the tracking-generator self-calibration routine uses the absolute amplitude level of the analyzer, the analyzer amplitude should be calibrated prior to using **CAL TRK GEN**.

---

1. To calibrate the tracking generator, connect the tracking generator output (RF OUT 50Ω) to the analyzer INPUT 50Ω connector, using an appropriate cable and adapters.

---

**Note**

A low-loss cable should be used for accurate calibration. Use the 50Ω cable shipped with the analyzer (*Option 001 or 011*: use the 75Ω cable shipped with the analyzer).

---

2. Press the following analyzer keys: **CAL**, **MORE 1 of 3**, **MORE 2 of 3**, and **CAL TRK GEN**. **TG SIGNAL NOT FOUND** will be displayed if the tracking generator output is not connected to the analyzer input.

3. To save this calibration data in the area of analyzer memory that is saved when the analyzer is turned off, press **CAL STORE**.

### **Performing the YTF Self-Calibration Routine (HP 8592B, HP 8593A, or HP 8595A Only)**

For HP 8592B, HP 8593A, and HP 8595A Spectrum Analyzers only, the YTF self-calibration routine should be performed periodically. See "When Is Self-Calibration Needed?" in the following section for some helpful guidelines on how often the self-calibration routines should be performed.

1. Connect a low-loss cable (such as HP part number 8120-5148) from 100 MHz COMB OUT to the analyzer input.
2. Press **[CAL]**, **CAL YTF**. The YTF self-calibration routine completes in approximately 4 minutes.
3. Press **[CAL]**, **CAL STORE**.

### **When Is Self-Calibration Needed?**

While it is difficult to provide general advice for your specific measurement needs, the following suggestions may help you decide when to use the self-calibration features:

1. Perform the frequency and amplitude self-calibration routines whenever the instrument experiences significant environmental changes such as temperature ( $\pm 5^{\circ}\text{C}$ ), humidity, shock, or vibration (such as may occur during shipping or transport). This is especially important if the frequency and amplitude self-calibration routines were performed last in a different environment.
2. If the environment is relatively stable (for example, a lab environment), use **CAL FREQ & AMPTD** monthly. After being turned off overnight, the analyzer will need to warm up, but should not require self-calibration.
3. To achieve optimal amplitude accuracy for relative measurements:
  - a. Keep the analyzer in a stable environment.
  - b. Use **CAL FREQ & AMPTD** before beginning the first measurement.
  - c. Keep the analyzer turned on between measurements.
  - d. Do not use **CAL FREQ & AMPTD** before subsequent measurements (the amplitude drift is normally smaller than the self-calibration uncertainty).
4. If you change the input signal for EXT REF IN, run the frequency and amplitude self-calibration routines using **CAL OUT**. Amplitude calibration is required to improve IF centering.
5. If preselector peaking (**PRESEL PEAK**) has more than a 2 dB effect on signal amplitude when in BAND 1 or above and in a single band sweep, then perform the YTF self-calibration routine with the COMB OUT signal and store the data with **CAL STORE**. The YTF self-calibration routine improves the preselector default values. (HP 8592B, HP 8593A, or HP 8595A only.)

6. If accurate self-calibration is needed temporarily in a different environment, use CAL FREQ & AMPTD , but do not press CAL STORE . The temporary correction factors will be used until the analyzer is turned off or until CAL FETCH is pressed.

---

## Saving and Recalling Data from Analyzer Memory

This section explains how to save and recall state, trace, limit line, and amplitude correction factor data to and from analyzer memory.

You can use STATE -> INTRNL to store up to eight states in analyzer memory, and TRACE -> INTRNL to store many traces, limit-line tables, and amplitude correction factors.

Saving state data saves the analyzer settings, but not the trace data. Saving trace data saves the trace data and the state data. Limit-line data and amplitude correction factors are stored in trace registers, but state and trace data are not recalled with the limit-line data or the amplitude correction factors. States, traces, limit-line tables, and amplitude correction factors are saved in analyzer memory even if the instrument is turned off or PRESET is pressed.

Refer to the CATALOG INTRNL softkey description in Chapter 3 for more information about cataloging analyzer memory.

Refer to Table 1-4 at the end of this section for a summary of saving and recalling data to and from analyzer memory.

### To Save a State

1. Set up the analyzer settings to be saved.
2. Press SAVE. If CRD is underlined, press INTRNL CRD to select INTRNL. Selecting INTRNL selects the analyzer memory as the mass storage device.
3. Press STATE -> INTRNL . SAVE: REG is displayed on the analyzer display.
4. Enter a number from one to eight using the numeric keypad. There is no need to press ENTER; the state is saved automatically.

### To Recall a State

1. Press RECALL. If CRD is underlined, press INTRNL CRD to select INTRNL.
2. Press CATALOG INTRNL and CATALOG REGISTER . Use the knob to highlight the number of the state register to be retrieved. The state registers have a "ST" preceding the register number.
3. Press LOAD FILE .

State data can also be recalled by specifying the register number:

1. Press RECALL. If CRD is underlined, press INTRNL CRD to select INTRNL.
2. Press INTRNL -> STATE .



3. Enter the register number under which the state was saved. There is no need to press **ENTER**; the state is recalled automatically.

---

**Note**

Register 9 is a special register which can aid in recovering from inadvertent loss of line power (power failure). Press **RECALL**, **INTRNL -> STATE**, then 9 to place the analyzer in the state that existed just prior to the loss of power.

---

### To Save a Trace

Saving trace data is very similar to saving state data. Saving trace data saves both the trace data and the state data.

1. Enter a screen title, if desired, by using **DISPLAY** and **CHANGE TITLE**.
2. Set up the trace to be stored.
3. Press **SAVE**. If **CRD** is underlined, press **INTRNL CRD** to select **INTRNL**.
4. Press **TRACE -> INTRNL**. This accesses a menu displaying **TRACE A**, **TRACE B**, and **TRACE C**.
5. Press the softkey for the trace that you want to save: **TRACE A**, **TRACE B**, or **TRACE C**. **REGISTER #** and **MAX REG # =** are displayed on the analyzer display. The number after **MAX REG # =** indicates the maximum register number that can be entered for trace storage in analyzer memory.
6. Use the numeric keypad to enter a number from 0 to the maximum register number and then press **ENTER**.

### To Recall a Trace

1. Press **RECALL**. If **CRD** is underlined, press **INTRNL CRD** to select **INTRNL**.
2. Press **CATALOG INTRNL**, **CATALOG REGISTER**. Use the knob to highlight the number of the trace register to be retrieved. The trace registers have a "TR" preceding the trace register number.
3. Press **LOAD FILE**. The recalled trace is placed into trace B and the analyzer state is changed to the state that was saved.

Trace data can also be recalled by specifying the register number:

1. Press **RECALL**. If **CRD** is underlined, press **INTRNL CRD** to select **INTRNL**.
2. Press **INTRNL ->TRACE**. This accesses a menu displaying **TRACE A**, **TRACE B**, **TRACE C**, **LIMIT LINES**, and **AMP COR**.
3. Press **TRACE A**, **TRACE B**, or **TRACE C** to select the trace in which you want to place the trace data.
4. Enter the register number under which the trace was stored.
5. Press **ENTER**. The recalled trace is placed in the view mode and the analyzer state is changed to the state that was saved.

## To Save a Limit-Line Table or Amplitude Correction Factors

The procedure for saving limit-line tables or amplitude correction factors is similar to saving trace data. State and trace data is not recalled with limit-line tables or amplitude correction factors.

1. Enter a screen title, if desired, by using **DISPLAY**, **CHANGE TITLE**. The screen title is displayed when **CATALOG REGISTER** is used to catalog the trace registers. The screen title is not recalled, however, with the limit-line tables or amplitude correction factors.
2. When saving limit-line tables, set up the limit-line table to be stored (see "Using the Limit-Line Functions" in this chapter). When saving amplitude correction factors, enter the data using the remote programming **AMPCOR** command or use the amplitude-correction function softkeys. See "Using Amplitude Correction Functions" in this chapter for more information about entering amplitude correction factors via the front-panel.
3. Press **SAVE**. If **CRD** is underlined, press **INTRNL CRD** to select **INTRNL**.
4. Press **TRACE -> INTRNL**. This accesses a menu with **LIMIT LINES** and **AMP COR**.
5. Press **LIMIT LINES** to save limit-line tables. Press **AMP COR** to save amplitude-correction factors. **REGISTER #** and **MAX REG # =** are displayed on the analyzer screen. The number after **MAX REG # =** indicates the maximum register number that can be entered for storage in analyzer memory.
6. Use the numeric keypad to enter a number from 0 to the maximum register number and then press **ENTER**.

## To Recall Limit-Line Tables or Amplitude Correction Factors

1. Press **RECALL**. If **CRD** is underlined, press **INTRNL CRD** to select **INTRNL**.
2. Press **INTRNL -> TRACE**. This accesses a menu with **LIMIT LINES** and **AMP COR**.
3. Press either **LIMIT LINES** to recall a limit-line table or, **AMP COR** to recall amplitude-correction factors.
4. Enter the register number under which the data was stored.
5. Press **ENTER**.

## To Protect Data From Being Overwritten

If you want to protect all the state, trace, limit line, and amplitude correction data from being overwritten, press **SAVE**, then **SAV LOCK ON OFF** so that **ON** is underlined.

Table 1-4 summarizes the functions when saving and recalling data to and from analyzer memory.

Table 1-4. Summary of Save and Recall Operations, Analyzer Memory

Operation	Screen Title Available?	Register Range	Key Sequence
save state	No	1 to 8	<b>SAVE</b> STATE ->INTRNL (register number)
recall state	No	1 to 8*	<b>RECALL</b> INTRNL ->STATE (register number)†
save trace	Yes	0 to MAX REG #	<b>SAVE</b> TRACE -> INTRNL (TRACE A, TRACE B, or TRACE C) (register number) <b>ENTER</b>
recall trace	Yes	0 to MAX REG #	<b>RECALL</b> INTRNL - >TRACE (TRACE A, TRACE B, or TRACE C) (register number) <b>ENTER</b> †
save limit line	Yes‡	0 to MAX REG #	<b>SAVE</b> TRACE -> INTRNL LIMIT LINES (register number) <b>ENTER</b>
recall limit lines	No	0 to MAX REG #	<b>RECALL</b> INTRNL - >TRACE LIMIT LINES (register number) <b>ENTER</b>
save amplitude correction factors	Yes‡	0 to MAX REG #	<b>SAVE</b> TRACE -> INTRNL AMP COR (register number) <b>ENTER</b>
recall amplitude correction factors	No	0 to MAX REG #	<b>RECALL</b> INTRNL - >TRACE AMP COR (register number) <b>ENTER</b>
<p>* Registers 1 through 8 are available for the user to save a state. State register 0 contains the current state of the analyzer, state register 9 contains the previous state of the analyzer.</p> <p>† The alternate method for recalling data uses the key sequence: <b>RECALL</b>, <b>CATALOG INTRNL</b>, <b>CATALOG REGISTER</b>, use the step keys or knob to highlight the item to be recalled, <b>LOAD FILE</b>.</p> <p>‡ The screen title is displayed when cataloging the trace registers with <b>CATALOG REGISTER</b>. The screen title is not recalled with the limit-line tables or amplitude correction factors.</p>			

---

## Saving and Recalling Data from the Memory Card

---

### Note

Option 003 is required when using an HP 8590B or HP 8592B.



---

The memory card provides additional memory for saving instrument states, traces, limit-line tables, amplitude correction factors, and programs. Each battery-backed RAM card provides 32 kilobytes of memory. Instrument states, traces, limit-line tables, amplitude-correction factors, and programs are easily retrievable without the need for an external controller to transfer data.

The process of saving and recalling data from the memory card is similar to saving and recalling data from the analyzer memory. Due to the expanded capabilities of the memory card, there are some important differences. For example, data is stored in analyzer memory as an item; on the memory card data is stored as a logical interchange file (LIF). Memory card data can be stored and recalled using a prefix. A prefix is an optional user-defined label for states, traces, and programs. The prefix becomes part of the file name. If you do not specify a prefix, a default file name is created. Table 1-5 compares the save and recall operations of analyzer memory and the memory card.

Refer to Table 1-6 at the end of this section for a summary of saving and recalling data to and from analyzer memory.

Table 1-5. Comparison of Analyzer Memory and Memory Card Operations

Mass Storage Device	Data Stored As	Stored with a Prefix?	Restriction on Register Number	Types of Data That Can Be Stored*	Catalog Functions Available
Analyzer Memory	Item	No	1 to 8 for states, 0 to MAX REG # for traces, limit lines, amplitude correction factors	States, traces, limit-line tables, amplitude correction factors	CATALOG ALL CATALOG REGISTER CATALOG VARIABLES CATALOG ON EVENT CATALOG PREFIX CATALOG DLP DELETE FILE † LOAD FILE †
Memory Card	File	Yes	Prefix + register # ≤ 8 characters	States, traces, limit-line tables, amplitude correction factors, and downloadable programs	CATALOG ALL CATALOG STATES CATALOG TRACES CATALOG PREFIX CATALOG DLP CATALOG AMP COR CATALOG LMT LINE DELETE FILE LOAD FILE
<p>* Specifies types of data that can be stored by using normal front-panel operation.                  † When cataloging analyzer memory, LOAD FILE is available for CATALOG REGISTER only.                  ‡ DELETE FILE is not available for CATALOG REGISTER .</p>					

### Preparing the Memory Card for Use

**Note**



Improper insertion causes error messages to occur, but generally does not damage the card or instrument. Care must be taken, however, not to force the card into place. The cards are easy to insert when installed properly.

1. Locate the arrow printed on the card's label.
2. Insert the card with its arrow matching the raised arrow on the bezel around the card-insertion slot. See Figure 1-7.

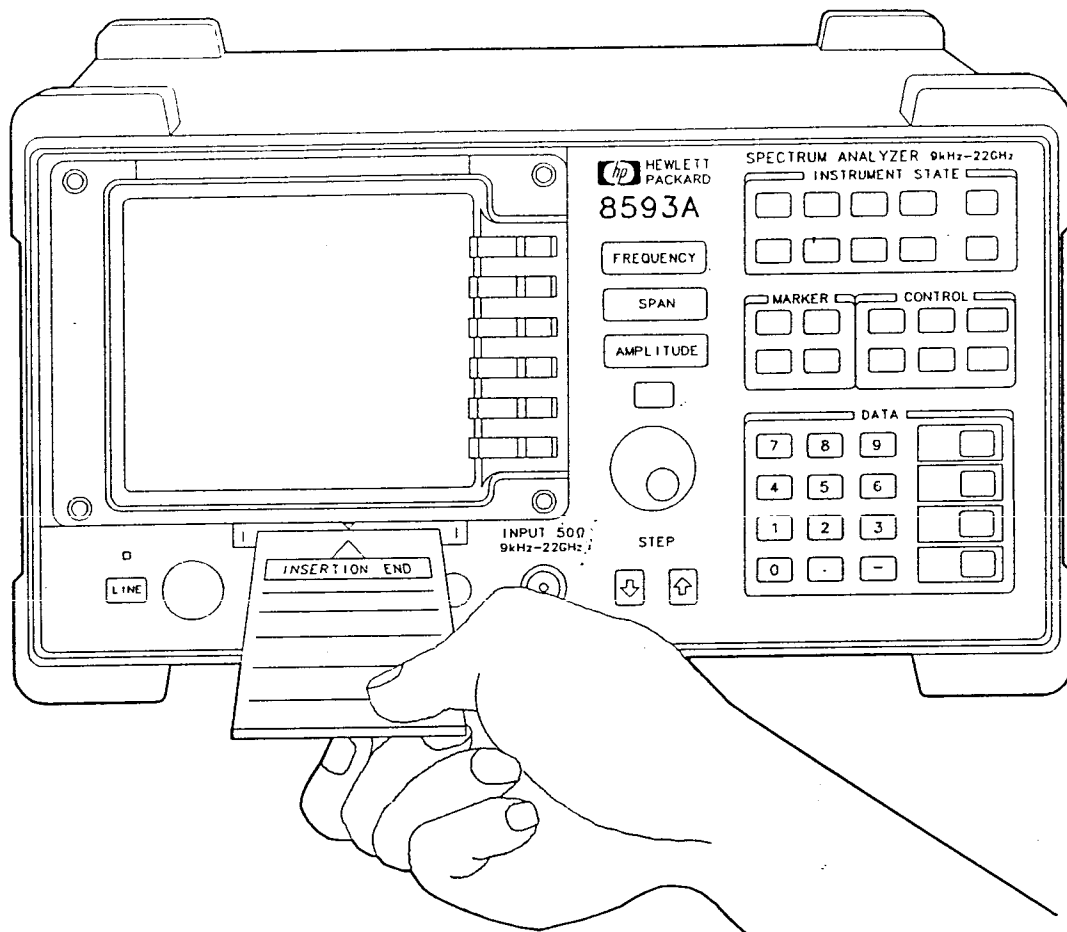

**Figure 1-7. Inserting the Memory Card**

3. Press the card into the slot. When correctly inserted, about 19 mm (0.75 in) of the card is exposed.
4. If this is a new memory card, it must be formatted before use. Since formatting a card deletes any data stored on the memory card, catalog the card before using the format card function if you suspect the memory card might contain data.

To format a new card, press **CONFIG**, **MORE 1 of 2**, **CARD CONFIG**, **FORMAT CARD**. The message **IF YOU ARE SURE, PRESS KEY AGAIN TO PURGE DATA** appears on the analyzer screen. Press **FORMAT CARD** again. (**FORMAT CARD** requires a double key press.)

To catalog a memory card, press **CONFIG**, **MORE 1 of 2**, **CARD CONFIG**, **CATALOG CARD**. **CATALOG CARD** either displays any existing data that is on the memory card (if the memory card has been formatted) or, displays **INVALID CARD: DIRECTORY** if the card has not been formatted. Use **BLANK CARD** if you wish to delete the files from the memory card.

## To Enter a Prefix

Memory card data can be stored and recalled using a prefix. To enter a prefix, press **DISPLAY** or **CONFIG**, **CHANGE PREFIX**.

Pressing **CHANGE PREFIX** accesses a menu containing the letters of the alphabet, the underscore symbol (**\_**), the number symbol (**#**), a space, and the clear function. To select a character, press the softkey that displays the group of characters that contains the desired character. The softkey menu changes to allow you to select an individual character. If you make a mistake, press **BK SP** to space back over the incorrect character. Additional characters are available by pressing **MORE 1 of 2**. Numbers may be selected with the numeric keypad.

The prefix can be from one to seven characters long. The longer the prefix, the shorter the register number must be. The total length of the prefix and register number cannot exceed eight characters. The prefix can be any character; however, the underscore should not be the first character of the prefix.

An existing prefix can be cleared with the clear function. Press **CONFIG** or **DISPLAY**, **CHANGE PREFIX**, **YZ\_# SPC CLEAR**, then **CLEAR** to clear the current prefix. To change a prefix, clear the existing prefix and then enter a new prefix.

## To Save a State

1. Press **DISPLAY** or **CONFIG**, **CHANGE PREFIX**. Use the softkeys to enter a prefix under which you want the state saved. A prefix can be one to seven characters long.

### Note



If there is not an existing prefix and you do not enter a prefix, the state data will be stored under a default file name consisting of "s," the underscore character (**\_**), and the register number you enter. If a prefix has been entered, the state data is saved under a file name that uses the prefix displayed on the analyzer screen.

2. Press **SAVE**. If **INTRNL** is underlined, press **INTRNL CRD** to select **CRD**. Selecting **CRD** selects the memory card as the mass storage device.
3. Press **STATE -> CARD . REGISTER #** and **PREFIX=** are displayed on the analyzer display.
4. Use the numeric keypad to enter a register number and then press **ENTER**.

## To Recall a State

1. Press **SAVE** or **RECALL**. If **INTRNL** is underlined, press **INTRNL CRD** to select **CRD**.
2. Press **CATALOG CARD** then **CATALOG STATES**. Use the knob to highlight the state data to be retrieved.
3. Press **LOAD FILE**.

State data can also be recalled by specifying the prefix and the register number:

1. Press **RECALL**. If **INTRNL** is underlined, press **INTRNL CRD** to select **CRD**.

2. Press **CARD** -> **STATE** .
3. Enter the register number that the state was saved under, and then press **ENTER** .

---

**Note**

If you want to recall a state saved under a different prefix, clear the existing prefix, use **CHANGE PREFIX** to enter the prefix, and then recall the state.

---

### To Save a Trace

Saving trace data saves the trace data and the state data.

1. Press **DISPLAY** or **CONFIG** , and then **CHANGE PREFIX** to enter a new prefix or change the existing prefix.

---

**Note**

If you do not enter a new prefix, the existing prefix will be used. If there is not an existing prefix, the trace will be saved under t\_(register number).

---

2. Enter a screen title, if desired, by using **DISPLAY** then **CHANGE TITLE** .
3. Set up the trace to be stored.
4. Press **SAVE** . If **INTRNL** is underlined, press **INTRNL CRD** to select **CRD** . Press **TRACE** -> **CARD** to access the menu that displays **TRACE A** , **TRACE B** , and **TRACE C** .
5. Press the softkey label of the trace that you want to save: **TRACE A** , **TRACE B** , or **TRACE C** . **REGISTER #** and **PREFIX=** are displayed on the analyzer display.
6. Use the numeric keypad to enter a register number and then press **ENTER** .

The trace data is saved with a file name consisting of a "t," the prefix that was entered, an underscore (-), and the register number. The "t" denotes that the file contains trace data.

### To Recall a Trace

1. Press **SAVE** or **RECALL** . If **INTRNL** is underlined, press **INTRNL CRD** to select **CRD** .
2. Press **CATALOG CARD** then **CATALOG TRACES** . Use the knob to highlight the trace data to be retrieved.
3. Press **LOAD FILE** . The trace data is placed in trace B.

Trace data can also be recalled by specifying the prefix and the register number:

1. Press **RECALL** . If **INTRNL** is underlined, press **INTRNL CRD** to select **CRD** .
2. Press **CARD** -> **TRACE** to access the menu that displays **TRACE A** , **TRACE B** , and **TRACE C** .
3. Select the trace in which you want the trace data stored by pressing **TRACE A** , **TRACE B** , or **TRACE C** .



4. Enter the register number that the trace was saved under and then press **ENTER**. The recalled trace is placed in view mode.

---

**Note** If you want to recall a trace saved under a different prefix, use **CHANGE PREFIX** to enter the prefix and then recall the trace.



---

### To Save Limit-Line Tables or Amplitude Correction Factors

The procedure for saving limit-line tables or amplitude correction factors is similar to saving trace data. State and trace data is not recalled when the limit-line tables or amplitude correction factors are recalled.

1. Press **DISPLAY** or **CONFIG**, **CHANGE PREFIX** to enter a new prefix or change the existing prefix.

---

**Note** If you do not enter a new prefix, the existing prefix will be used. If there is not an existing prefix, the limit-line table(s) will be saved under l\_(register number). Amplitude correction factors will be saved under a\_(register number).



2. When saving limit-line tables, set up the limit-line table to be stored (see “Using the Limit-Line Functions” in this chapter). When saving amplitude-correction factors, enter the data using the remote programming **AMPCOR** command or use the amplitude-correction function softkeys. See “Using Amplitude Correction Functions” in this chapter for more information about entering amplitude correction factors via the front-panel.
3. Press **SAVE**. If **INTRNL** is underlined, press **INTRNL CRD** to select **CRD**. Press **TRACE -> CARD** to access the menu with **LIMIT LINES** and **AMP COR**.
4. Press either **LIMIT LINES**, to save limit-line tables, or **AMP COR**, to save amplitude-correction factors. **REGISTER #** and **PREFIX=** are displayed on the analyzer display.
5. Use the numeric keypad to enter a register number and then press **ENTER**.

The data is saved with a file name consisting of a “l” (for limit-line tables) or “a” (for amplitude-correction factors), the prefix that was entered, an underscore (-), and the register number.

### To Recall Limit-Line Tables or Amplitude Correction Factors

1. press **RECALL**. If **INTRNL** is underlined, press **INTRNL CRD** to select **CRD**.
2. Press **CARD -> TRACE** to access the menu with **LIMIT LINES** and **AMP COR**.
3. Press either **LIMIT LINES**, to recall a limit-line tables, or **AMP COR**, to recall amplitude-correction factors.
4. Enter the register number that the limit-line data or amplitude-correction factors was saved under and then press **ENTER**.

---

**Note**

If you want to recall limit-line data or amplitude-correction factors saved under a different prefix, use **CHANGE PREFIX** to enter the prefix and then recall the trace.

---

**Note**

If **LOAD FILE** is used to recall limit-line files or amplitude-correction factor files, the traces are set to the store-blank mode. Press **TRACE**, **CLEAR WRITE A** to view trace A data.

---

## Saving and Recalling Programs with a Memory Card

Programs (also called downloadable programs or DLPs) can be loaded into analyzer memory either by loading a program from a memory card or by defining a function with remote programming commands (remote programming ability is available with Option 021 or 023).

The process of saving and recalling programs from the memory card is similar to saving state data. To save program information to the memory card use **ALL DLP -> CARD**.

---

**Note**

**ALL DLP -> CARD** saves an image of the analyzer memory. This means a program cannot be saved selectively if several programs are present in the analyzer memory at the time. Use **CATALOG INTRNL**, **DELETE FILE** to delete the items in user memory that you do not wish to be saved on the memory card. **ALL DLP -> CARD** saves all programs and key definitions that are in analyzer memory onto the memory card.

---

## To Save Programs

1. Press **CONFIG** or **DISPLAY**, then **CHANGE PREFIX** to enter a new prefix or change the existing prefix.

---

**Note**

If you do not enter a new prefix, the existing prefix will be used. If there is not an existing prefix, the program will be saved under d\_(register number).

---

2. Press **SAVE**. If **INTRNL** is underlined, press **INTRNL CRD** to select **CRD**.
3. Press **ALL DLP ->CARD**. **REGISTER #** and **PREFIX=** are displayed on the analyzer display.
4. Use the numeric keypad to enter a register number and then press **ENTER**.

The data is saved with a file name consisting of a "d," the prefix that was entered, an underscore (\_), and the register number. The "d" denotes that the file contains downloadable program data.

## To Recall Programs

1. Press **SAVE** or **RECALL**. If INTRNL is underlined, press **INTRNL CRD** to select CRD. (CRD is underlined when the memory card is selected).
2. Press **CATALOG CARD**, **MORE 1 of 2**, then **CATALOG DLP**. Use the knob to highlight the trace data to be retrieved.
3. Press **LOAD FILE**.

Programs can also be recalled by specifying the prefix and the register number:

1. Press **RECALL**. If INTRNL is underlined, press **INTRNL CRD** to select CRD.
2. Press **CARD -> DLP**, enter the register number that the program was saved under, and then press **ENTER**.

---

### Note



If you want to recall a program saved under a different prefix, use **CHANGE PREFIX** to enter the prefix and then recall the program.

---

Table 1-6 summarizes the functions when saving and recalling data to and from the memory card.

Table 1-6. Save and Recall Functions Using Memory Card

Operation	Screen Title Available?	Default File Name	Register Range	Key Sequence
save state	No	s(current prefix) -(register #)	Prefix + register # ≤ 8 characters	<b>(SAVE) STATE -&gt; CARD</b> (register #) <b>(ENTER)</b>
recall state	No	N/A	Prefix + register # ≤ 8 characters	<b>(RECALL) CARD -&gt;STATE</b> (register #) <b>(ENTER)*</b>
save trace	Yes	t(current prefix) -(register #)	Prefix + register # ≤ 8 characters	<b>(SAVE) TRACE -&gt; CARD</b> ( <b>TRACE A</b> , <b>TRACE B</b> , or <b>TRACE C</b> ) (register #) <b>(ENTER)</b>
recall trace	Yes	N/A	Prefix + register # ≤ 8 characters	<b>(RECALL) CARD -&gt;TRACE</b> ( <b>TRACE A</b> , <b>TRACE B</b> , or <b>TRACE C</b> ) (register #) <b>(ENTER)*</b>
save limit lines	No	l(current prefix) -(register #)	Prefix + register # ≤ 8 characters	<b>(SAVE) TRACE -&gt; CARD</b> <b>LIMIT LINES</b> (register #) <b>(ENTER)</b>
recall limit lines	No	N/A	Prefix + register # ≤ 8 characters	<b>(RECALL) CARD -&gt;TRACE</b> <b>LIMIT LINES</b> (register #) <b>(ENTER)</b>
save amplitude correction factors	No	a(current prefix) -(register #)	Prefix + register # ≤ 8 characters	<b>(SAVE) TRACE -&gt; CARD AMP COR</b> (register #) <b>(ENTER)</b>
recall amplitude correction factors	No	N/A	Prefix + register # ≤ 8 characters	<b>(RECALL) CARD -&gt;TRACE AMP COR</b> (register #) <b>(ENTER)</b>
save DLP	No	d(current prefix) -(register #)	Prefix + register # ≤ 8 characters	<b>(SAVE) ALL DLP -&gt;CARD</b> (register #) <b>(ENTER)</b>
recall DLP	No	N/A	Prefix + register # ≤ 8 characters	<b>(RECALL) CARD -&gt;DLP</b> (register #) <b>(ENTER)*</b>
* An alternate method for recalling a file uses the key sequence: <b>(RECALL)</b> , <b>CATALOG CARD</b> , <b>CATALOG ALL</b> , use the knob to highlight the desired file, then <b>LOAD FILE</b> .				

## Using Limit-Line Functions

Limit lines provide an easy way to compare trace data to a set of amplitude and frequency parameters while the spectrum analyzer is sweeping the measurement range. An upper and a lower limit line can be displayed. Every measurement sweep of trace A is compared to the limit lines. If trace A is at or within the bounds of the limit lines, **LIMIT PASS** is displayed. If trace A is out of the limit-line boundaries, **LIMIT FAIL** is displayed. Figure 1-8 shows a sample limit-line display.

This section provides an overview of limit lines, a procedure for creating an upper limit line, and descriptions of the limit-line functions. A procedure for creating an upper and a lower limit line is at the end of this section. Refer to Chapter 3 for more information on a specific limit-line function.

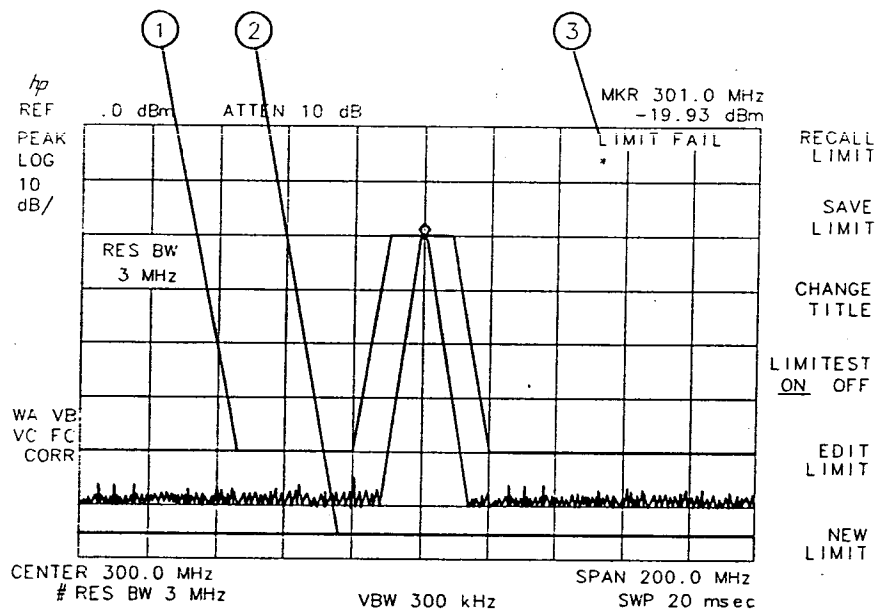

Figure 1-8. Typical Limit-Line Display

Item	Description
1	Upper limit line
2	Lower limit line
3	Screen message

### Procedure for Creating an Upper Limit Line

This procedure demonstrates how to create an upper limit line and activate testing. Detailed descriptions of the limit-line functions follow this procedure.

1. Press **PRESET**.
2. Set the center frequency and span by pressing **FREQUENCY**, 300 **MHz**, and **SPAN**, 500 **MHz**.

3. Connect the analyzer's CAL OUT and INPUT 50  $\Omega$  on the analyzer using an appropriate cable. (The calibration signal is used as the "test" signal for this demonstration.)

**Note**



If the amplitude units are anything other than dBm at this time, change the amplitude units to dBm for this demonstration. Press **AMPLITUDE**, **MORE 1 of 2**, **AMPTD UNITS**, **dBm**.

4. Press **MEAS/USER** to access the limit-line menus.
5. To clear an existing limit-line table, press **LIMIT LINES** and **NEW LIMIT** two times consecutively. Or, if no limit-line table exists or you wish to edit an existing limit-line table, press **LIMIT LINES**, **EDIT LIMIT**.

**Note**



After pressing **NEW LIMIT** the first time, the message **IF YOU ARE SURE, PRESS KEY AGAIN TO PURGE DATA** will appear. Pressing **NEW LIMIT** a second time clears the current limit-line table and displays the edit menu for limit lines.

6. Press **LIMITS FIX REL** so that **FIX** is underlined. **LIMITS FIX REL** specifies whether or not the limit line is relative to the analyzer's center frequency and reference-level settings.
7. Press **EDIT UPPER** to edit or create an upper limit line.
8. Specify the first limit-line segment to begin at 50 MHz and have an amplitude of -60 dBm by using the following key sequence:

```
SELECT SEGMENT 1 ENTER
SELECT FREQ 50 MHz
SELECT AMPLITUD 60 -dBm
SELECT TYPE FLAT
```

**Note**



The coordinates for the second point must be entered before the first and second limit-line segments are displayed.

9. Enter the second limit-line segment by using the following key sequence:

```
SELECT SEGMENT 2 ENTER
SELECT FREQ 250 MHz
SELECT AMPLITUD 60 -dBm
SELECT TYPE SLOPE
```

**Note**



Table entries can be edited if you make a mistake. To edit an existing segment, use **SELECT SEGMENT** to specify the segment, and **SELECT FREQ**, **SELECT AMPLITUD**, or **SELECT TYPE** to specify the column you wish to edit.

10. Specify the third limit-line segment by using the following key sequence:

```

SELECT SEGMENT 3 
SELECT FREQ 400 
SELECT AMPLITUD 15 
SELECT TYPE FLAT
  
```

You may notice that the end coordinate of segment three is drawn to a point off the top of the analyzer display. To avoid this, the frequency coordinate of the last segment should exceed the stop frequency of the analyzer display.

11. Specify the fourth limit-line segment by using the following key sequence:

```

SELECT SEGMENT 4 
SELECT FREQ 600 
SELECT AMPLITUD 15 
SELECT TYPE POINT
  
```

Since the limit line in this procedure has only four segments specified, the frequency value of segment four (the last segment) is set to 600 MHz, which is greater than the stop frequency of the display.

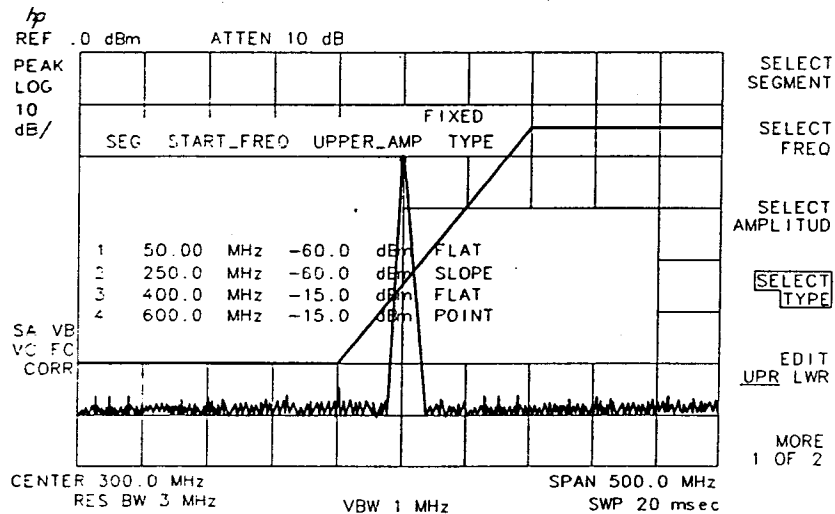

Figure 1-9. The Completed Limit-Line Table

12. Press MORE 1 of 2, then EDIT DONE when all the segments have been entered.

13. Press LIMITEST ON OFF so that ON is underlined. This turns the limit testing on. For example, LIMIT FAIL is displayed because the calibration signal exceeds the limit line.

14. Disconnect the CAL OUT from the analyzer INPUT 50Ω. LIMIT PASS is displayed since no signal exceeds the limit line.

## Limit-Line Functions

This section describes the limit-line functions in the order that they are usually used.

### Editing, Creating, or Viewing Limit-Line Tables

Pressing **MEAS/USER**, then **LIMIT LINES** accesses the softkey menus used for creating a limit line.

Pressing **NEW LIMIT** two times consecutively clears an existing limit-line table and accesses the limit-line editing menu.

#### Note



After pressing **NEW LIMIT** the first time, the message **IF YOU ARE SURE, PRESS KEY AGAIN TO PURGE DATA** will appear. Pressing **NEW LIMIT** a second time purges the limit-line table. **PURGE LIMITS** can also be used to clear an existing limit-line table in the same manner as **NEW LIMIT** (that is, pressing the softkey two times).

**PRESET** turns limit-line testing off (if it is on), but does not clear an existing limit-line table.

Press **EDIT LIMIT** instead of **NEW LIMIT** to edit an existing limit-line table or, if no limit-line table currently exists, to create a limit-line table.

### Selecting the Type of Limit-Line Table

Pressing **LIMITS FIX REL** selects the type of limit line. There are two types of limit lines: fixed and relative. Fixed limit lines contain only absolute amplitude and frequency values. Relative limit lines consist of frequency values that are referenced to the analyzer's center frequency and amplitude values that are relative to the analyzer's reference level. For example, if a limit line is specified as fixed, entering a limit-line segment with a frequency coordinate of 300 MHz displays the limit-line segment at 300 MHz. If the same limit-line table is specified as relative, it is displayed relative to the analyzer's center frequency and reference level. If the center frequency is at 1.2 GHz, a relative limit-line segment with a frequency coordinate of 300 MHz will display the limit-line segment at 1.5 GHz. If the amplitude component of the relative limit-line segment is -10 dB, then -10 dB is added to the reference-level value to obtain the amplitude of the given component.

**RELATIVE** is displayed in the limit-line table when the limit-line type is relative; **FIXED** is displayed when the limit-line type is fixed.

A limit line entered as fixed may be changed to relative, and one entered as relative may be changed to fixed. When the limit-line type is changed, the frequency and amplitude values in the limit-line table will change to keep the limit line in the same position for the current frequency and amplitude settings of the spectrum analyzer.

### Selecting the Limit-Line Table Format

Press **EDIT UPPER**, **EDIT LOWER**, **EDIT UP/LOW**, or **EDIT MID/DELT** to edit or create a limit-line table. Each of the edit softkeys represents a different type of limit-line table format. The choice of edit softkey depends upon whether you want an upper limit line only, a lower limit line only, both an upper and a lower limit line, or the characteristics of the limit line being entered.



The four limit-line table formats are described below:

- The upper limit-line table format is accessed by **EDIT UPPER**. With the upper limit-line table format, the coordinates of only the upper limit line are specified; lower limit-line coordinates are not specified. Even if lower limit-line values exist or the values had been entered as an upper and lower limit-line table, the upper limit-line values are treated as a separate table from the lower limit-line values. Upper limit-line entries can have independent frequency and amplitude coordinates from lower limit-line table entries.
- The lower limit-line table format is accessed by **EDIT LOWER**. With the lower limit-line table format, the coordinates of only the lower limit line are specified; upper limit-line coordinates are not specified. Even if upper limit-line values exist or the values had been entered as an upper and lower limit-line table, the lower limit-line values are treated as a separate table from the upper limit-line values. Lower limit-line entries can have independent frequency and amplitude coordinates from upper limit-line table entries.
- The upper and lower limit-line table format is accessed by **EDIT UP/LOW**. With the upper and lower limit-line table format, the upper and lower limit-line coordinates can be entered at the same time: the frequency, upper amplitude, lower amplitude, and type are specified. The frequency and upper amplitude comprise the coordinate point for the upper limit line; the frequency and lower amplitude value comprise the coordinate point for the lower limit line. It is not necessary to specify both an upper- and lower-amplitude component for every frequency component. Three asterisks in the table indicate that an amplitude value has not been entered for the segment.
- The mid/delta limit-line table format is accessed by **EDIT MID/DELT**. Like the upper and lower limit-line table format, the mid/delta limit-line table format provides a means of specifying the upper and lower limit lines at the same time. Unlike the upper and lower table format, the amplitude values are specified as a middle amplitude value with a delta: the upper and lower limit lines are then drawn at an equal positive and negative distance from the middle amplitude. With the mid/delta format, the frequency and the mid-amplitude plus the delta comprise the upper limit line; the frequency and the mid-amplitude minus the delta comprise the lower limit line. The difference between the mid/delta format and the upper/lower format is the way the amplitude values are entered; however, in both formats, the frequency coordinate begins a segment. The mid/delta format can be used if the upper and lower limit lines are symmetrical with respect to the amplitude axis.

---

**Note**

Regardless of which limit-line table format is used to enter the limit-line values, it is possible to edit the same limit-line values with any of the formats.



---

### Selecting the Segment Number

Pressing **SELECT SEGMENT** specifies the segment number to be entered or edited. Limit lines are created by entering frequency and amplitude values into a limit-line table. The frequency and amplitude values specify a coordinate point from which a limit-line segment is drawn. The coordinate point is the lowest frequency point of the line segment. Limit lines are constructed from left to right. See Figure 1-10.

**Note**



Up to 20 segments can be specified for an upper or lower limit-line table.

When entering a limit-line segment, the frequency and amplitude values will be listed as asterisks (\*\*\*) until new values are entered. The new segment will be listed last until both the frequency and the amplitude values have been entered. Once the frequency and at least one amplitude value are entered, the segment will be sorted into the limit-line table according to frequency.

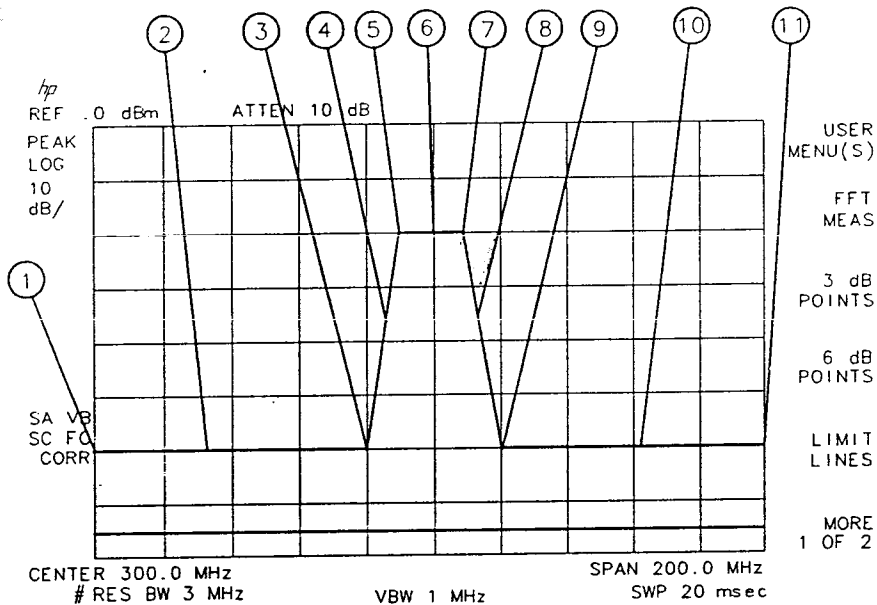

**Figure 1-10. Limit-Line Segments**

Item	Description
1	Frequency and amplitude coordinate that starts the first segment.
2	First segment.
3	Frequency and amplitude coordinate that starts the second segment.
4	Second segment.
5	Frequency and amplitude coordinate that starts the third segment.
6	Third segment.
7	Frequency and amplitude coordinate that starts the fourth segment.
8	Fourth segment.
9	Frequency and amplitude coordinate that starts the fifth segment.
10	Fifth segment.
11	Frequency and amplitude coordinate that starts the sixth segment.

### Selecting the Frequency Coordinate

Press **SELECT FREQ** , then enter a frequency value for the segment. Regardless of the table format, a frequency coordinate must be specified.

---

#### Note



There can be only one entry per frequency. Entering two segments with the same frequency in the same limit-line table overwrites the first entry.

When entering the frequency coordinates for a vertical line segment, the second frequency value needs to be 1 Hz greater than the first frequency value. This will prevent the first frequency value from being overwritten.

---

### Selecting the Amplitude Coordinate

In the previous procedure, pressing **SELECT AMPLITUD** and then entering an amplitude value, specified the amplitude coordinate for the upper limit line. The limit-line table formats dictate how the amplitude values are treated:

- With the upper limit-line table format, one amplitude component (representing an upper limit-line segment) is specified per frequency component. The amplitude value is entered by pressing **SELECT AMPLITUD** , entering an amplitude value, and pressing a units key.
- With the lower limit-line table format, one amplitude component (representing a lower limit-line segment) is specified per frequency component. The amplitude value is entered by pressing **SELECT AMPLITUD** , entering an amplitude value, and pressing a units key.
- With the upper/lower limit-line table format, two amplitude components (one representing an upper limit-line segment and one representing a lower limit-line segment) can be specified per frequency component. It is not necessary to specify both an upper and a lower amplitude value. For example, specifying only upper amplitude values results in an upper limit line, but not a lower limit line. The amplitude of the upper limit line is entered by pressing **SELECT UPR AMPL** , entering an amplitude value, and pressing a units key. The amplitude of the lower limit line is entered by pressing **SELECT LWR AMPL** , entering an amplitude value, and pressing a units key.
- With the mid/delta limit-line table format, two amplitude components (one representing a mid-amplitude value, one representing a deviation [positive and negative values] from either side of this value) is specified per frequency component. If no deviation is entered, the deviation defaults to zero. The middle amplitude value is entered by pressing **SELECT MID AMPL** , entering an amplitude value, and pressing a units key. The deviation is entered by pressing **SELECT DLT AMPL** , entering an amplitude value, and pressing a units key.

---

#### Note



Frequency or amplitude values that are not within the limit-line range will be modified. For example, a frequency value of 60 GHz will be modified to 30 GHz.

---

## Selecting the Segment Type

Press **SEGMENT TYPE**, then **FLAT**, **SLOPE**, or **POINT** to specify the segment type. The segment type determines how to connect the coordinate point of the current line segment with the coordinate point of the next line segment. The segment type determines whether the line segment is horizontal or vertical, sloped, or a single point. The three segment types are:

- Flat draws a zero-slope line between the coordinate point of the current segment and the coordinate point of the next segment, producing limit-line values equal in amplitude for all frequencies between the two points. If the amplitude values of the two segments differ, the limit-line will “step” to the value of the second segment. See Figure 1-11.
- Slope draws a straight line between the coordinate point of the current segment and the coordinate point of the next segment, producing limit-line values for all frequencies between the two points.
- Point specifies a limit value for the coordinate point, and no other frequency points, so that a point segment specifies a limit value for a single frequency. For an upper limit line, a point segment is indicated by a line drawn from the coordinate point, vertically off the top of screen. For a lower limit line, a point segment is indicated by a line drawn from the coordinate point, vertically off the bottom of screen. The point segment type should be used as the last segment in the limit-line table. However, if the last segment in the table is not specified as the point segment type, an implicit point is automatically used. If a visible point segment at the right-hand edge of the display is not desired, add an explicit last point segment to the limit-line table that is higher in frequency than the stop frequency.

Figure 1-11 demonstrates the different segment types.

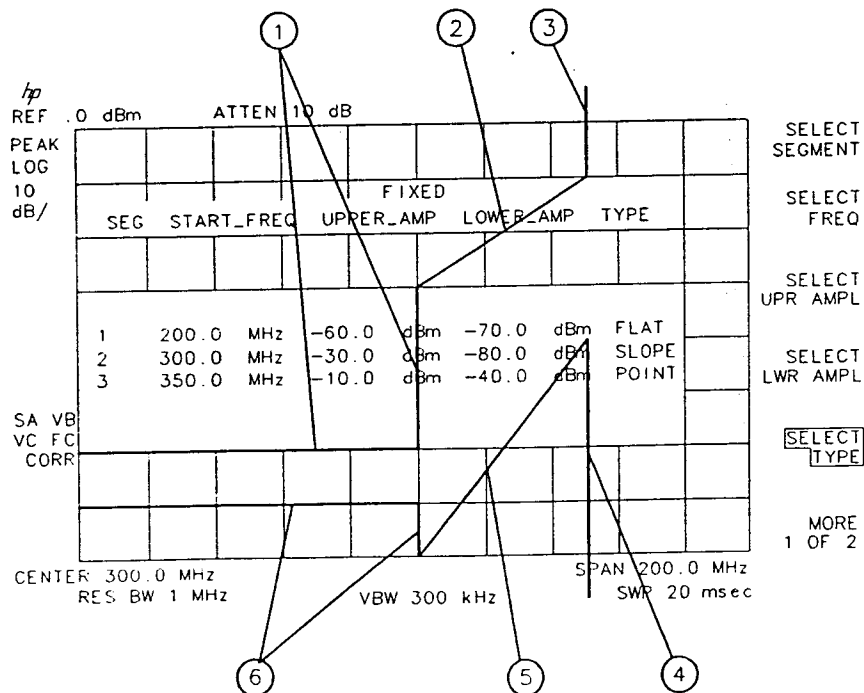

Figure 1-11. Segment Types

Item	Segment Types
1	Flat (upper limit line)
2	Slope (upper limit line)
3	Point (upper limit line)
4	Point (lower limit line)
5	Slope (lower limit line)
6	Flat (lower limit line)

### Completing Table Entry and Activating Limit-Line Testing

Pressing **EDIT DONE** blanks the limit-line table from the screen and accesses the menu with **LIMITEST ON OFF**.

Pressing **LIMITEST ON OFF** turns the limit-line testing on and off.

### Saving or Recalling Limit-Line Tables

Pressing **MEAS/USER** then **LIMIT LINES** accesses **SAVE LIMIT** and **RECALL LIMIT**. These softkey functions provide an easy way to save or recall current limit-line tables. **SAVE LIMIT** saves the current limit-line tables in the current mass storage device (either analyzer memory or a memory card). To verify the current mass storage device, press **SAVE LIMIT**. If **MAX REG #** appears on the analyzer display, the current mass storage device is analyzer memory. If **PREFIX=** is displayed, the memory card is the mass storage device. (Press **SAVE** or **RECALL**, then **INTRNL CRD** to change the current mass storage device.) Press **SAVE LIMIT**, enter a register number, then press **ENTER** to save the current limit-line table in analyzer memory or on the memory card.

**RECALL LIMIT** recalls limit-line tables from the current mass storage device (either analyzer memory or a memory card). To verify the current mass storage device, press **RECALL LIMIT**. If **MAX REG #** appears on the analyzer display, the current mass storage device is analyzer memory. If **PREFIX=** is displayed, the memory card is the mass storage device. (Press **SAVE** or **RECALL**, then **INTRNL CRD** to change the current mass storage device.) To recall a limit line, enter the register number that the limit-line table was saved under, then press **ENTER**. When recalling a limit line from the memory card, it may be necessary to change the current prefix to the prefix that the limit line was stored with. Use **CHANGE PREFIX** to change the current prefix.

### Procedure for Creating an Upper and Lower Limit Line

This is a basic procedure for creating an upper and lower limit lines.

1. Press **PRESET**.
2. Since this procedure uses the calibration signal as the test signal, connect the analyzer's **CAL OUT** to the **INPUT 50 Ω** with an appropriate cable.
3. Set the analyzer controls as follows:

**FREQUENCY** 300 **MHz**  
**SPAN** 50 **MHz**  
**BW** 3 **MHz**

4. Press **MEAS/USER** to access the limit-line menus.
5. To clear an existing limit-line table, press **LIMIT LINES** , **NEW LIMIT** , **NEW LIMIT** .  
Or, use **SAVE LIMIT** to save the current limit-line table in the current mass storage device before clearing the limit-line table. To save the current limit-line table, press **SAVE LIMIT** , enter the register number, then press **ENTER** . Or, if no limit-line table exists and you wish to edit an existing limit-line table, press **LIMIT LINES** , then **EDIT LIMIT** .
6. Press **LIMITS FIX REL** so that **FIX** is underlined (fixed type of limit line).
7. Press **EDIT UP/LOW** to create upper and lower limit lines simultaneously.
8. Specify the first limit-line segment by using the following key sequence:

```

SELECT SEGMENT 1 ENTER
SELECT FREQ 275 MHz
SELECT UPR AMPL 60 -dBm
SELECT LWR AMPL 75 -dBm
SELECT TYPE FLAT

```

9. Repeat step 8 for the values listed in the following table to complete the limit-line table. To edit an existing segment, use **SELECT SEGMENT** to specify the segment and **SELECT FREQ** , **SELECT AMPLITUDE** , or **SELECT TYPE** to specify the column that you wish to edit.

Segment Number	Frequency	Upper Amplitude	Lower Amplitude	Type
2	290 MHz	-60 dBm	-75 dBm	Slope
3	295 MHz	-15 dBm	-75 dBm	Slope
4	297 MHz	-15 dBm	-75 dBm	Slope
5	300 MHz	-15 dBm	-29 dBm	Slope
6	303 MHz	-15 dBm	-75 dBm	Slope
7	305 MHz	-15 dBm	-75 dBm	Slope
8	310 MHz	-60 dBm	-75 dBm	Flat
9	400 MHz	-60 dBm	-75 dBm	Point

#### Note



When entering a limit-line segment, the frequency, and amplitude values will be listed as asterisks (\*\*\*) until new values are entered. The new segment will be listed last until both the frequency and amplitude values have been entered. Once the frequency and at least one amplitude value are entered, the segment will be sorted into the limit-line table according to frequency.

10. Press **MORE 1 of 2** , then **EDIT DONE** when all values have been entered into the limit-line table.

#### 1-40 Basic Operation

- Press **LIMITEST ON OFF** so that **ON** is underlined. **LIMIT PASS** is displayed on the analyzer screen if the measurement sweep is within the limit lines. **LIMIT FAIL** is displayed if the measurement sweep is not within the limit lines.

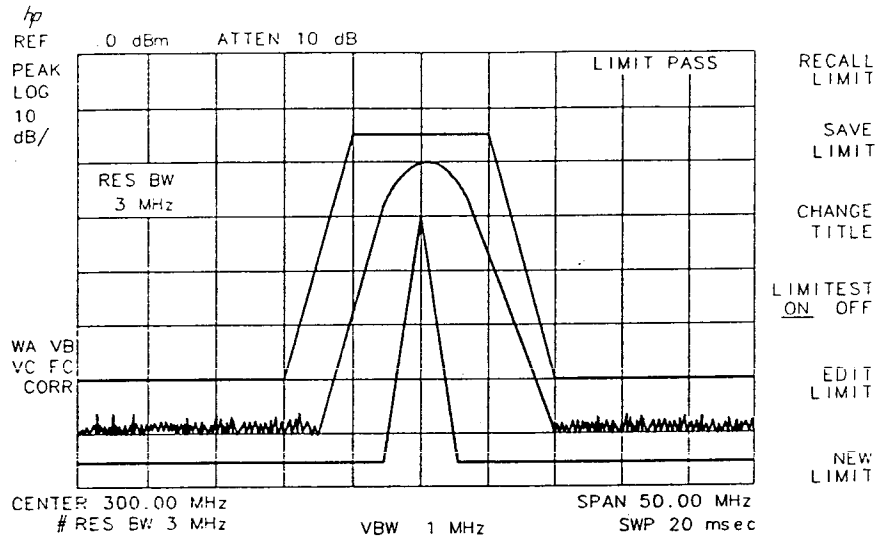

**Figure 1-12. Upper and Lower Limit-Line Testing**

To turn the limit-line testing on and off, use **LIMITEST ON OFF**. Use **NEW LIMIT** or **PURGE LIMITS** to clear the limit-line tables. To remove the limit lines from the display, use **BLANK B** to blank the upper limit line or **BLANK C** to blank the lower limit line.

## Using Amplitude Correction Functions

This section provides an overview of amplitude correction, a procedure for creating amplitude-correction data, and descriptions of the amplitude-correction functions. Refer to "Analyzer Functions" in Chapter 3 for more information on a specific amplitude-correction function.

Amplitude corrections provide an easy way to adjust trace data with a set of amplitude and frequency parameters while the spectrum analyzer is sweeping the measurement range. Every measurement sweep of data is adjusted by the amplitude-correction values. When using the amplitude-correction functions, an **A** is displayed at the left-hand side of the graticule edge.

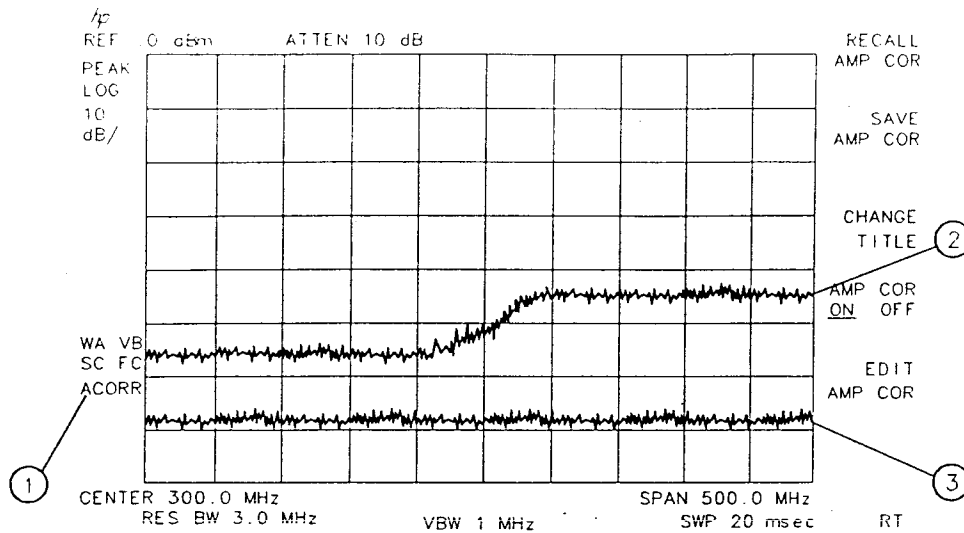

Figure 1-13. Amplitude-Correction Display

Item	Description
1	Indicates amplitude-correction factors are on.
2	Amplitude corrections ON.
3	Amplitude corrections OFF.

### Procedure for Creating Amplitude-Correction Factors

This procedure demonstrates how to create and activate amplitude-correction data. Detailed descriptions of the amplitude-correction functions follow this procedure.

1. Press **PRESET**.

**Note** A signal is not used in this procedure for demonstrating how to create amplitude-correction data.



2. Set the center frequency to 300 MHz, the span to 500 MHz by pressing **FREQUENCY**, 300 **MHz**, and **SPAN**, 500 **MHz**.
3. Press **MEAS/USER**, **MORE 1 of 3**, **MORE 2 of 3**, then **AMP COR** to access the amplitude-correction menus.
4. Press **EDIT AMP COR** to access the editing menus for amplitude-correction factors.
5. To clear any existing amplitude-correction data, press **PURGE AMP COR** two times consecutively.



---

**Note**

After pressing PURGE AMP COR the first time, the message IF YOU ARE SURE, PRESS KEY AGAIN TO PURGE DATA will appear. Pressing PURGE AMP COR a second time erases the amplitude-correction data.

---

6. Specify the first amplitude-correction point by using the following key sequence:

SELECT POINT 1 **ENTER**  
SELECT FREQ 50 **MHz**  
SELECT AMPLITUD 12 **+dBm**

7. Specify the second amplitude-correction point by using the following key sequence:

SELECT POINT 2 **ENTER**  
SELECT FREQ 250 **MHz**  
SELECT AMPLITUD 10 **+dBm**

---

**Note**

Table entries can be edited if you make a mistake. To edit an existing point, use SELECT POINT to specify the point, then SELECT FREQ or SELECT AMPLITUD to specify the entry that you wish to edit.

---

8. Specify the third and fourth amplitude-correction points by using the following key sequence:

SELECT POINT 3 **ENTER**  
SELECT FREQ 300 **MHz**  
SELECT AMPLITUD 15 **+dBm**  
SELECT POINT 4 **ENTER**  
SELECT FREQ 350 **MHz**  
SELECT AMPLITUD 22 **+dBm**

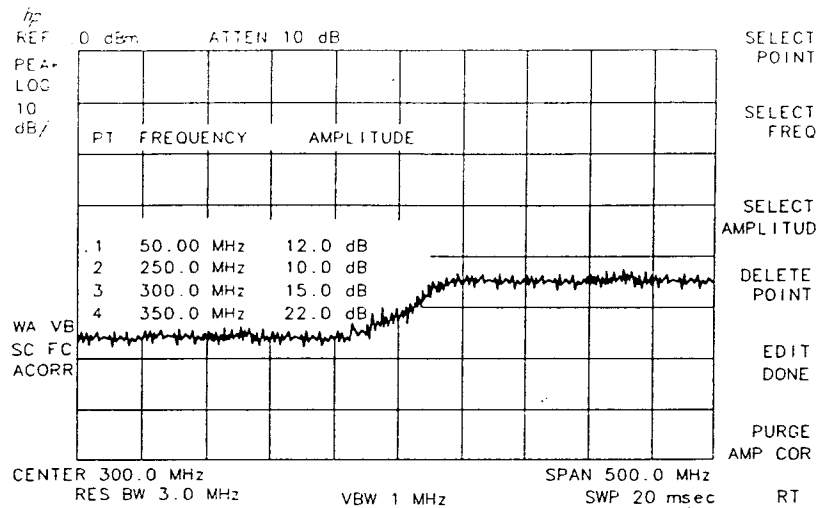

Figure 1-14. Completed Amplitude-Correction Table

9. Press **EDIT DONE** when all the points have been entered.

Use steps 10 and 11 to display corrected versus uncorrected amplitude trace data for trace comparison.

10. Display the amplitude-corrected trace in trace A by pressing the following keys:

**TRACE**  
**CLEAR WRITE A**  
**VIEW A**

11. Display the uncorrected amplitude trace in trace B by pressing the following keys:

**TRACE A B C** until B is selected  
**CLEAR WRITE B**  
**MEAS/USER**, **MORE 1 of 3**, **MORE 2 of 3**, **AMP COR**  
**AMP COR ON OFF** until OFF is selected

## Amplitude-Correction Functions

This section describes the amplitude-correction functions in the order they are usually used.

### Editing or Viewing the Amplitude-Correction Tables

Pressing **MEAS/USER**, **MORE 1 of 3**, **MORE 2 of 3**, then **AMP COR** accesses the softkey menus for creating an amplitude-correction table.

#### Note



**PRESET** turns amplitude-correction factors off (if it is on), but does not clear an existing amplitude-correction table. Use **PURGE AMP COR** to clear an existing amplitude-correction table.

Pressing **PURGE AMP COR** two times consecutively clears an existing amplitude-correction table.

Press **EDIT AMP COR** to edit an existing amplitude-correction table or, if no amplitude-correction table currently exists, to create an amplitude-correction table.

### Selecting the Amplitude-Correction Point

Pressing **SELECT POINT** specifies the amplitude-correction point to be entered or edited. Amplitude-correction data is constructed from left to right and is created by entering frequency and amplitude values into an amplitude-correction table. The frequency and amplitude values specify a coordinate point from which amplitude-corrections are interpolated. See Figure 1-15. Up to 79 points can be specified for the amplitude-corrections table.

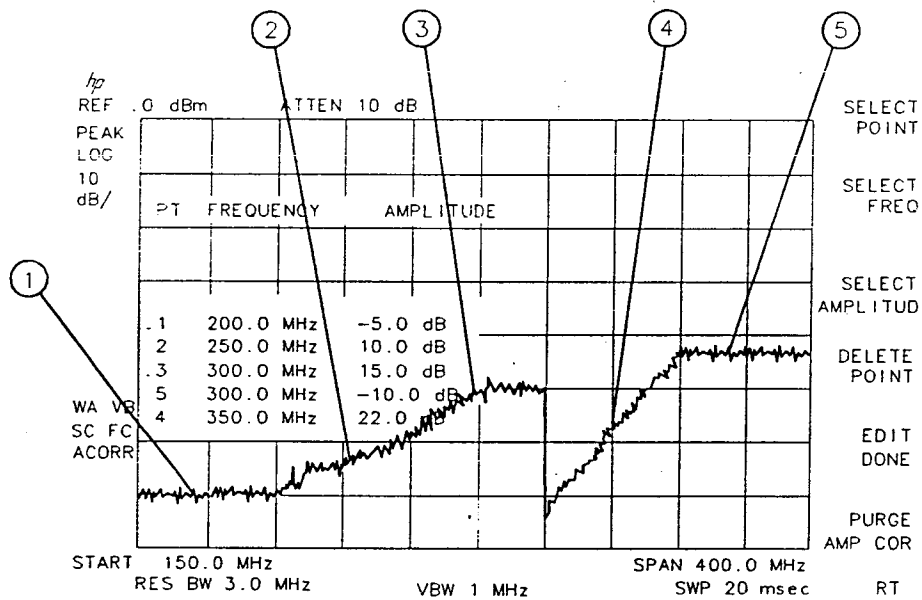

**Figure 1-15. Amplitude-Correction Points**

Item	Description
1	Frequencies below first point use first amplitude level.
2	First segment interpolated.
3	Frequency and amplitude coordinate that starts the second segment.
4	Second segment.
5	Frequency and amplitude coordinate that starts the third segment.

### Selecting the Frequency Coordinate

Press **SELECT FREQ**, then enter a frequency value for the point.

---

**Note**

Only two entries per frequency are used. If more points with the same frequency are entered, only the first and last entries are used. All other amplitude values are ignored. See Figure 1-15.

---

**Note**

When entering amplitude-correction data, the frequency and amplitude values will be listed as asterisks (\*\*\*) until new values are entered. Once the frequency value is entered, the segment is immediately sorted into the table according to this value.

---

**Selecting the Amplitude Coordinate**

In the previous procedure, pressing **SELECT AMPLITUD** then entering an amplitude value specified the amplitude coordinate for the point. The amplitude value is entered by pressing **SELECT AMPLITUD**, entering an amplitude value, and pressing a units key.

---

**Note**

Frequency or amplitude values that are not within range will be modified. For example, a frequency value of 60 GHz will be modified to 30 GHz.

---

**Completing Table Entry and Activating Amplitude Corrections**

Pressing **EDIT DONE** blanks the amplitude-correction table from the screen and accesses the menu with **AMP COR ON OFF**.

Pressing **AMP COR ON OFF** turns the amplitude corrections on and off.

**Saving or Recalling Amplitude Correction Tables**

Pressing **AMP COR** under the **(MEAS/USER)** key accesses **SAVE AMP COR** and **RECALL AMP COR**. These softkey functions provide an easy way to save or recall current amplitude-correction tables. **SAVE AMP COR** saves the current amplitude-correction table in the current mass storage device (analyzer memory or memory card). To verify the current mass storage device, press **SAVE AMP COR**. If **MAX REG #** appears on the analyzer display, the current mass storage device is analyzer memory. If **PREFIX=** is displayed, the memory card is the mass storage device. (Press **(SAVE)** or **(RECALL)**, **INTRNL CRD** to change the current mass storage device.) Press **SAVE AMP COR**, enter a register number, then press **(ENTER)** to save the current amplitude-correction table in analyzer memory or on the memory card.

**RECALL AMP COR** recalls amplitude-correction tables from the current mass storage device (analyzer memory or memory card). To verify the current mass storage device, press **RECALL AMP COR**. If **MAX REG #** appears on the analyzer display, the current mass storage device is analyzer memory. If **PREFIX=** is displayed, the memory card is the mass storage device. (Press **(SAVE)** or **(RECALL)**, **INTRNL CRD** to change the current mass storage device.) To recall an amplitude-correction table, enter the register number that the table was saved under, then press **(ENTER)**. When recalling an amplitude-correction table from the memory card, it may be necessary to change the current prefix to the prefix that the table was originally stored with. Use **CHANGE PREFIX** to change the current prefix.

## External Keyboard

The HP C1405A Option ABA Keyboard is an IBM AT compatible keyboard that can be connected to the external keyboard connector on the rear panel of the analyzer. The external keyboard allows a convenient way to enter screen titles and remote programming commands directly into the spectrum analyzer or to access the softkey functions.





The external keyboard connector (located on the rear panel of the spectrum analyzer) is available with Option 021 or 023. These options provide the capability to control your analyzer from a computer that uses either an HP-IB (Option 021) or RS-232 (Option 023) interface bus.

The function keys of the external keyboard control the analyzer as follows:

**Table 1-8. External Keyboard Functions**

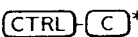
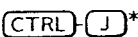
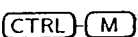
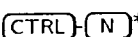
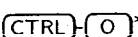
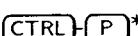
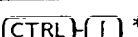

Key	Description
F1—F6	Softkeys 1 through 6 (respectively) of the current analyzer menu.
F7	Enter prefix mode.
F8	Enter remote commands mode.
F9	Accesses the <b>FREQUENCY</b> menu.
F10	Accesses the <b>SPAN</b> menu.
F11	Accesses the <b>AMPLITUDE</b> menu.
F12	Retrieves the present screen title for editing.
<b>ESC</b>	Returns to the enter title mode.
<b>PRINT SCREEN</b>	Copies the analyzer screen display to the active copy device.
<b>DELETE</b>	Deletes the character over the cursor.
<b>INSERT</b>	Toggles between the insert and replace mode at the cursor.
<b>BACKSPACE</b>	Erases the previous character to the left of the cursor.
<b>ALT-DELETE</b> *	Clears the keyboard line.
<b>CTRL-DELETE</b> *	Clears to end of line.

Table 1-8. External Keyboard Functions (continued)

Key	Description
	Moves the cursor to the left.
	Moves the cursor to the right.
	Moves from later items to earlier items in the recall buffer.
	Moves from earlier items to later items in the recall buffer.
 *	End-of-text.
 *	Line feed.
 *	Carriage return.
 *	Turns on inverse video.
 *	Turns enhancements (inverse video, underlining) off.
 *	Turns off underlining.
 *	Escape.
*The dash between keys indicates that both keys should be pressed at the same time.	

The external keyboard operation with the analyzer is similar to its operation with a computer except for the following:

SCROLL LOCK and NUM LOCK are fixed and cannot be changed. Pressing  displays the keyboard mode on the analyzer screen. The analyzer will not recognize the control characters or function keys.

The keyboard supports a 244 character recall buffer. The longest single item is limited to 243 characters; subsequent characters are ignored. Using the  or  keys of the external keyboard to recall an item does not change the buffer contents. Recalling an item and then pressing the  key does not store a new copy of the item in the recall buffer. If an item is recalled and then modified, a new copy will be made in the recall buffer. Adding new data into the keyboard line deletes the oldest data automatically.

When in command mode, the active line will append a semicolon to the keyboard entry if the line does not end with a semicolon and it is fewer than 243 characters long.

### Using the External Keyboard

The following three example procedures demonstrate how to use an external keyboard to enter a screen title, programming commands, and a prefix. However, a brief procedure on installing your external keyboard is described first.

#### External Keyboard Installation

##### Caution



The analyzer *must* be turned off before connecting an external keyboard to the spectrum analyzer. Failure to do so may result in loss of factory-installed correction constants.

1. Turn off the spectrum analyzer.
2. Connect an HP C1405 Option 002 (or Option 003) cable from the spectrum-analyzer rear-panel connector EXT KEYBOARD to the HP C1405A Option ABA Keyboard.
3. Press **LINE** to turn the spectrum analyzer on.
4. The external keyboard is now ready to use for entering a screen title, programming commands, or a prefix.

#### To Enter a Screen Title

1. Type in a screen title using the external keyboard. The entry appears at the top line of the analyzer display as it is entered.
2. Press **ENTER** on the external keyboard. Pressing **ENTER** moves the characters to the position on the display for screen title annotation.

---

#### Note



To view more than 31 characters per line, turn off the time and date display by pressing the following keys: **CONFIG**, **TIMEDATE**, **TIMEDATE ON OFF** (OFF).

---

#### To Enter Programming Commands

1. Press **F8** on the external keyboard to enter the mode for executing remote commands.
2. Type in a programming command (for example, type IP).
3. Press **ENTER** on the external keyboard to execute the command.

---

#### Note



Unlike entering a remote programming command using an external controller, entering the remote programming commands with the external keyboard does not require including the analyzer address. It is also not necessary to terminate the programming line with a semicolon. However, semicolons are necessary for separating the programming commands. For example, a program line is entered via the external controller as: OUTPUT 718;"CF 300MHZ;SP 1MHZ;". The same program line is entered using the external keyboard as: CF 300MHZ;SP 1MHZ **ENTER**.

---

After **F8** is pressed, the analyzer remains in command mode. To return to the title entry mode, press **PRESET** (on the analyzer) or **ESC** (on the external keyboard).

#### To Enter a Prefix

1. Press **F7** on the external keyboard to enter the mode for entering a prefix.
2. Type in the prefix.
3. Press **ENTER** on the external keyboard.







## Analyzer Measurements and Applications

---

### What You'll Learn in This Chapter

This chapter demonstrates analyzer measurement techniques with examples of typical applications; each application focuses on different features. The measurement procedures covered in this chapter are listed below.

- Resolving signals of equal amplitude using the resolution bandwidth function.
- Resolving small signals hidden by large signals using the resolution bandwidth function.
- Increasing the frequency readout resolution using the marker counter (HP 8591A, HP 8593A, HP 8594A, or HP 8595A only).
- Decreasing the frequency span using the signal track function.
- Peaking signal amplitude using preselector peak (HP 8592B, HP 8593A, or HP 8595A only).
- Tracking unstable signals using signal track and the maximum hold and minimum hold functions.
- Comparing signals using delta markers.
- Measuring low-level signals using attenuation, video bandwidth, and video averaging.
- Identifying distortion products using the RF attenuator and traces.
- Using the spectrum analyzer as a receiver in zero frequency span.
- Measuring amplitude modulation using the fast Fourier transform function.
- Measuring signals near band boundaries using harmonic lock (HP 8592B and HP 8593A, or HP 8595A only).
- Using the comb generator to perform more accurate frequency measurements (HP 8592B only).
- Stimulus-response measurements using the built-in tracking generator (Option 010 or 011).
- Demodulating and listening to an AM or FM signal (Option 102 or 103 only).
- Triggering on a selected line of a video picture field (Options 101 and 102 or Option 301 only).
- Making a reflection calibration and measurements.
- Using the time-gated spectrum analyzer capability (Option 105 only).

To find descriptions of specific analyzer functions refer to Chapter 3, "Analyzer Functions".

## Resolving Signals of Equal Amplitude Using the Resolution Bandwidth Function

In responding to a continuous-wave signal, a swept-tuned spectrum analyzer traces out the shape of the spectrum analyzer's intermediate frequency (IF) filters. As we change the filter bandwidth, we change the width of the displayed response. If a wide filter is used and two equal-amplitude input signals are close enough in frequency, then the two signals appear as one. Thus, signal resolution is determined by the IF filters inside the spectrum analyzer.

The resolution bandwidth (RES BW) function selects an IF filter setting for a measurement. Resolution bandwidth is defined as the 3 dB bandwidth of the filter. The 3 dB bandwidth tells us how close together equal amplitude signals can be and still be distinguished from each other.

Generally, to resolve two signals of equal amplitude, the resolution bandwidth must be less than or equal to the frequency separation of the two signals. A dip of approximately 3 dB is seen between the peaks of the two equal signals, and it is clear that more than one signal is present. See Figure 2-2.

In order to keep the analyzer calibrated, sweep time is automatically set to a value that is inversely proportional to the square of the resolution bandwidth. So, if the resolution bandwidth is reduced by a factor of 10, the sweep time is increased by a factor of 100 when sweep time and bandwidth settings are coupled. (Sweep time is proportional to  $1/BW^2$ .) For fastest measurement times, use the widest resolution bandwidth that still permits discrimination of all desired signals. The analyzer allows you to select from 1 kHz to 3 MHz resolution bandwidth in a 1, 3, 10 sequence, plus 5 MHz, for maximum measurement flexibility.

**Example:** Resolve two signals of equal amplitude with a frequency separation of 100 kHz.

1. To obtain two signals with a 100 kHz separation, connect the calibration signal and a signal source to the analyzer input as shown in Figure 2-1. (If available, two sources can be used.)

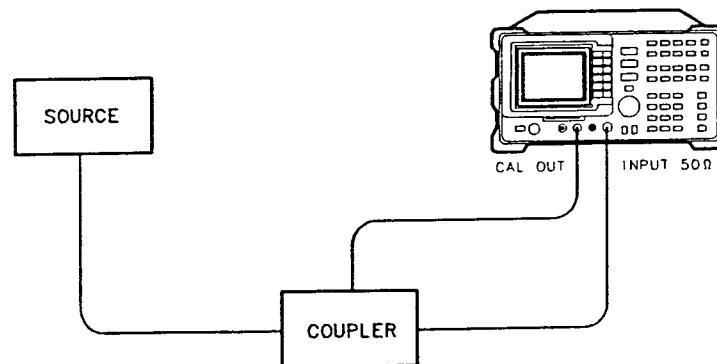

**Figure 2-1. Set-Up for Obtaining Two Signals**

2. If you are using the 300 MHz calibration signal, set the frequency of the source 100 kHz greater than the calibration signal (that is, 300.1 MHz). The amplitude of both signals should be approximately  $-20$  dBm.

### 2-2 Analyzer Measurements and Applications

- On the analyzer, press **PRESET**. Set the center frequency to 300 MHz, the span to 2 MHz, and the resolution bandwidth to 300 kHz: press **FREQUENCY** 300 **MHz**, **SPAN** 2 **MHz**, **BW** 300 **kHz**. A single signal peak is visible.

**Note**



When using an HP 8590B or HP 8592B and the signal peak cannot be found, increase the span to 20 MHz by pressing **SPAN** 20 **MHz**. The signal should be visible. Press **PEAK SEARCH**, **SIGNAL TRACK**, then **SPAN** 2 **MHz** to bring the signal to center screen. Press **SIGNAL TRACK** to turn the signal track function off.

- Since the resolution bandwidth must be less than or equal to the frequency separation of the two signals, a resolution bandwidth of 100 kHz must be used. Change the resolution bandwidth to 100 kHz by pressing **BW** 100 **kHz**. Two signals are now visible as in Figure 2-2. Use the knob or step keys to further reduce the resolution bandwidth and better resolve the signals.

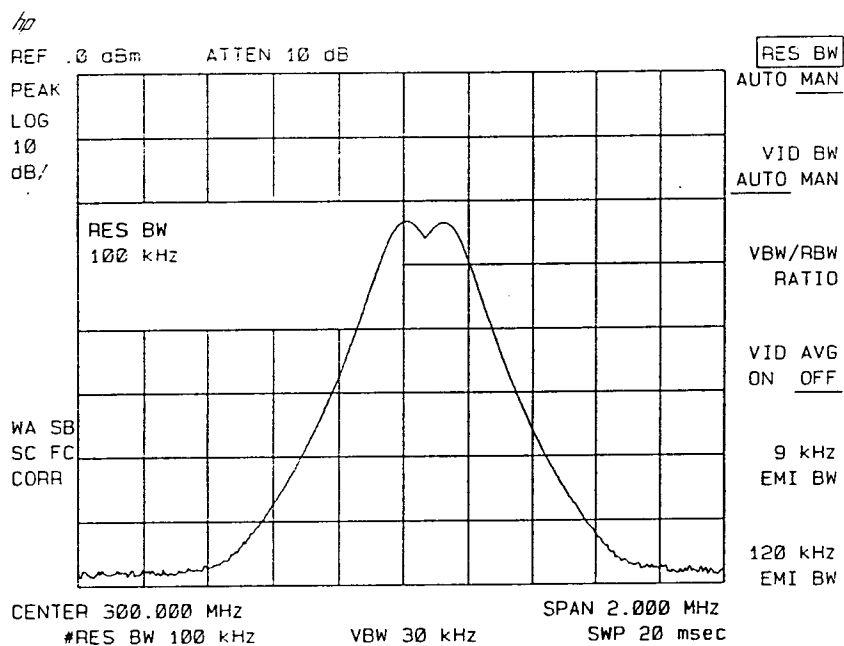

**Figure 2-2. Resolving Signals of Equal Amplitude**

As the resolution bandwidth is decreased, resolution of the individual signal is improved and the sweep time is increased. For fastest measurement times, use the widest possible resolution bandwidth. Under preset conditions, the resolution bandwidth is “coupled” (or linked) to span.

Since the resolution bandwidth has been changed from the coupled value, a “#” mark appears next to RES BW in the lower-left corner of the screen, indicating that the resolution bandwidth is uncoupled. (Also see the **AUTO COUPLE** key description in Chapter 3.)

## Note



To resolve two signals of equal amplitude with a frequency separation of 200 kHz, the resolution bandwidth must be less than the signal separation, and resolution of 100 kHz must be used. The next larger filter, 300 kHz, would exceed the 200 kHz separation and would not resolve the signals.

## Resolving Small Signals Hidden by Large Signals Using the Resolution Bandwidth Function

When dealing with resolution of signals that are not equal in amplitude, you must consider the shape of the IF filter as well as its 3 dB bandwidth. The shape of the filter is defined by the shape factor, which is the ratio of the 60 dB bandwidth to the 3 dB bandwidth. (Generally, the IF filters in this spectrum analyzer have shape factors of 15:1 or less.)

If a small signal is too close to a larger signal, the smaller signal can be hidden by the skirt of the larger signal. To view the smaller signal, you must select a resolution bandwidth such that  $k$  is less than  $a$ . See Figure 2-3.

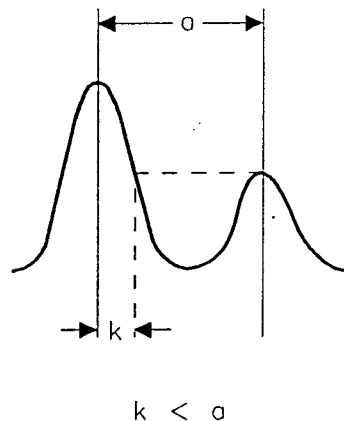

Figure 2-3. Resolution Bandwidth Requirements for Resolving Small Signals

The separation between the two signals must be greater than half the filter width of the larger signal at the amplitude level of the smaller signal.

**Example:** Resolve two input signals with a frequency separation of 200 kHz and an amplitude separation of 60 dB.

1. To obtain two signals with a 200 kHz separation, connect the equipment as shown in the previous section, "Resolving Signals of Equal Amplitude Using the Resolution Bandwidth Function."
2. Set the center frequency to 300 MHz and the span to 2 MHz: press **FREQUENCY** 300 **MHz**, then **SPAN** 2 **MHz**.

## 2-4 Analyzer Measurements and Applications

**Note**



When using an HP 8590B or HP 8592B and the signal peak cannot be found, increase the span to 20 MHz by pressing **SPAN 20 MHz**. The signal should be visible. Press **PEAK SEARCH**, **SIGNAL TRACK**, then **SPAN 2 MHz** to bring the signal to center screen. Press **SIGNAL TRACK** to turn the signal track function off.

3. Set the source to 300.2 MHz, so that the signal is 200 kHz higher than the calibration signal. Set the amplitude of the signal to -80 dBm (60 dB below the calibration signal).
4. Set the 300 MHz signal to the reference level by pressing **PEAK SEARCH**, **MKR ->**, then **MARKER -> REF LVL**.

If a 10 kHz filter with a typical shape factor of 15:1 is used, the filter will have a bandwidth of 150 kHz at the 60 dB point. The half-bandwidth (75 kHz) is narrower than the frequency separation, so the input signals will be resolved.

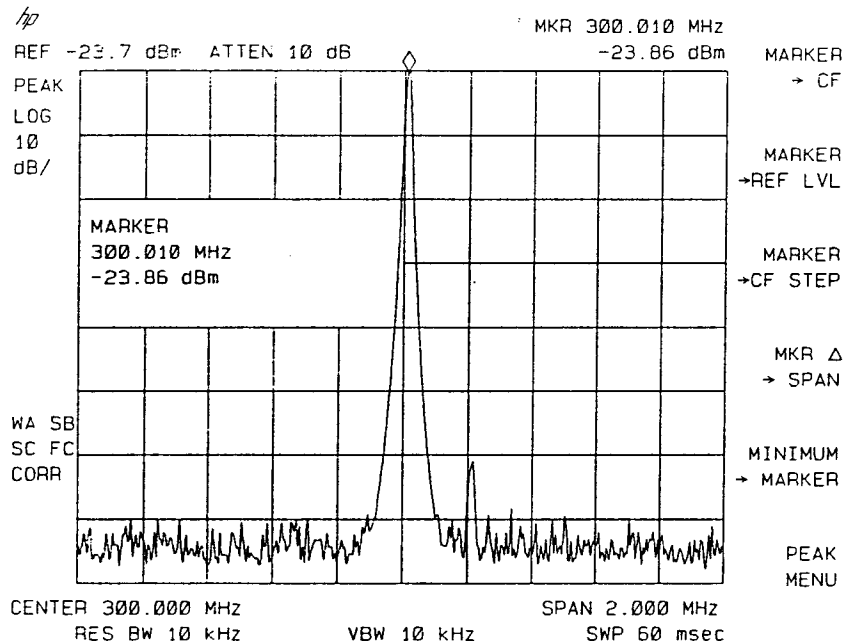

**Figure 2-4. Signal Resolution with a 10 kHz Resolution Bandwidth**

If a 30 kHz filter is used, the 60 dB bandwidth will be 450 kHz. Since the half-bandwidth (225 kHz) is wider than the frequency separation, the signals most likely will not be resolved. See Figure 2-5. (To determine resolution capability for intermediate values of amplitude level differences, consider the filter skirts between the 3 dB and 60 dB points to be approximately straight. In this case, we simply used the 60 dB value.)

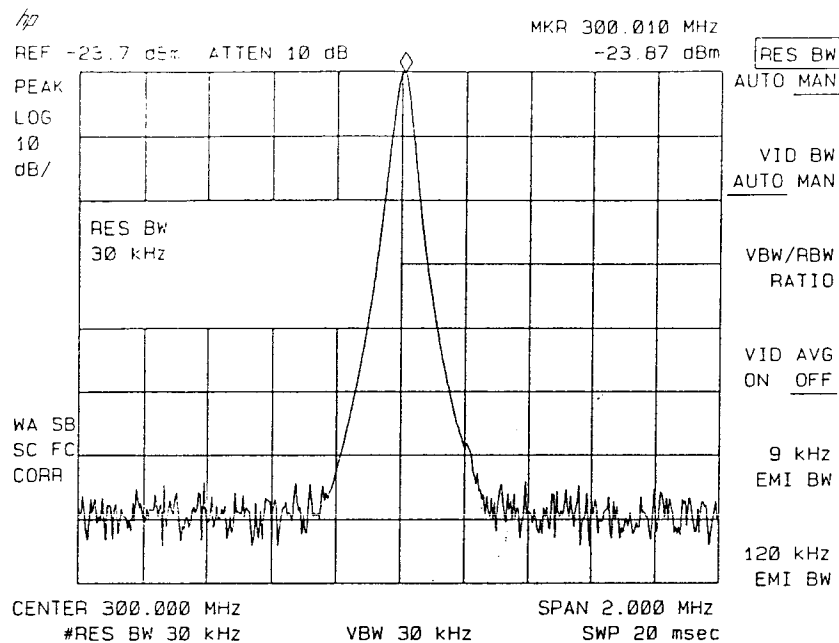

Figure 2-5. Signal Resolution with a 30 kHz Resolution Bandwidth

## Increasing the Frequency Readout Resolution Using the Marker Counter

**Note** This application should only be performed using an HP 8591A, HP 8593A, HP 8594A, or HP 8595A.



The marker counter increases the resolution and accuracy of frequency readout. When using the marker count function, if the bandwidth to span ratio is too small (less than 0.01), \*DECR SPAN appears in the upper-right corner of the screen.

**Example:** Increase the resolution and accuracy of the frequency readout on the signal of interest.

1. Place a marker on the signal of interest. (If you are using the CAL OUT signal, place the marker on the 300 MHz calibration signal. Press **FREQUENCY** 300 **MHz**, **SPAN** 100 **MHz**, and **PEAK SEARCH**.)
2. Press **MKR**, then **MKR CNT ON OFF** (ON should be underlined) to turn the marker counter on. COUNTER and the frequency and amplitude of the marker will appear in the active function area.
3. Increase the counter resolution by pressing **MORE 1 of 2**, **CNT RES AUTO MAN** and then entering the desired resolution using the step keys or the number/units keypad. For example, press 1 **kHz**. The marker counter readout is in the upper-right corner of the screen. The resolution can be set from 10 Hz to 100 kHz.

## 2-6 Analyzer Measurements and Applications

4. The marker counter remains on until turned off. Turn off the marker counter by pressing **MKR**, then either **MKR CNT ON OFF** (until OFF is underlined) or **MARKERS OFF**.

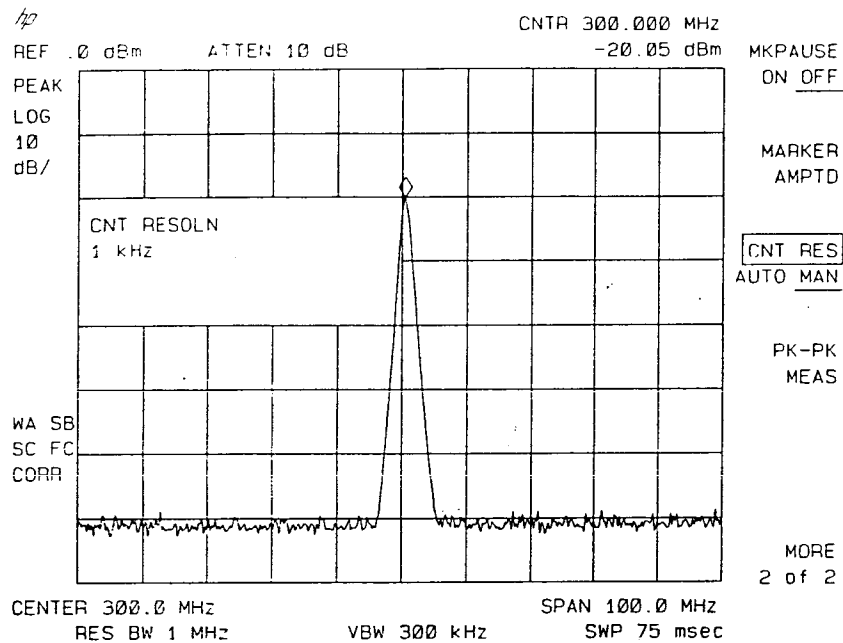

**Figure 2-6. Using the Marker Counter**



## Decreasing the Frequency Span Using the Signal Track Function

Using the spectrum analyzer's signal track function, you can quickly decrease the span while keeping the signal at center frequency.

**Example:** Examine a carrier signal in a 200 kHz span.

1. Press **PRESET**, tune to a carrier signal, and place a marker at the peak. (If you are using the CAL OUT signal, place the marker on the 300 MHz calibration signal. Press **FREQUENCY**, 300 **MHz**, **SPAN**, 200 **MHz**, and **PEAK SEARCH**.)
2. Press **SIGNAL TRACK** and the signal will move to the center of the screen, if it is not already positioned there (note that the marker must be on the signal). Because the signal track function automatically maintains the signal at the center of the screen, you can reduce the span quickly for a closer look. If the signal drifts off of the screen as you decrease the span, use a wider frequency span.
3. Press **SPAN**, 200 **kHz**. The span decreases in steps as automatic zoom is completed. You can also use the knob or step keys to decrease the span. See Figure 2-7.

Press **SIGNAL TRACK** again to turn off the tracking function.

**Note** When you are finished with the example, turn off the signal tracking function.

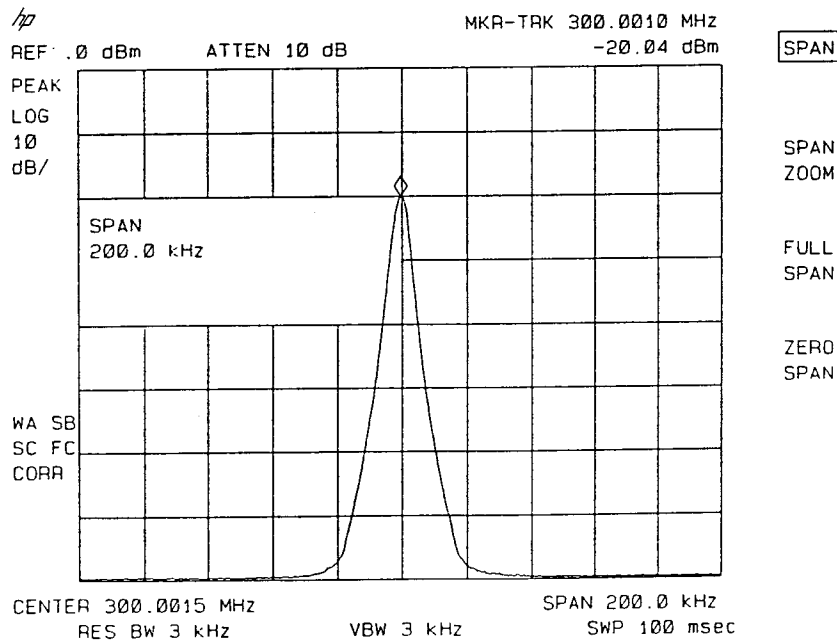

Figure 2-7. After Zooming In on the Signal

## 2-8 Analyzer Measurements and Applications

## Peaking Signal Amplitude with Preselector Peak

**Note**



This application should only be performed using an HP 8592B, HP 8593A, or HP 8595A.

PRESEL PEAK works in harmonic bands only (bands 1 through 4).

The preselector peak function automatically adjusts the preselector tracking to peak the signal at the active marker. Using preselector peak prior to measuring a signal yields the most accurate amplitude reading at the specified frequency. To maximize the peak response of the preselector and adjust the tracking, tune the marker to a signal and press **AMPLITUDE**, **PRESEL PEAK**.

**Note**



PRESEL PEAK maximizes the peak response of the signal of interest, but may degrade the frequency response at other frequencies. Use **PRESEL DEFAULT** or **PRESET** to clear previous preselector-peak values before measuring another frequency.

PRESEL DEFAULT provides best full single-band flatness for viewing several signals simultaneously.

**Example:** Use the knob, step keys, or **PEAK SEARCH** to place the marker on your signal and then press **PRESEL PEAK**. The message **CAL:PEAKING** appears in the active function block while the routine is working.

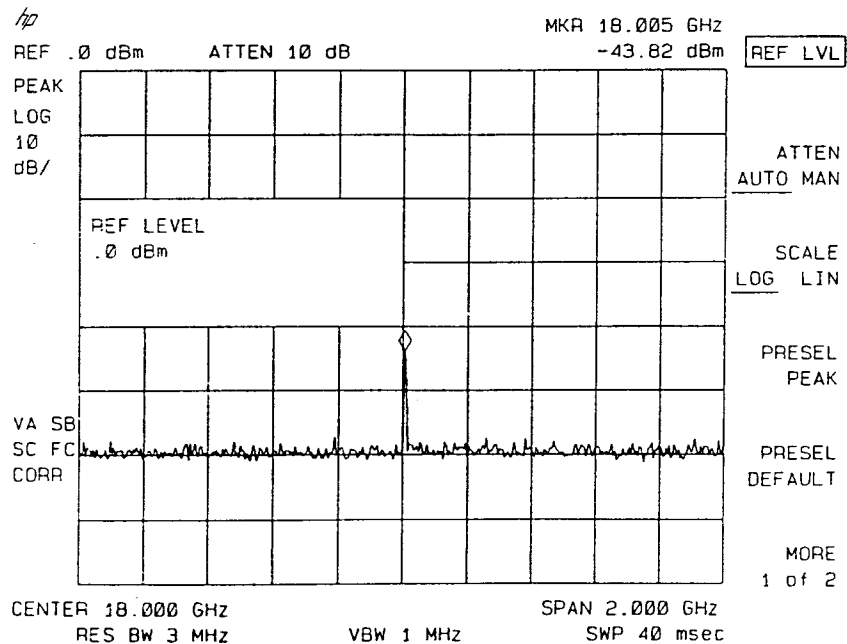

**Figure 2-8. Peaking Signal Amplitude Using Preselector Peak**

---

## Tracking Unstable Signals Using Signal Track and the Maximum Hold and Minimum Hold Functions

The signal track function is useful for tracking unstable signals that drift with time. The maximum hold and minimum hold functions are useful for displaying modulated signals which appear unstable, but have an envelope that contains the information-bearing portion of the signal.

**SIGNAL TRACK** may be used to track these unstable signals. Use **PEAK SEARCH** to place a marker on the highest signal on the display. Use **SIGNAL TRACK** to bring that signal to the center frequency of the graticule and adjust the center frequency every sweep to bring the selected signal point back to the center. **SPAN ZOOM** is a quick way to perform the **PEAK SEARCH**, **SIGNAL TRACK**, **SPAN** key sequence.

Note that the primary function of the signal track function is to track unstable signals, not to track a signal as the center frequency of the analyzer is changed. If you choose to use the signal track function when changing center frequency, check to ensure that the signal found by the tracking function is the correct signal.

**Example:** Use the signal track function to keep a drifting signal at the center of the display and monitor its change.

This example requires a modulated signal. An acceptable signal can be easily found by connecting an antenna to the spectrum analyzer input and tuning to the FM broadcast band (88 to 108 MHz). Set the spectrum analyzer center frequency for 100 MHz with a span of 20 MHz, an attenuator setting of 0 dB, and reference level setting of approximately -40 dBm. Your circumstances may be slightly different, depending on building shielding and proximity to transmitters.

1. Connect an antenna to the analyzer input.
2. Press **PRESET**, **FREQUENCY**, 100 **MHz**, **SPAN**, 20 **MHz**.

---

**Note** Use a different signal frequency if no signal is available at 100 MHz in your area.



3. Press **AMPLITUDE**, 40 **-dBm**, **ATTEN AUTO MAN**, 0 **+dBm**.
4. Press **SPAN**, **SPAN ZOOM**, 500 **kHz**.

Notice that the signal has been held in the center of the display.

---

**Note** If the signal you selected drifts too quickly for the analyzer to keep up with, use a wider span.



5. The signal frequency drift can be read from the screen if both the signal track and marker delta functions are active. Press **MARKER**, **MARKER DELTA**, **SIGNAL TRACK**; the marker readout indicates the change in frequency and amplitude as the signal drifts. (See Figure 2-9.)

### 2-10 Analyzer Measurements and Applications

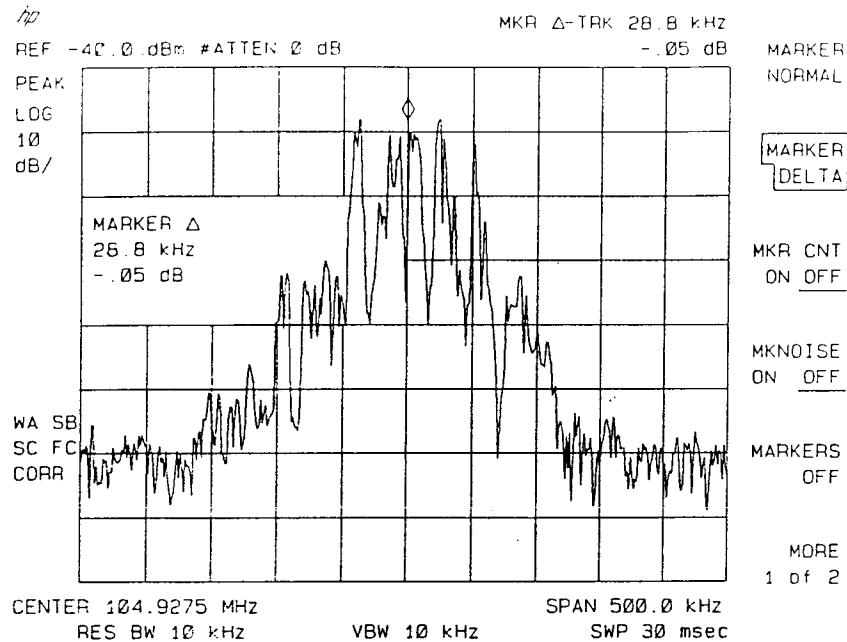

**Figure 2-9. Using Signal Tracking to Track an Unstable Signal**

The spectrum analyzer can measure the short- and long-term stability of a source. The maximum amplitude level and the frequency drift of an input signal trace can be displayed and held by using the maximum-hold function. The minimum amplitude level can be displayed by using minimum hold (available for trace C only).

You can use the maximum-hold and minimum-hold functions if, for example, you want to determine how much of the frequency spectrum an FM signal occupies.

**Example:** Using the maximum-hold and minimum hold functions, monitor the envelopes of a signal.

1. Connect an antenna to the spectrum analyzer input.
2. Press **PRESET**, **FREQUENCY**, 100 **MHz**, and **SPAN**, 20 **MHz**.
3. Press **AMPLITUDE**, 40 **-dBm**, **ATTEN AUTO MAN**, 0 **+dBm**, **SPAN**, **SPAN ZOOM**, 500 **kHz**.

Notice that the signal has been held in the center of the display.

4. Turn off the signal track function by pressing **SIGNAL TRACK**.
5. To measure the excursion of the signal, press **TRACE**, **MAX HOLD A**. As the signal varies, maximum hold maintains the maximum responses of the input signal, as shown in Figure 2-10.

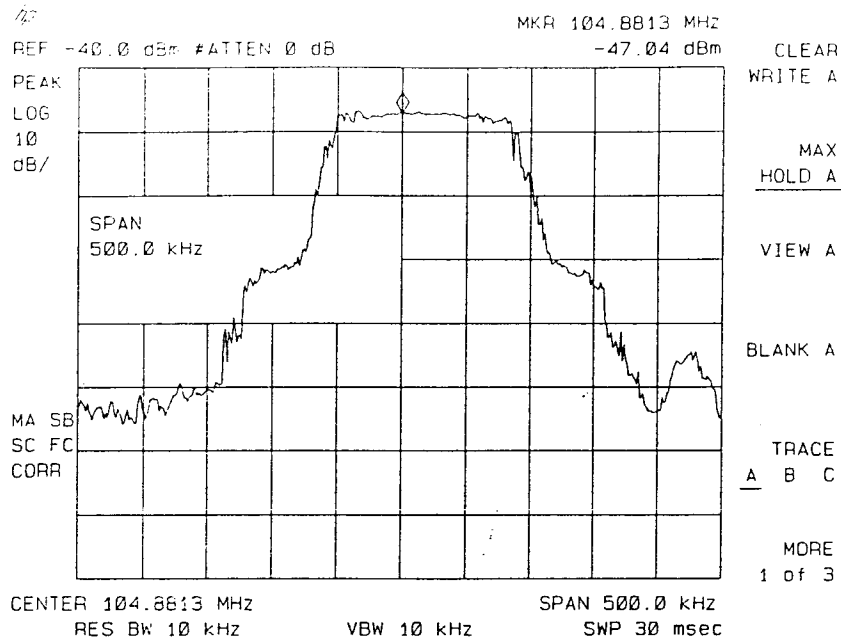

**Figure 2-10. Viewing an Unstable Signal Using Max Hold A**

Annotation on the left side of the screen indicates the trace mode. For example, MA SB SC indicates trace A is in maximum-hold mode, trace B and trace C are in store-blank mode. (See "Screen Annotation" in Chapter 1.)

6. Press **TRACE**, **TRACE A B C** to select trace B. (Trace B is selected when B is underlined.) Press **CLEAR WRITE B** to place trace B in clear-write mode, which displays the current measurement results as it sweeps. Trace A remains in maximum-hold mode, showing the frequency shift of the signal.
7. Press **TRACE A B C** to select trace C (C should be underlined). Press **MIN HOLD C**. Trace C is in the minimum-hold mode and displays the minimum amplitude of the frequency drift of the signal.

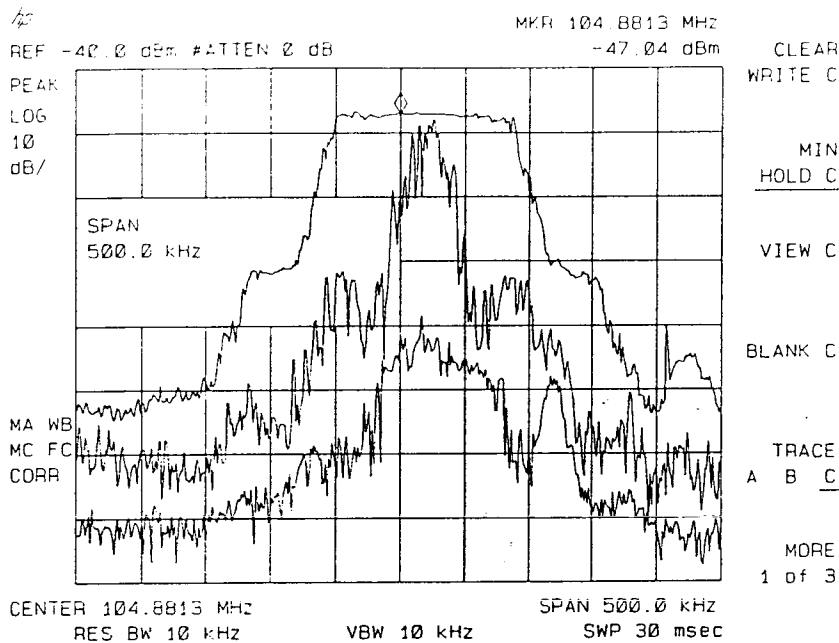

Figure 2-11. Viewing an Unstable Signal With Max Hold, Clear Write, and Min Hold

## Comparing Signals Using Delta Markers

Using the spectrum analyzer, you can easily compare frequency and amplitude differences between signals, such as radio or television signal spectra. The spectrum analyzer's delta marker function lets you compare two signals when both appear on the screen at one time or when only one appears on the screen.

**Example:** Measure the differences between two signals on the same display screen.

1. Connect the analyzer's CAL OUT to the INPUT 50Ω. Press **PRESET**. For the HP 8593A only, set the center frequency to 900 MHz and the span to 1.8 GHz: press **FREQUENCY**, 900 **MHz**, **SPAN**, 1.8 **GHz**.

The calibration signal and its harmonics appear on the display.

2. Press **PEAK SEARCH** to place a marker at the highest peak on the display. The **NEXT PK RIGHT** and **NEXT PK LEFT** softkeys move the marker from peak to peak. Press **NEXT PK RIGHT** to move the marker to the 300 MHz calibration signal. See Figure 2-12.

The signal that appears at the left edge of the screen is the spectrum analyzer's local oscillator (LO) and represents 0 Hz.

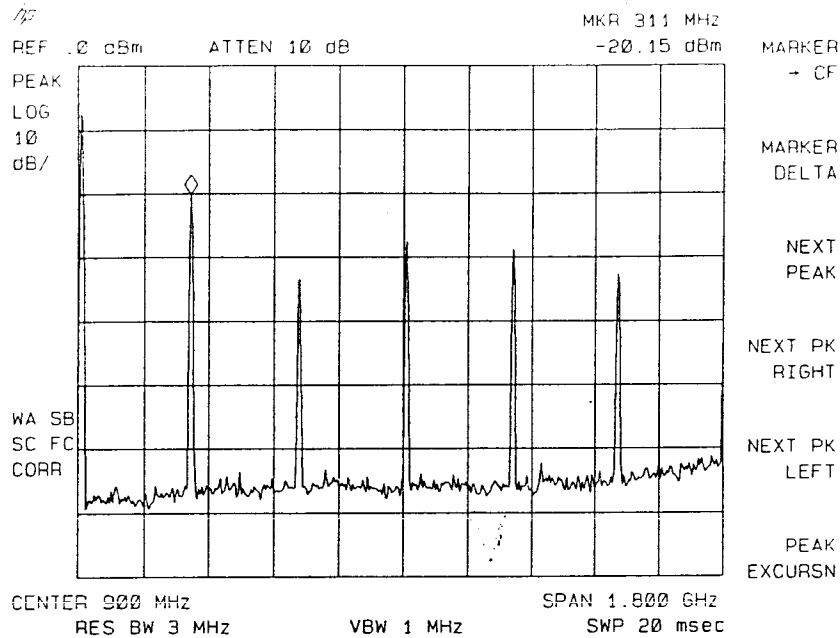

Figure 2-12. Placing a Marker on the CAL OUT Signal

3. Press **MARKER DELTA** to activate a second marker at the position of the first marker. Move the second marker to another signal peak using the **NEXT PK RIGHT** or **NEXT PK LEFT** softkeys or the knob.
  4. The amplitude and frequency difference between the markers is displayed in the active function block and in the upper-right corner of the screen. See Figure 2-13.
- Press **(MKR)**, **MARKERS OFF** to turn the markers off.

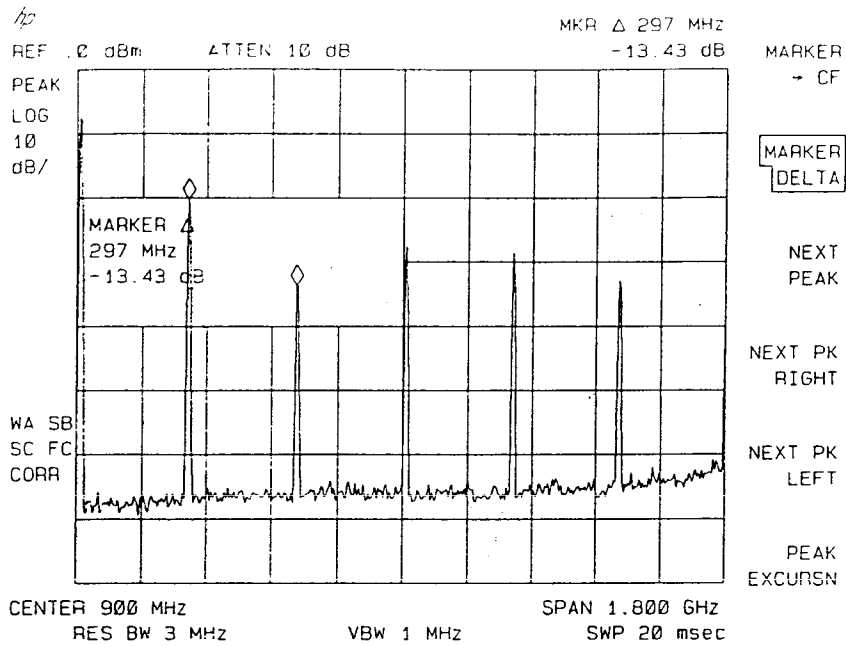

Figure 2-13. Using the Marker Delta Function

- The **DELTA MEAS** softkey also finds and displays the frequency and amplitude difference between the two highest-amplitude signals. To use this automatic function, first remove the local oscillator (LO) signal from the display by pressing **FREQUENCY**, **START FREQ**, and turning the knob until the LO signal at 0 Hz is off the screen. Press **MEAS/USER**, **MORE 1 of 2**, **DELTA MEAS**. See Figure 2-14.

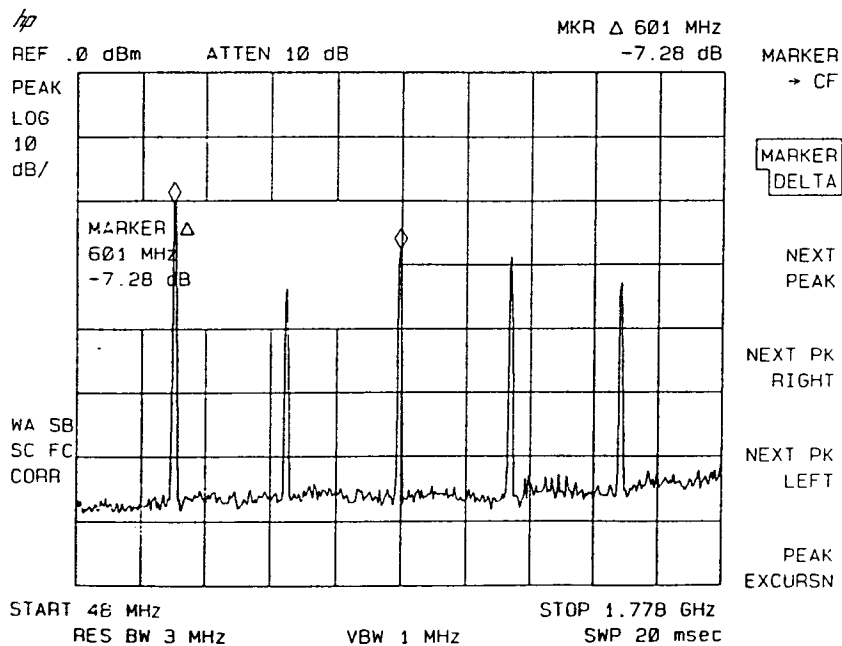

Figure 2-14. Using the Delta Meas Function



The frequency and amplitude differences between the signals appear in the active function block. In addition, the softkeys accessed by **PEAK SEARCH** appear on the screen.

**Example:** Measure the frequency and amplitude difference between two signals that do not appear on the screen at one time. (This technique is useful for harmonic distortion tests when narrow span and narrow bandwidth are necessary to measure the low-level harmonics.)

1. Connect the analyzer's CAL OUT to the INPUT 50Ω (if you have not already done so). Press **PRESET**, **FREQUENCY**, 300 **MHz**, **SPAN** and the step down key (**▼**) to narrow the frequency span until only one signal appears on the screen.
2. Press **PEAK SEARCH** to place a marker on the peak.
3. Press **MARKER DELTA** to identify the position of the first marker.
4. Press **FREQUENCY** to activate center frequency. Turn the knob clockwise slowly to adjust the center frequency until a second signal peak is placed at the position of the second marker. It may be necessary to pause occasionally while turning the knob to allow a sweep to update the trace. The first marker remains on the screen at the amplitude of the first signal peak.

**Note** Changing the reference level changes the marker delta amplitude readout.



The annotation in the upper-right corner of the screen indicates the amplitude and frequency difference between the two signals. See Figure 2-15.

To turn the markers off, press **MKR** and **MARKERS OFF**.

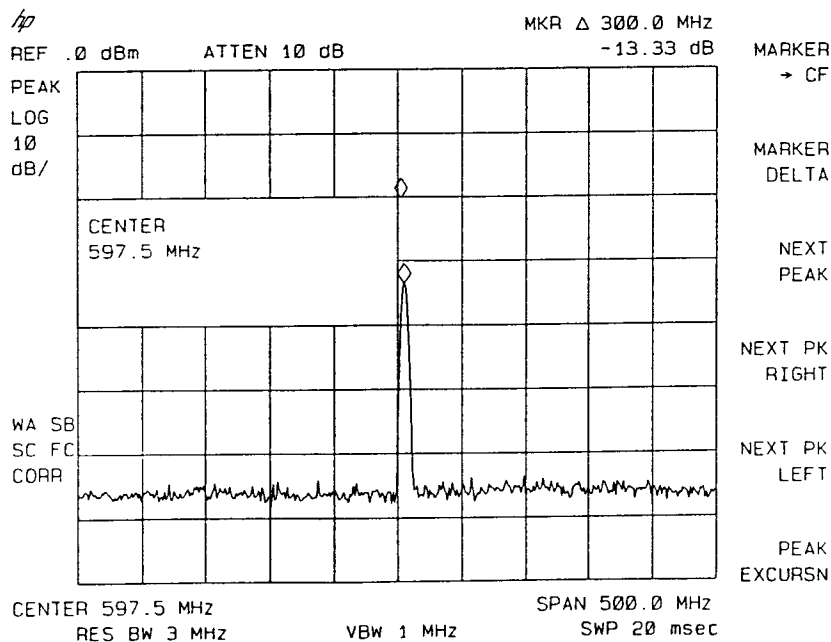

**Figure 2-15. Frequency and Amplitude Difference Between Signals**

## 2-16 Analyzer Measurements and Applications

---

## Measuring Low-Level Signals Using Attenuation, Video Bandwidth, and Video Averaging

Spectrum analyzer sensitivity is the ability to measure low-level signals and is limited by the noise generated inside the spectrum analyzer. The spectrum analyzer input attenuator and bandwidth settings affect the sensitivity by changing the signal-to-noise ratio. The attenuator affects the level of a signal passing through the instrument, whereas the bandwidth affects the level of internal noise without affecting the signal. In the first two examples in this section, the attenuator and bandwidth settings are adjusted to view low-level signals.

If, after adjusting the attenuation and resolution bandwidth, a signal is still near the noise, visibility can be improved by using the video-bandwidth and video-averaging functions, as demonstrated in the third and fourth examples.

**Example:** If a signal is very close to the noise floor, reducing input attenuation brings the signal out of the noise. Reducing the attenuation to 0 dB maximizes signal power in the analyzer.

---

### Note

The total power of all input signals at the analyzer must not exceed the maximum power level for the analyzer.



1. Connect an antenna to the spectrum analyzer input. Press **PRESET**.
2. Reduce the frequency range to view a low-level signal of interest. For example, narrow the frequency span from 88 MHz to 108 MHz by pressing **FREQUENCY**, **START FREQ**, 88 **MHz**, **STOP FREQ**, 108 **MHz**.
3. Place a marker on the low-level signal of interest. Press **MKR** and use the knob to position the marker at the signal's peak.
4. Place the signal at center frequency by pressing **MKR ->**, **MARKER -> CF**.
5. Reduce the span to 10 MHz. Press **SPAN**, and then use the step-down key (**▼**). See Figure 2-16.

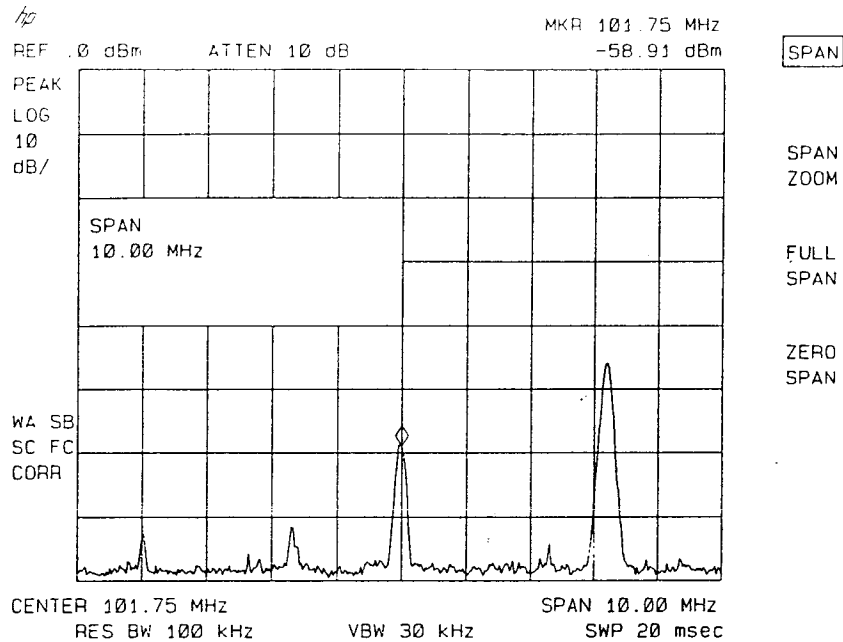

Figure 2-16. Low-Level Signal

6. Press **AMPLITUDE**, **ATTEN AUTO MAN**. Press the step-up key (**▲**) once to select 20 dB attenuation. Increasing the attenuation moves the noise floor closer to the signal.

A “#” mark appears next to the ATTEN annotation at the top of the display, indicating the attenuation is no longer coupled.

7. To see the signal more clearly, press 0 **dBm**. Zero attenuation makes the signal more visible. (As a precaution to protect the spectrum analyzer’s input mixer, 0 dB RF attenuation can be selected only with the number/units keypad.)

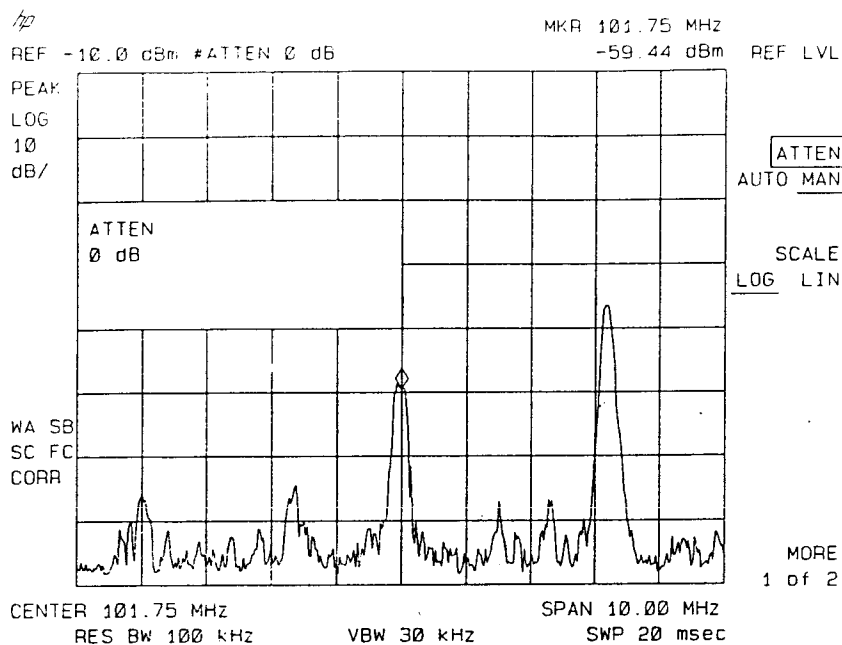
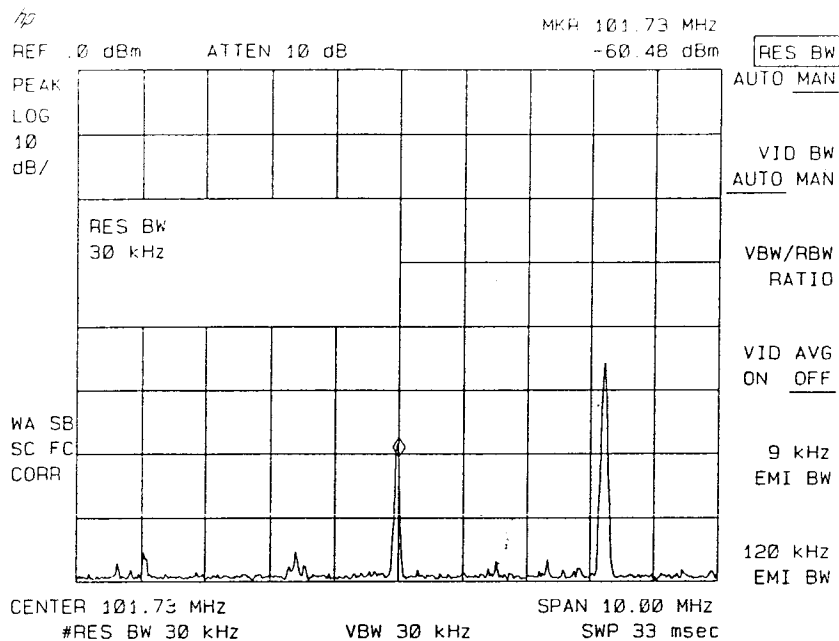

Figure 2-17. Using 0 dB Attenuation

Before connecting other signals to the analyzer input, increase the RF attenuation to protect the analyzer's input mixer: press **ATTEN AUTO MAN** so that **AUTO** is underlined or press **AUTO COUPLE**, **AUTO ALL**.

**Example:** The resolution bandwidth can be decreased to view low-level signals.

1. As in the previous example, connect an antenna to the analyzer input. Set the analyzer to view a low-level signal.
2. Press **BW**, **▼**. The low-level signal appears more clearly because the noise level is reduced. See Figure 2-18.



**Figure 2-18. Decreasing Resolution Bandwidth**

A “#” mark appears next to the RES BW annotation at the lower-left corner of the screen, indicating that the resolution bandwidth is uncoupled.

As the resolution bandwidth is reduced, the sweep time is increased to maintain calibrated data.

**Example:** The video-filter control is useful for noise measurements and observation of low-level signals close to the noise floor. The video filter is a post-detection low-pass filter that smooths the displayed trace. When signal responses near the noise level of the analyzer are visually masked by the noise, the video filter can be narrowed to smooth this noise and improve the visibility of the signal. (Reducing video bandwidths requires slower sweep times to keep the analyzer calibrated.)

Using the video bandwidth function, measure the amplitude of a low-level signal.

1. As in the first example, connect an antenna to the analyzer input. Set the analyzer to view a low-level signal.
2. Narrow the video bandwidth by pressing **[BW]**, **VID BW AUTO MAN**, and the step-down key (**[▼]**). This clarifies the signal by smoothing the noise, which allows better measurement of the signal amplitude.

A “#” mark appears next to the VBW annotation at the bottom of the screen, indicating that the video bandwidth is not coupled to the resolution bandwidth.

Instrument preset conditions couple the video bandwidth to the resolution bandwidth so that the video bandwidth is equal to or narrower than the resolution bandwidth. If the bandwidths are uncoupled when video bandwidth is the active function, pressing **VID BW AUTO MAN** (so that AUTO is underlined) recouples the bandwidths. See Figure 2-19.

## 2-20 Analyzer Measurements and Applications

**Note**



The video bandwidth must be set wider than the resolution bandwidth when measuring impulse noise levels.

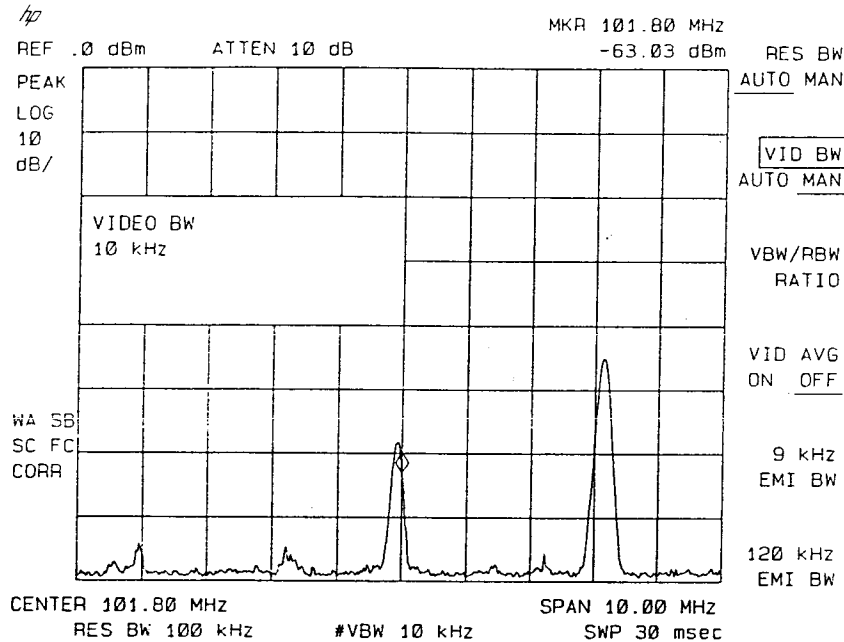

**Figure 2-19. Decreasing Video Bandwidth**

**Example:** If a signal level is very close to the noise floor, video averaging is another way to make the signal more visible.

**Note**



The time required to construct a full trace that is averaged to the desired degree is approximately the same when using either the video-bandwidth or the video-averaging technique. The video bandwidth technique completes the averaging as a slow sweep is taken, whereas the video averaging technique takes many sweeps to complete the average. Characteristics of the signal being measured such as drift and duty cycle determine which technique is appropriate.

Video averaging is a digital process in which each trace point is averaged with the previous trace-point average. Selecting video averaging changes the detection mode from peak to sample. The result is a sudden drop in the displayed noise level. The sample mode displays the instantaneous value of the signal at the end of the time or frequency interval represented by each display point, rather than the value of the peak during the interval. Sample mode is not used to measure signal amplitudes accurately because it may not find the true peak of the signal.

Video averaging clarifies low-level signals in wide bandwidths by averaging the signal and the noise. As the analyzer takes sweeps, you can watch video averaging smooth the trace.

1. Position a low-level signal on the spectrum analyzer screen.

2. Press **TRACE**. MORE 1 of 3, VID AVG ON OFF. When ON is underlined, the video-averaging routine is initiated. As the averaging routine smooths the trace, low-level signals become more visible. VID AVG 100 appears in the active function block.

The number represents the number of samples (or sweeps) taken to complete the averaging routine.

3. To set the number of samples, use the number/units keypad. For example, press **VID AVG ON OFF** (so that ON is underlined), 25 (Hz). Turn video averaging off and on again by pressing **VID AVG ON OFF (OFF)**, **VID AVG ON OFF (ON)**.

The number of samples equals the number of sweeps in the averaging routine.

During averaging, the current sample appears at the left side of the graticule. Changes in active functions settings, such as the center frequency or reference level, will also restart the sampling. The sampling will also restart if video averaging is turned off and then on again.

Once the set number of sweeps has been completed, the analyzer continues to provide a running average based on this set number.

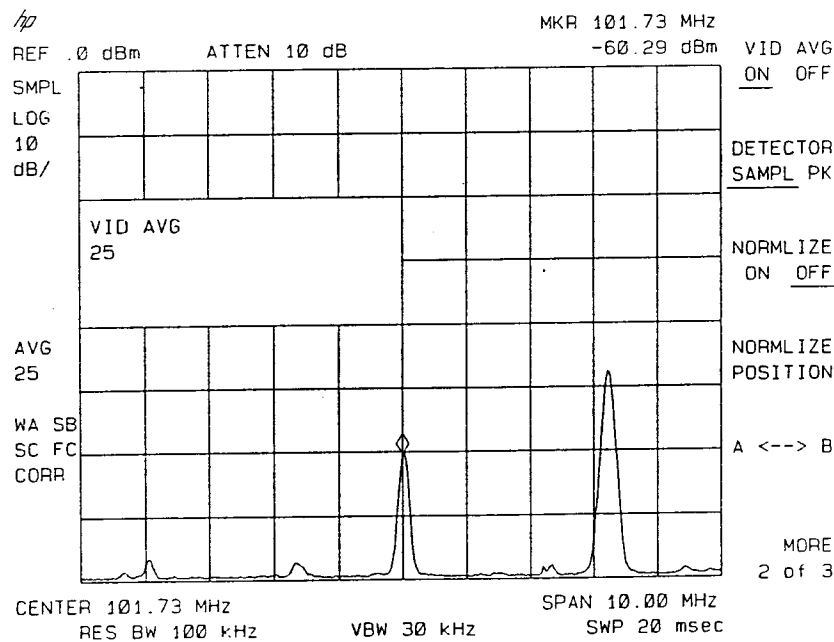

**Figure 2-20. Using the Video Averaging Function**

## Identifying Distortion Products Using the RF Attenuator and Traces

### Distortion from the Analyzer

High-level input signals may cause spectrum analyzer distortion products that could mask the real distortion measured on the input signal. Using trace B and the RF attenuator, you can determine which signals, if any, are internally generated distortion products.

**Example:** Using a signal from a signal generator, determine whether the harmonic distortion products are generated by the spectrum analyzer.

1. Connect a signal generator to the analyzer's INPUT 50Ω. Set the signal generator frequency to 200 MHz and the amplitude to 0 dBm.

Set the center frequency of the spectrum analyzer to 400 MHz and the span to 500 MHz: press **FREQUENCY**, 400 **MHz**, **SPAN** 500 **MHz**. The signal shown in Figure 2-21 produces harmonic distortion products in the spectrum analyzer's input mixer.

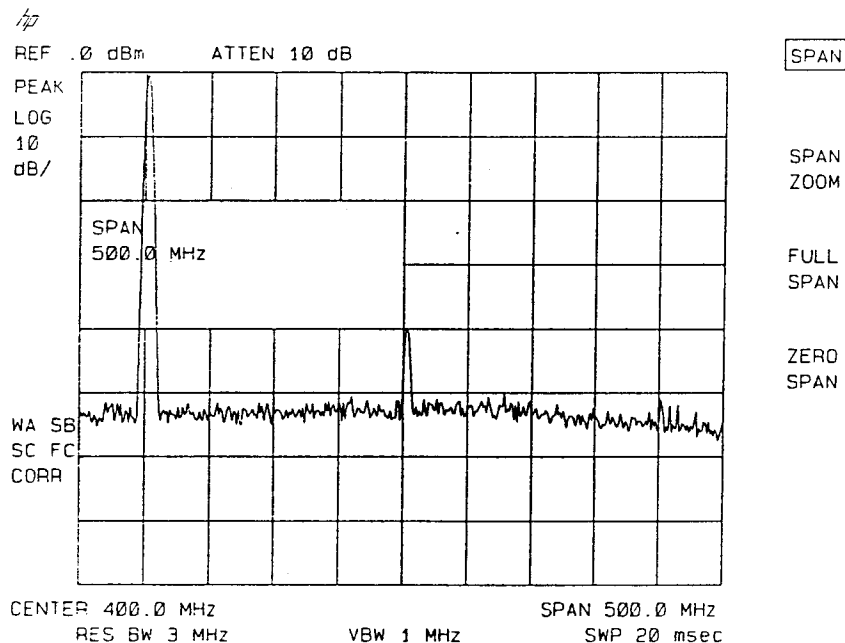

Figure 2-21. Harmonic Distortion

2. Change the span to 200 MHz: press **SPAN**, 200 **MHz**.
3. Change the attenuation to 0 dB: press **AMPLITUDE**, **ATTEN AUTO MAN**, 0 **dBm**.
4. To determine whether the harmonic distortion products are generated by the spectrum analyzer, first save the screen data in trace B.

Press **TRACE**, TRACE A B C (until trace B is underlined), then **CLEAR WRITE B**. Allow the trace to update (two sweeps) and press **VIEW B**, **PEAK SEARCH**, **MARKER DELTA**. The analyzer display shows the stored data in trace B and the measured data in trace A.

5. Next, increase the RF attenuation by 10 dB: press **AMPLITUDE**, **ATTEN AUTO MAN**, and the step-up key (**▲**) once. (See Figure 2-22.)



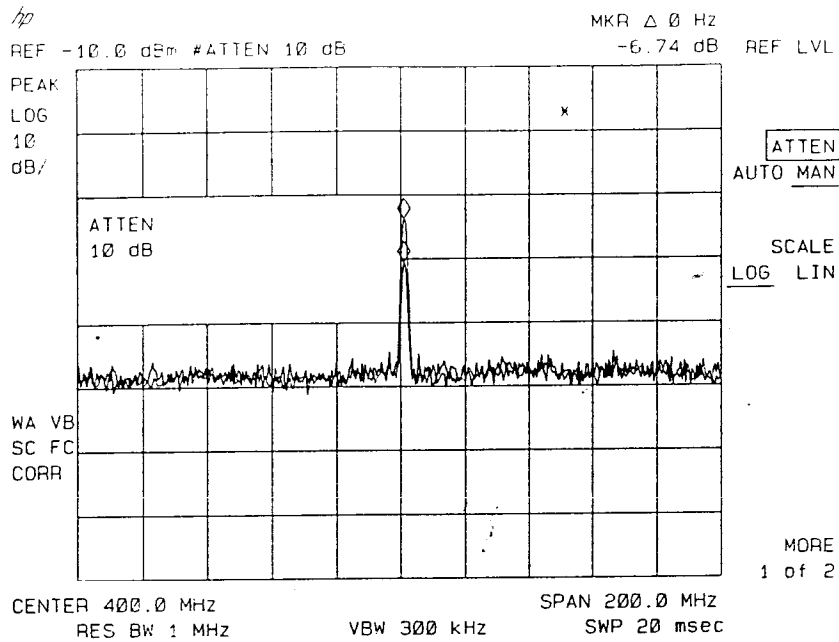

Figure 2-22. RF Attenuation of 10 dB

- Compare the response in trace A to the response in trace B. If the distortion product decreases as the attenuation increases, distortion products are caused by the analyzer's input mixer.

The change in the distortion product is shown by the marker-delta value. The high-level signals causing the overload conditions must be attenuated to eliminate the interference caused by the internal distortion.

If the responses in trace A and trace B differ, as in Figure 2-22, then attenuation is required. If the distortion is not caused internally, there is no change in the signal level. For example, the signal amplitude in Figure 2-23 is not high enough to cause internal distortion in the analyzer.

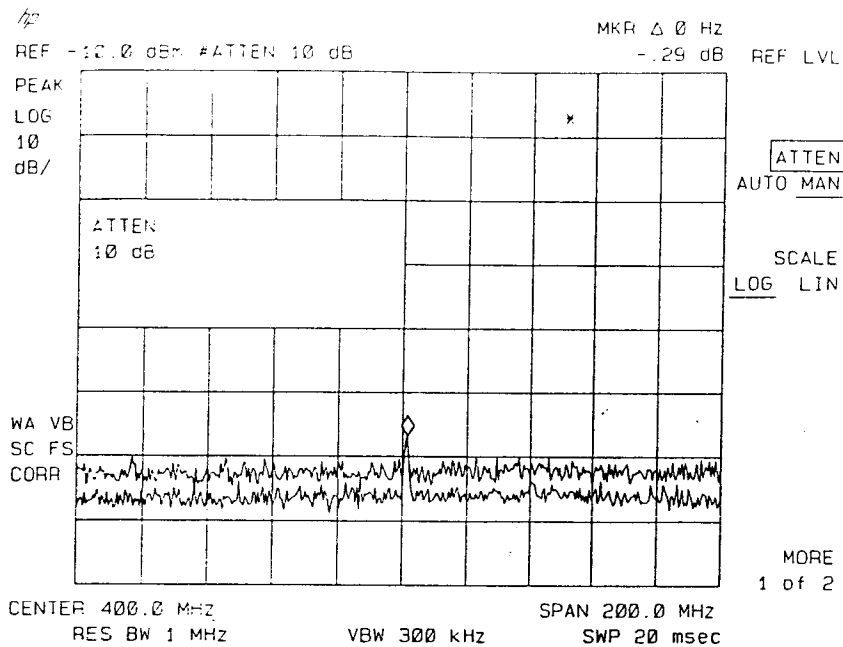

Figure 2-23. No Harmonic Distortion

### Third-Order Intermodulation Distortion

Two-tone, third-order intermodulation distortion is a common problem in communication systems. When two signals are present in a system, they can mix with the second harmonics generated and create third-order intermodulation distortion products, which are located close to the original signals. These distortion products are generated by system components such as amplifiers and mixers.

**Example:** Test a device for third-order intermodulation. This example uses two sources, one set to 300 MHz and the other to approximately 301 MHz. (Other source frequencies may be substituted, but try to maintain a frequency separation of approximately 1 MHz.)

1. Connect the equipment as shown in Figure 2-24.

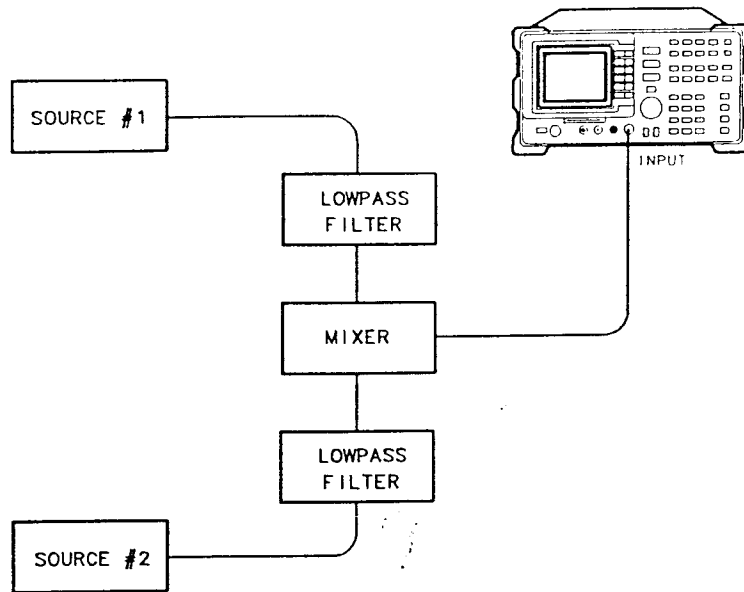

Figure 2-24. Third-Order Intermodulation Equipment Setup

2. Set one source to 300 MHz and the other source to 301 MHz for a frequency separation of 1 MHz. Set the sources equal in amplitude (in this example, the sources are set to  $-5$  dBm).
3. Tune both signals onto the screen by setting the center frequency between 300 and 301 MHz. Then, using the knob, center the two signals on the display. Reduce the frequency span to 5 MHz for a span wide enough to include the distortion products on the screen. To be sure the distortion products are resolved, reduce the resolution bandwidth until the distortion products are visible. Press **(BW)**, **RES BW**, and then use the step-down key (**(▼)**) to reduce the resolution bandwidth until the distortion products are visible.
4. For best dynamic range, set the mixer input level to  $-40$  dBm and move the signal to the reference level: press **(AMPLITUDE)**, **MORE 1 of 2**, **MAX MXR LEVEL**, 40 **(-dBm)**.

The analyzer automatically sets the attenuation so that a signal at the reference level will be a maximum of  $-40$  dBm at the input mixer.

5. To measure a distortion product, press **(PEAK SEARCH)** to place a marker on a source signal. To activate the second marker, press **MARKER DELTA**. Using the knob, adjust the second marker to the peak of the distortion product that is beside the test tone. The difference between the markers is displayed in the active function block.

To measure the other distortion product, press **(PEAK SEARCH)**, **NEXT PEAK**. This places a marker on the next highest peak, which, in this case, is the other source signal.

To measure the difference between this test tone and the second distortion product, press **MARKER DELTA** and use the knob to adjust the second marker to the peak of the second distortion product. (See Figure 2-25.)

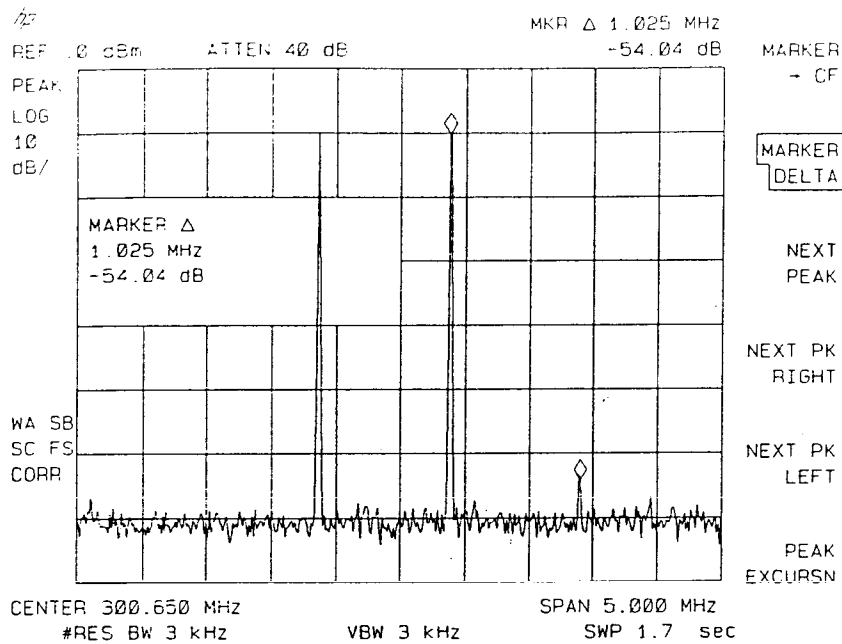

Figure 2-25. Measuring the Distortion Product

## Using the Analyzer As a Receiver in Zero Frequency Span

The spectrum analyzer operates as a fixed-tuned receiver in zero span. The zero span mode can be used to recover modulation on a carrier signal.

Center frequency in the swept-tuned mode becomes the tuned frequency in zero span. The horizontal axis of the screen becomes calibrated in time, rather than frequency. Markers display amplitude and time values.

The following functions establish a clear display of the video waveform:

- Trigger stabilizes the waveform trace on the display by triggering on the modulation envelope. If the signal's modulation is stable, video trigger synchronizes the sweep with the demodulated waveform.
- Linear mode should be used in amplitude modulation (AM) measurements to avoid distortion caused by the logarithmic amplifier when demodulating signals.
- Sweep time adjusts the full sweep time from 20 ms (20  $\mu$ s in zero span with Option 101), to 100 s. The sweep time readout refers to the full 10-division graticule. Divide this value by 10 to determine sweep time per division.
- Resolution and video bandwidth are selected according to the signal bandwidth.

Each of the coupled function values remains at its current value when zero span is activated. Video bandwidth is coupled to resolution bandwidth. Sweep time is not coupled to any other function.

**Example:** View the modulation waveform of an AM signal in the time domain.

1. To obtain an AM signal, you can either connect an antenna to the analyzer input and tune to a commercial AM broadcast station or you can connect a source to the analyzer input and set the percent modulation of the source. (If a headset is used with the VIDEO OUT connector, the spectrum analyzer will operate as a radio.)
2. First, center and zoom in on the signal in the frequency domain. (See "Decreasing the Frequency Span Using the Signal Track Function.") Be sure to turn off the signal track function, since the signal track function must be off for zero span. See Figure 2-26.

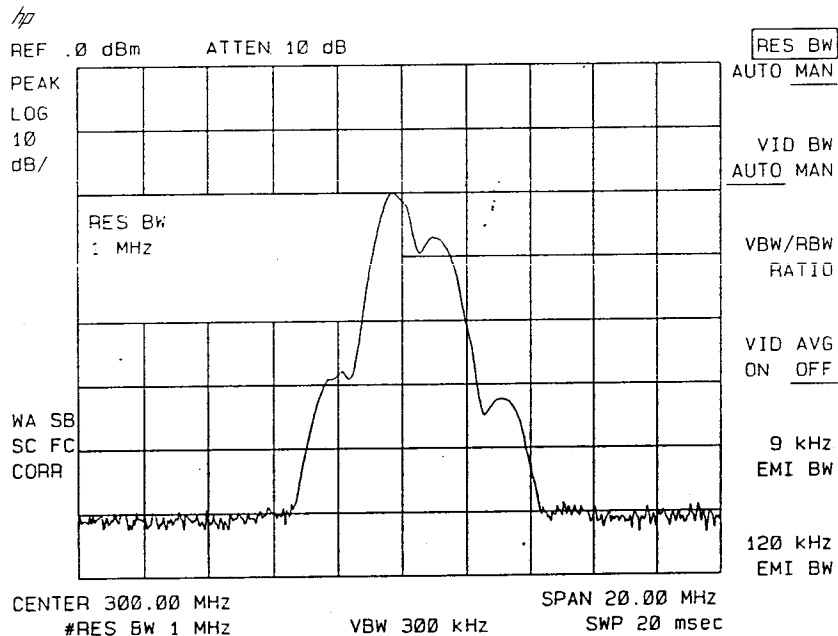

**Figure 2-26. Viewing an AM Signal**

3. To demodulate the AM, press **[BW]**. Increase the resolution bandwidth to include both sidebands of the signal within the passband of the spectrum analyzer.
4. Next, position the signal peak near the reference level and select a linear voltage display. Press **[AMPLITUDE]** and change the reference level, then press **SCALE LOG LIN** to underline LIN.
5. To select zero span, either press **[SPAN]**, **0 [Hz]** or press **ZERO SPAN**. See Figure 2-27. If the modulation is a steady tone (for example, from a signal generator), use video trigger to trigger on the waveform and stabilize the display. Adjust the sweep time to change the horizontal scale.

Use markers and delta to measure time parameters of the waveform.

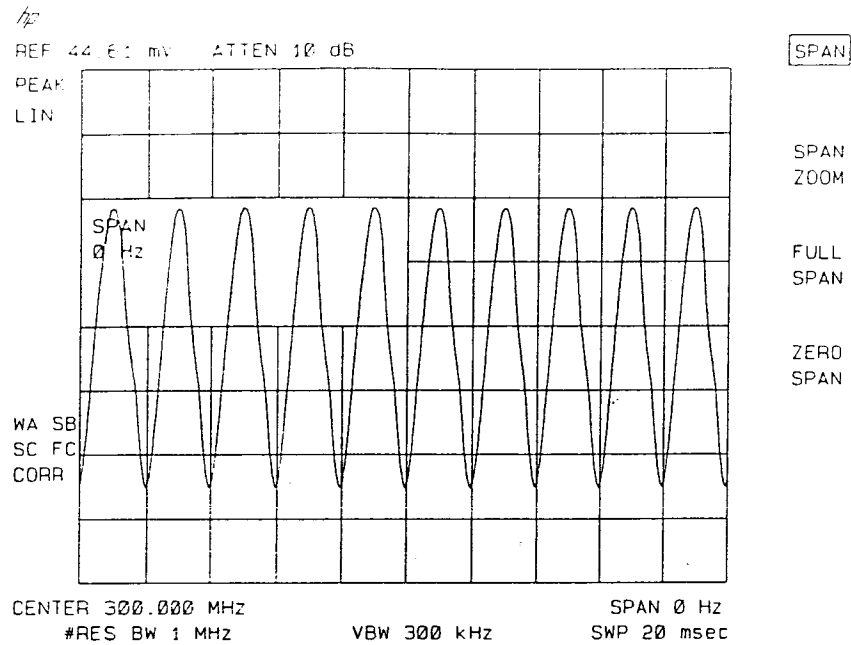

Figure 2-27. Measuring Modulation In Zero Span

## Measuring Amplitude Modulation with the Fast Fourier Transform Function

The fast Fourier transform (FFT) function of the spectrum analyzer allows measurements of amplitude modulation (AM). FFT transforms demodulated AM data from the time domain (zero span) to the frequency domain. The FFT function calculates the magnitude of each frequency component from a block of time-domain samples of the input signal. The FFT function is commonly used to measure AM at rates that cannot be measured in the normal frequency domain. The FFT is a post-detection fast Fourier transform function and cannot be used to resolve continuous wave or carrier signals.

The FFT function requires a specific analyzer setup. First, an AM signal is demodulated in the time domain. In order to do this, the resolution bandwidth is widened to include the signal sidebands within the passband of the spectrum analyzer. Next, zero span is selected so that the spectrum analyzer operates as a fixed-tuned receiver. Tuning is centered about the AM carrier.

When **MEAS/USER**, **FFT MEAS** is pressed, the function sets sample-detection mode and takes a sweep to obtain a sample of the input signal. Then the spectrum analyzer executes a series of computations on the time data to produce the frequency-domain results.

### Note



After the FFT function is used, the markers are still in FFT mode for use in evaluating data. Turn off the markers before attempting to use them in the normal fashion.

**Example:** Measure the sidebands on a signal, using the fast Fourier transform function.

1. Connect a signal generator to the analyzer's INPUT 50 $\Omega$ . Adjust the signal generator to produce an AM signal. (For example, set the modulation rate to 60 Hz.)
2. Center the signal on the frequency scale of the analyzer screen. For the HP 8593A, decrease the span to 200 kHz.
3. Press **BW** 3 **(kHz)**. The resolution bandwidth should be about 10 times greater than the highest modulation frequency of interest. (In this case, the fourth harmonic of 60 Hz is 240 Hz.)
4. Press **VID BW AUTO MAN**, 1 **(kHz)**. The video bandwidth should be about two times greater than the highest modulation frequency of interest. If the video bandwidth is too large, "alias" signals may appear in the FFT when signals above the highest modulation frequency of interest are present.
5. Change the amplitude scale to linear by pressing **AMPLITUDE**, then **SCALE LOG LIN** so that **LIN** is underlined.
6. Press **REF LVL** and turn the knob to change the reference level, placing the signal peak within the top two divisions of the screen. The signal must be below the reference level. Press **SPAN**, 0 **(Hz)**. The spectrum analyzer now operates as a fixed-tuned receiver.
7. See Figure 2-28, which shows maximum modulation frequency ( $f_m$ ) in Hz versus sweep time ( $T_s$ ) in seconds. Set the sweep time less than  $T_s(\text{max})$  for that maximum modulation frequency ( $f_m$ ) including the harmonics of the signal. The upper curve relates the sweep time to the maximum modulation frequency that can be observed (that is, the modulation frequency represented by the right edge of the graticule). The lower curve represents the modulation frequency one division from the left side of the graticule.

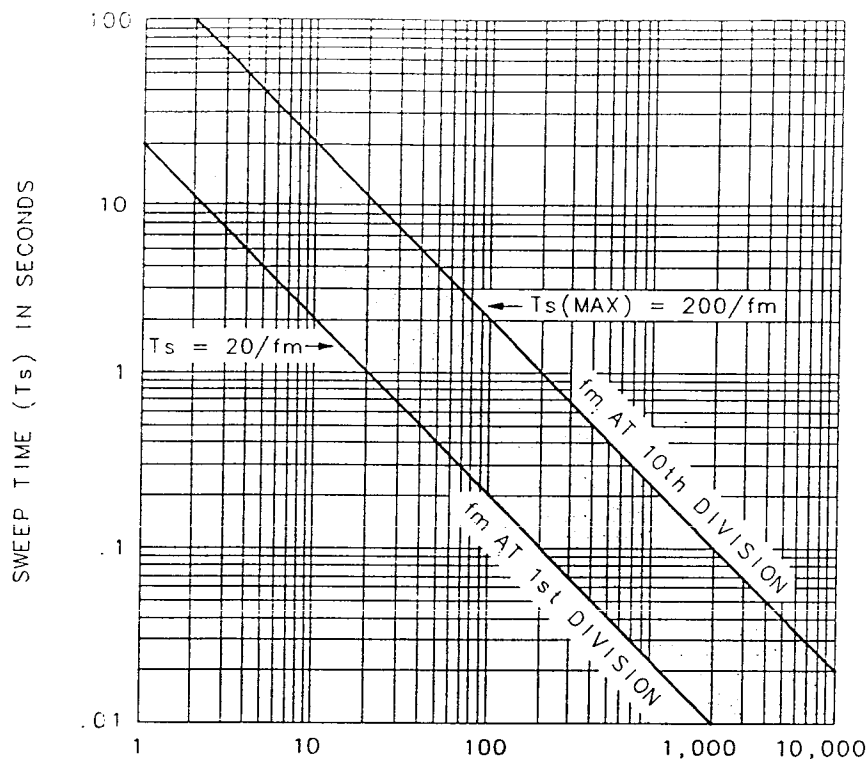

MAX MODULATING FREQUENCY ( $f_m$ ) IN Hz (INCLUDING HARMONICS)

**Figure 2-28. Maximum Modulation Frequency versus Sweep Time**

Set the sweep time to fall in the shaded area between the two lines and closer to the lower line to avoid the effects of aliasing. Note that the upper line (marked “ $f_m$  AT 10th DIVISION”) represents sampling at exactly the Nyquist rate, and some aliasing may be seen when a value for sweep time is close to the upper line. (Frequencies greater than the maximum modulation frequency for a specific sweep time will not be displayed accurately.) Press **[SWEEP]** to set the sweep time according to the figure. (For a right edge graticule limit of 250 Hz, use 800 ms.)

8. Press **[SAVE]**, INTRNL CRD (INTRNL should be underlined), STATE → INTRNL, and then 2 to save the current analyzer settings in instrument state 2. If the measurement is repeated later, retrieve the analyzer settings with **[RECALL]**, INTRNL → STATE, and 2.

**Note**

If you want to prevent the analyzer from taking a sweep before executing the FFT function, place trace A in the view mode.



9. Press **[MEAS/USER]** and FFT MEAS. The spectrum analyzer performs a fast Fourier transform. The frequency-domain data appears on the screen.
10. A marker is automatically placed on the carrier at the 0 Hz reference (at the left edge of the graticule). Press **MARKER DELTA** and turn the knob to the modulation to determine the frequency and amplitude difference from the carrier. See Figure 2-29.



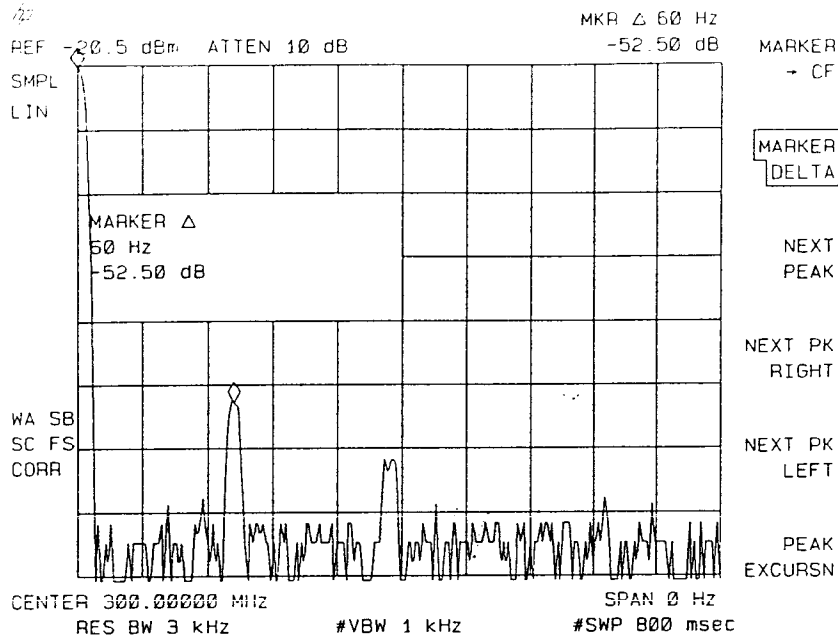



Figure 2-29. Using the FFT Function

The results of the FFT function are displayed on the analyzer screen. The carrier appears at the left edge of the graticule with the modulation sidebands, and any distortion appearing along the horizontal graticule. The left edge of the graticule represents 0 Hz relative to the carrier. The right edge represents the maximum FFT frequency calculated (250 Hz), which is 200 divided by the sweep time. (See Figure 2-29.) The amplitude relationships among the carrier, sidebands, and distortion components are the same as they would be if the components were displayed with swept-tuned operation in log mode, 10 dB per division.

**Note**  The graticule annotation describes the settings before the FFT (linear mode, center frequency 300 MHz, span 0 Hz), and the marker annotation describes the settings after the FFT (log mode, signal at 60 Hz, maximum frequency is 250 Hz).

11. Press **(MKR)**, **MARKERS OFF** to turn off markers before proceeding with other tests.

**Note**  If the markers are not turned off after using **FFT MEAS**, they will not work as expected in other settings.

12. To repeat the test, you must first clear the screen data by pressing **(TRACE)** and **CLEAR WRITE A**. Recall the instrument state by pressing **(RECALL)**, **INTRNL -> STATE**, and then 2. Then repeat step 9.

---

## Measuring Signals Near Band Boundaries Using Harmonic Lock

---

### Note

This application should only be performed using an HP 8592B, HP 8593A, or HP 8595A.



When measuring signals at or near a band crossing, use the lowest band having a specified upper frequency limit that will include the signal of interest. See Table 1-3 in the Installation and Verification Manual for your instrument for harmonic band specifications. Using harmonic lock, and choosing the lowest possible band to analyze a signal, ensures the best specified measurement accuracy.

To lock onto a specific harmonic, press **SPAN**, **BAND LOCK**, **BND LOCK ON OFF** (so that ON is underlined), or select a band (see Table 1-3 in Chapter 1 of the Installation and Verification Manual for your instrument for band specifications). After setting the harmonic lock, only center frequencies and spans within the frequency band of the harmonic may be entered. The span is automatically reduced to accommodate a center frequency specified near the end of the band range.

### Example:

1. Connect 100 MHz COMB OUT to the analyzer input.
2. Press **PRESET** and then the following keys:

**AUX CTRL** **COMB GEN ON OFF (ON)**  
**FREQUENCY** 3 **GHz**  
**SPAN** 350 **MHz**  
**BAND LOCK** **BND LOCK ON OFF (ON)**

3. Place a marker on the farthest peak to the left by using the **PEAK SEARCH** key.
4. Press **MARKER DELTA**, **NEXT PK RIGHT**, **NEXT PK RIGHT** to show the frequency and amplitude difference between the two comb teeth.

You will see three comb teeth on your display. The analyzer is locked in band 1 and will not allow multiband sweeps. See Figure 2-30.

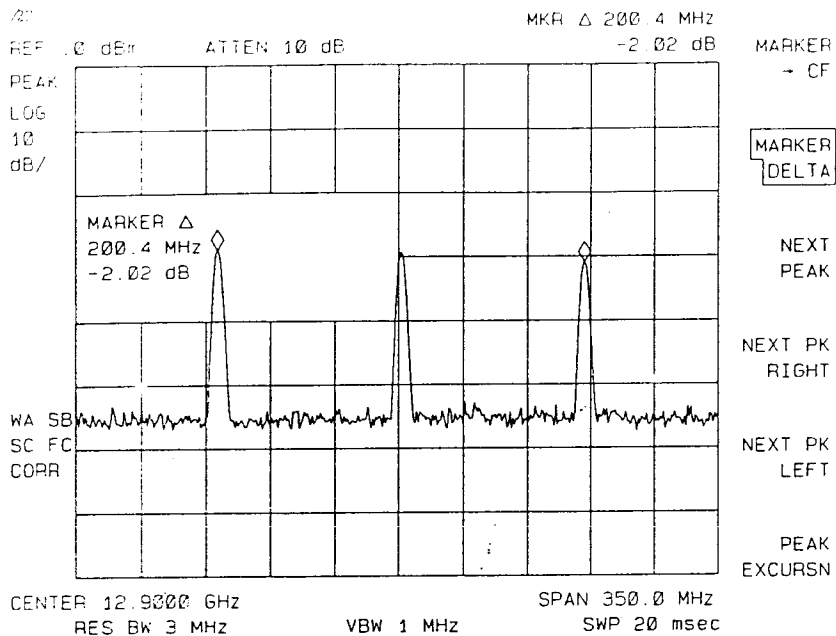

Figure 2-30. Using Harmonic Lock

5. To see a multiband sweep, press the following keys:

**MKR** **MARKERS OFF**

**SPAN** **BAND LOCK BND LOCK ON OFF (OFF)**

6. Place a marker on the farthest peak to the left by pressing **PEAK SEARCH**.

7. Press **MARKER DELTA**. Use **NEXT PK RIGHT** to place a marker on the farthest peak to the right. The marker readout displays the frequency and amplitude difference between the two comb teeth. See Figure 2-31.

**Note** The comb frequencies have a 100 MHz spacing.



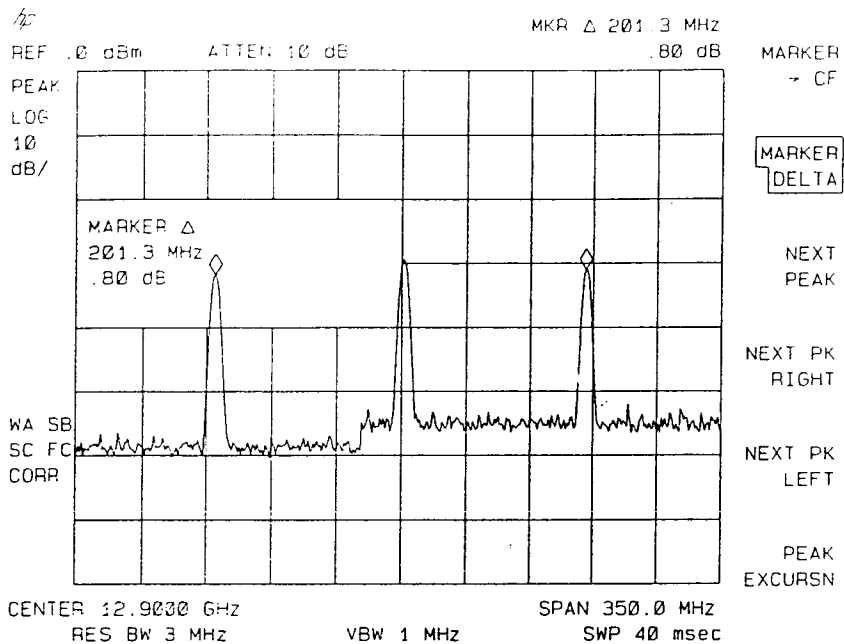

Figure 2-31. Harmonic Locking Off

## Using the Comb Generator to Perform More Accurate Frequency Measurements

**Note** This application should only be performed using an HP 8592B.



The spectrum analyzer has a built-in comb generator that can be connected temporarily to verify frequency accuracy. To identify a signal with the best frequency accuracy provided by the analyzer, use CORRECT TO COMB.

### Example:

1. Set the analyzer to a state where your signal is displayed in a span  $>17$  MHz and  $\leq 400$  MHz. The span should be wide enough to include a comb tooth; however, the narrowest span assures the best accuracy.

In Figure 2-32, the known signal is 4050.0 MHz, and is measured as being 4050.8 MHz.

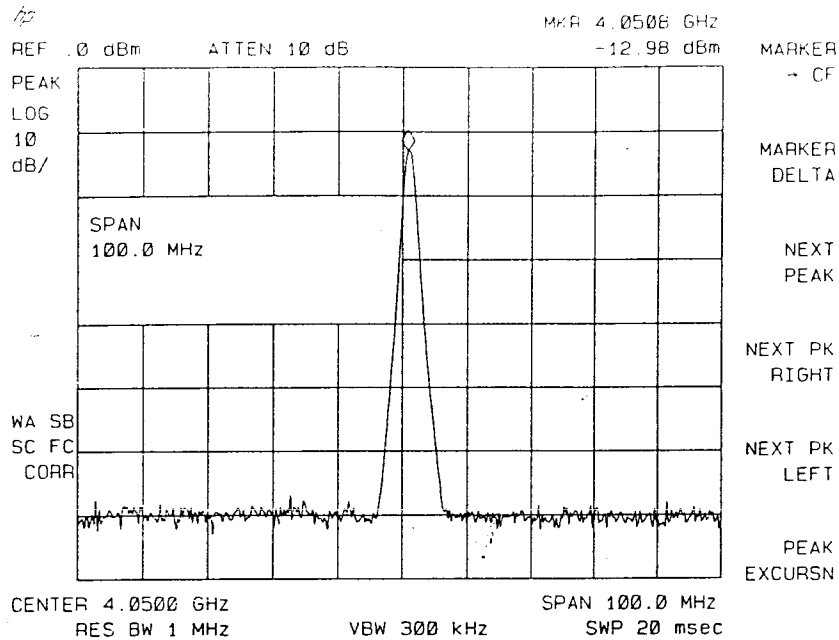
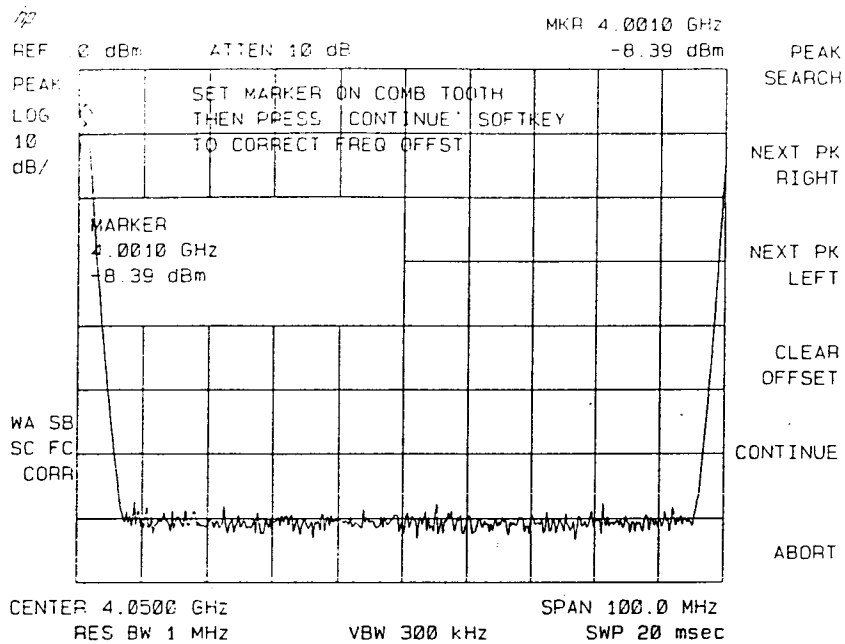

Figure 2-32. Measuring an Input Signal

2. Disconnect the input signal, and connect the 100 MHz COMB OUT to the analyzer input.
3. Press **AUX CTRL**, **COMB GEN ON OFF (ON)**, then **CORRECT TO COMB**. The marker is activated and the menu for the correct to comb routine is displayed. The message **SET MARKER ON COMB TOOTH THEN PRESS CONTINUE SOFTKEY TO CORRECT FREQ OFFST** is displayed. See Figure 2-33.
4. Use **PEAK SEARCH**, **NEXT PK RIGHT** or **NEXT PK LEFT**, or use the knob to place the marker on the comb tooth that is nearest to the location of the input signal.



**Figure 2-33. Using the Correct to Comb Function**

5. Press **CONTINUE** or you may end the routine at this point by pressing **ABORT**.
6. If you pressed **CONTINUE**, the analyzer automatically calculates and puts in a frequency offset. The frequency offset in the analyzer is automatically set for the best accuracy available in the current span and center frequency.
7. Reconnect the input signal and use the marker to read the corrected frequency.

The frequency offset is displayed at the bottom center of the screen. The known signal is measured as being 4050.0 MHz. See Figure 2-34.

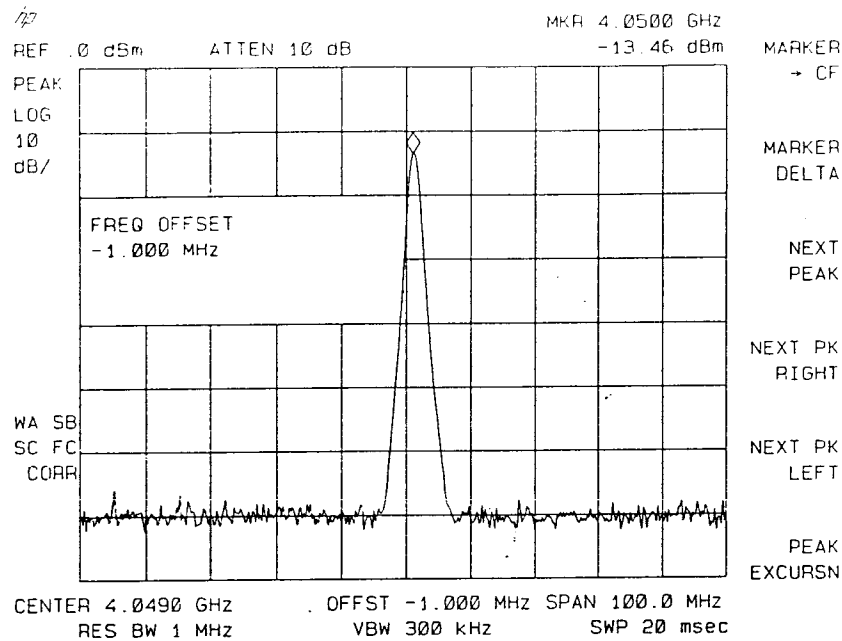

**Figure 2-34. Frequency Readout with a Frequency Offset**

**Note**



If you change the center frequency or span, you must recorrect the frequency. Note that the analyzer's frequency offset has been used to help calibrate the display, and remember to reset the offset before making other measurements. To clear the offset, use **CLEAR OFFSET**, or press the **PRESET** key.

**Note**



For center frequencies less than 50 MHz, the local oscillator can be used as a referenced signal rather than a comb tooth to obtain better accuracy. The Correct-to-Comb function is recommended for spans 17 to 400 MHz, and is not useable in multibands. Refer to Table 1-3 for more information. When using **CORRECT TO COMB** in band 0, 20 dB of attenuation or greater should be used; otherwise the comb generator's power level overloads the first converter.

## Stimulus-Response Measurements

### Note



This application should only be performed using an HP 8590B or HP 8591A with Option 010 or 011, or using an HP 8593A, HP 8594A, or HP 8595A with Option 010.

### What Are Stimulus-Response Measurements?

Stimulus-response measurements require a source to stimulate a device under test (DUT), a receiver to analyze the frequency-response characteristics of the DUT, and, for return-loss measurements, a directional coupler. Characterization of a DUT can be made in terms of its transmission or reflection parameters. Examples of transmission measurements include flatness and rejection. A reflection measurement is return loss.

A spectrum analyzer combined with a tracking generator forms a stimulus-response measurement system. With the tracking generator as the swept source and the spectrum analyzer as the receiver, operation is analogous to a single-channel scalar network analyzer. A narrow-band system has a wide dynamic measurement range, but the tracking generator's output frequency must be made to precisely track the spectrum analyzer's input frequency. This wide dynamic range will be illustrated in the following example. Figure 2-35 shows the block diagram of a spectrum-analyzer and tracking-generator system.

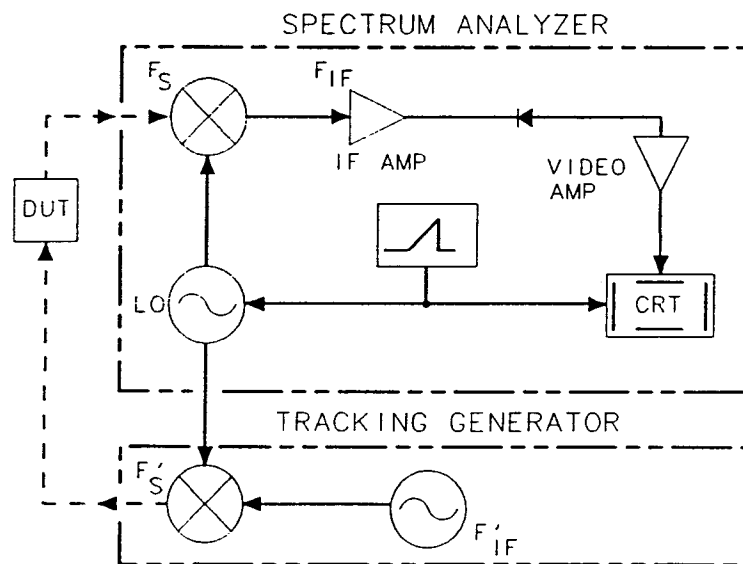

Figure 2-35. Block Diagram of a Spectrum-Analyzer/Tracking-Generator Measurement System



## Spectrum Analyzer Functions Used

The procedure below describes how to use the built-in tracking generator system of the HP 8591A Option 010 Spectrum Analyzer to measure the rejection of a low-pass filter—a type of transmission measurement. Illustrated in this example are the functions in the tracking-generator menu, such as adjusting the tracking-generator output power, source calibration, and normalization. Conducting a reflection measurement is similar and will not be covered. Refer to the HP Spectrum Analyzer Seminar, or Application Note 150-7, for more information.

## Stepping Through the Measurement

There are four basic steps in performing a stimulus-response measurement, whether it be a transmission or reflection measurement: set up the spectrum analyzer settings, calibrate, normalize, and measure.

1. If necessary, perform the self-calibration routine for the tracking generator described in “Performing the Tracking Generator Self-Calibration Routine” in Chapter 1.
2. To measure the rejection of a low-pass filter, connect the equipment as shown in Figure 2-36. This example uses a filter with a cut-off frequency of 300 MHz as the DUT.

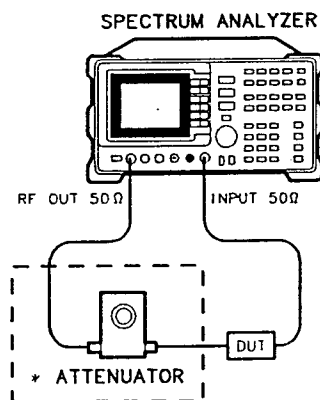

• HP 8590B, HP 8594A, or HP 8595A only.

Figure 2-36. Transmission Measurement Test Setup

3. Activate the tracking generator menu by pressing **AUX CTRL** and **TRACK GEN**. To activate the tracking-generator power level, press **SRC PWR ON OFF** until **ON** is underlined. See Figure 2-37.

### Caution



Excessive signal input may damage the DUT. Do not exceed the maximum power that the device under test can tolerate.

**Note**



This note applies only to an HP 8591A with Option 010 or 011.

To reduce ripples caused by source return loss, use 10 dB or greater tracking generator output attenuation. Tracking generator output attenuation is normally a function of the source power selected. However, it may be controlled by **SRC ATN AUTO MAN**. Refer to Table 1-2 in the Installation and Verification Manual for your instrument for more information on the relationship between source power and source attenuation.

Output attenuation is not available when using an HP 8590B, HP 8593A, HP 8594A, or HP 8595A, therefore, an external attenuator must be used.

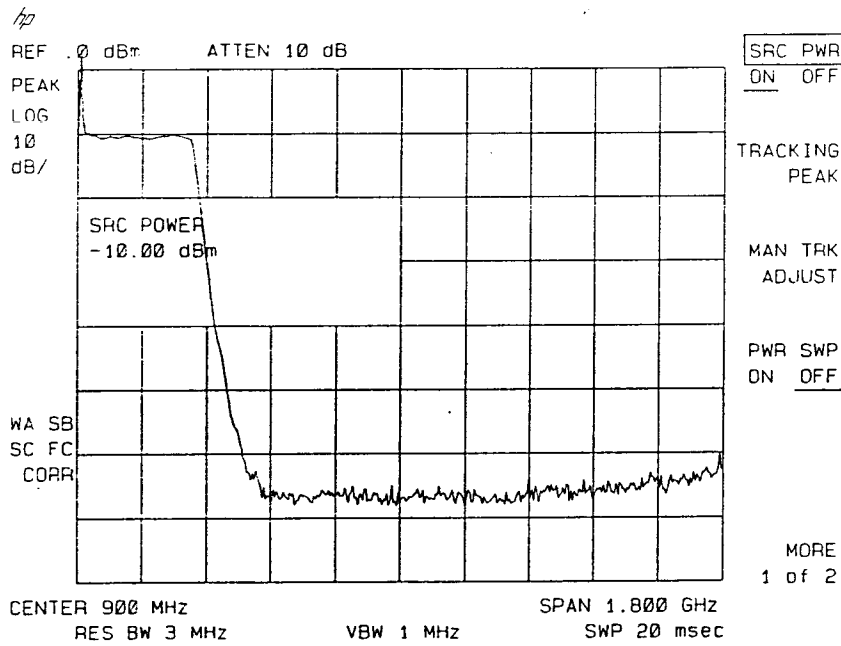

**Figure 2-37. Tracking-Generator Output Power Activated**

- Put the sweep time of the analyzer into stimulus-response auto-coupled mode by pressing **MORE 1 OF 2**, then **SWP CPLG SR SA** until **SR** is underlined. In stimulus-response mode, the auto-coupled sweep times are usually much faster for swept-response measurements.

**Note**



In the stimulus-response mode, the **Q** (reactance versus resistance) of the DUT can determine the fastest rate at which the analyzer can be swept. To determine whether the analyzer is sweeping too fast, slow the sweep time and note whether there is a frequency or amplitude shift of the trace. Continue to slow the sweep time until there is no longer a frequency or amplitude shift.

- Since we are only interested in the rejection of the low-pass filter, tune the spectrum analyzer's center frequency so that the rolloff of the filter comprises the majority of the trace on the display (see Figure 2-38).

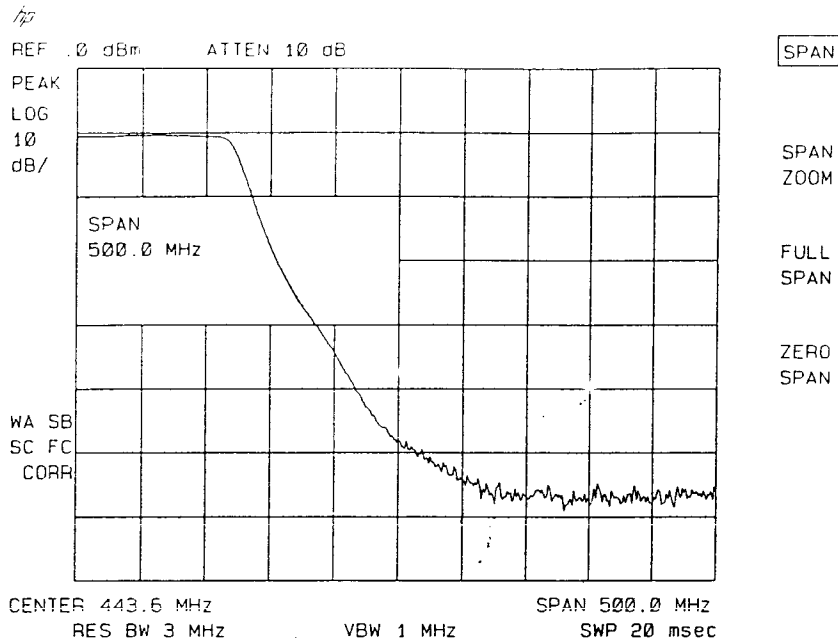

**Figure 2-38. Spectrum Analyzer Settings According to the Measurement Requirement**

- Decrease the resolution bandwidth to increase sensitivity, and narrow the video bandwidth to smooth the noise. In Figure 2-39, the resolution bandwidth has been decreased to 10 kHz.

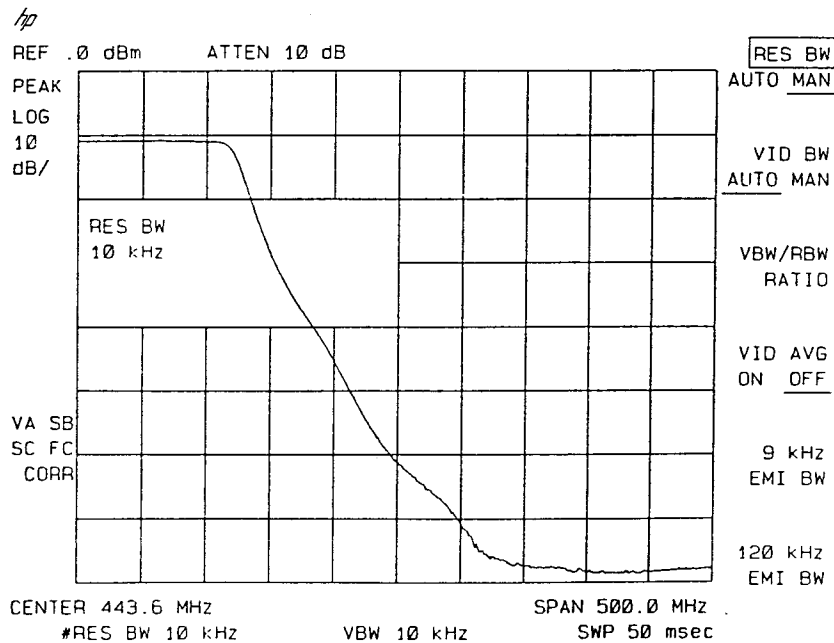

**Figure 2-39. Decrease the Resolution Bandwidth to Improve Sensitivity**

Adjusting the resolution bandwidth may result in a decrease in amplitude of the signal. This is known as a tracking error. Tracking errors occur when the tracking generator's

output frequency is not exactly matched to the input frequency of the spectrum analyzer. Tracking errors are most notable when using narrow resolution bandwidths. Tracking error can be compensated manually or automatically. In narrow bandwidths, the manual method of adjusting the tracking is usually faster than the automatic tracking adjustment. To compensate for the tracking error manually, press **AUX CTRL**, **TRACK GEN**, **MAN TRK ADJUST**, then use the knob to adjust the trace for the highest amplitude. To compensate for the tracking error automatically, press **AUX CTRL**, **TRACK GEN**, **TRACKING PEAK**.

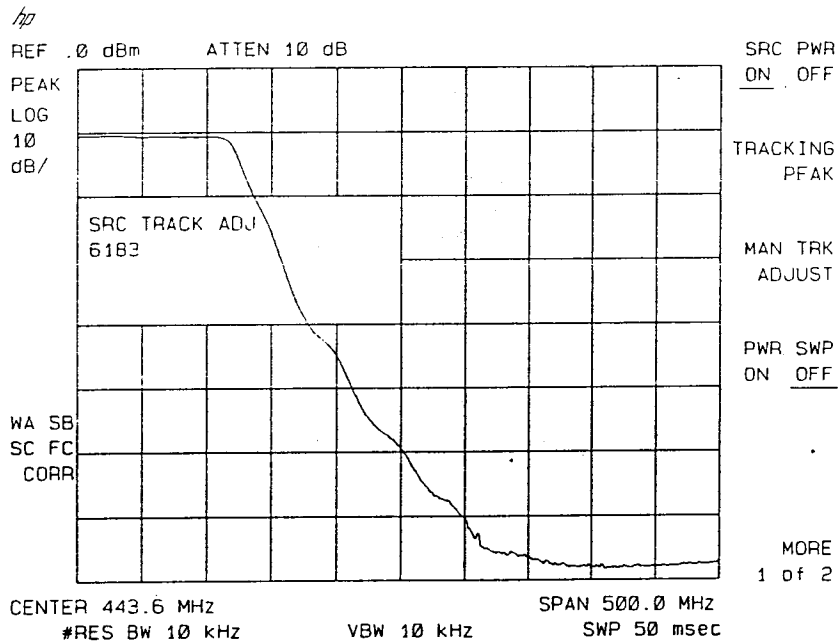

**Figure 2-40. Manual Tracking Adjustment Compensates for Tracking Error**

**Note**



If the automatic tracking routine is activated in a narrow resolution bandwidth, it usually is not necessary to use the tracking adjust again when increasing the resolution bandwidth.

7. To make a transmission measurement accurately, the frequency response of the test system must be known. To measure the frequency response of the test system, connect the cable (but not the DUT) from the tracking generator output to the analyzer input. Press **TRACE**, **TRACE A B C** (so B is underlined), **CLEAR WRITE B**, **BLANK B**. The frequency response of the test system is now stored in trace B.
8. To normalize, reconnect the DUT to the analyzer. Press **TRACE**, **MORE 1 of 3**, **NORMLIZE ON OFF** until ON is underlined. Press **NORMLIZE POSITION** to activate the display line. This display line marks the normalized reference position, or the position where 0 dB insertion loss (transmission measurements) or 0 dB return loss (reflection measurements) will normally reside. Using the knob results in a change in the position of the normalized trace, within the range of the graticule.

Normalization eliminates the frequency response error of the test system. When normalization is on, trace math is being performed on the active trace. The trace math performed is trace A minus trace B plus the display line, with the result placed into trace A. Remember that trace A contained the measurement trace, trace B contained the stored calibration trace, and DL (display line) represents the normalized reference position. Note that the units of the reference level, dB, reflect this relative measurement.

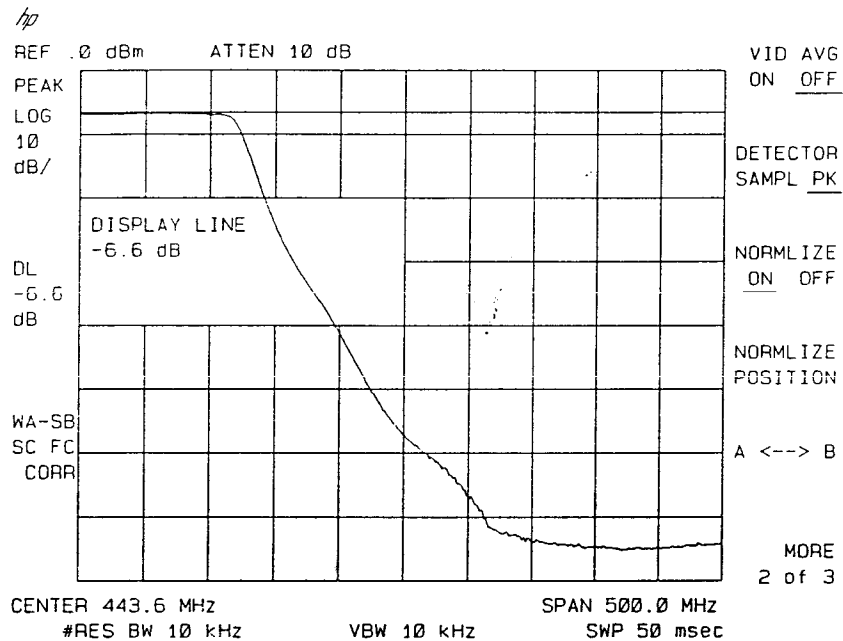

Figure 2-41. Normalized Trace

- To measure the rejection of the filter at a given frequency, press **(MKR)**, and enter the frequency. For example, enter 350 MHz. The marker readout displays the rejection of the filter at 350 MHz (see Figure 2-42).

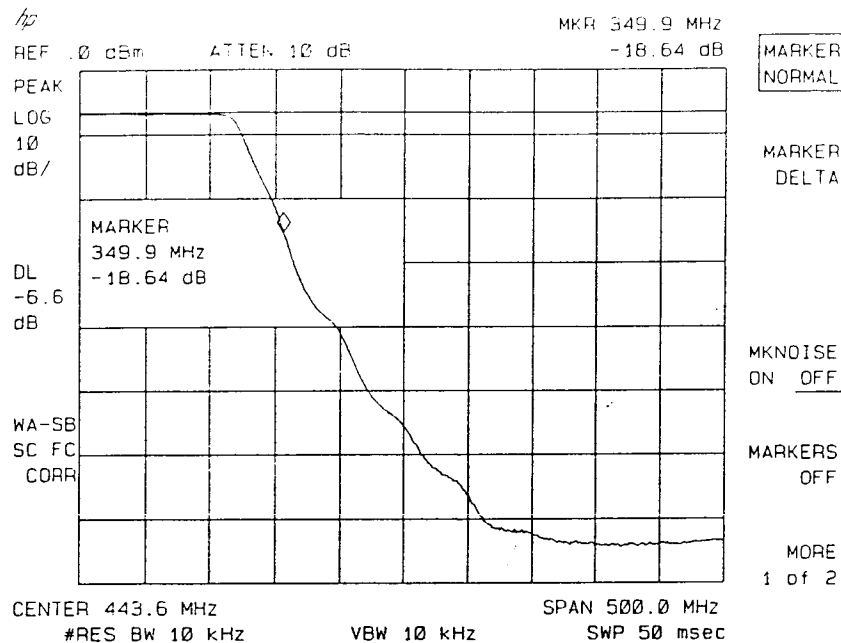

Figure 2-42. Measure the Rejection Range with Delta Markers

### Tracking Generator Unleveled Condition

When using the tracking generator, the message **TG UNLVL** may appear. The **TG UNLVL** message indicates that the tracking generator source power (**SRC PWR ON OFF**) could not be maintained at the user-selected level during some portion of the sweep. If the unlevel condition exists at the beginning of the sweep, the message will be displayed immediately. If the unlevel condition occurs after the sweep begins, the message will be displayed after the sweep is completed. A momentary unlevel condition may not be detected when the sweep time is small. The message will be cleared after a sweep is completed with no unlevel conditions.

The unlevel condition may be caused by any of the following:

- Start frequency is too low or the stop frequency is too high. The unlevel condition is likely to occur if the true frequency range exceeds the tracking generator frequency specification (especially the low frequency specification). The true frequency range being swept may be significantly different than the start or stop frequency annotations indicate, depending on other spectrum-analyzer settings, especially the span (see Table 1-1 in the Installation and Verification Manual for your instrument). For better frequency accuracy, use a narrower span.
- Tracking peak may be required (use **TRACKING PEAK**).
- Source attenuation may be set incorrectly (select **SRC ATN MAN AUTO (AUTO)** for optimum setting).
- The source power may be set too high or too low, use **SRC PWR ON OFF** to reset it.

## Demodulating and Listening to an AM or FM Signal

### Note



This application should only be performed using an HP 8591A, HP 8593A, HP 8594A, or HP 8595A with Option 102 or 103.

The functions listed in the menu under **DEMODO** allow you to demodulate and hear signal information displayed on the spectrum analyzer. Simply place a marker on a signal of interest, activate AM or FM demodulation, and then listen.

### Example:

1. Connect an antenna to the spectrum analyzer input.
2. Select a frequency range on the analyzer, such as the range for FM radio broadcasts. For example, the frequency range for FM broadcasts in the United States is 88 MHz to 108 MHz. Press **PRESET**, **FREQUENCY**, **START FREQ**, 88 **MHz**, **STOP FREQ**, 108 **MHz**.
3. Place a marker on the signal of interest by using **PEAK SEARCH** to place a marker on the highest-amplitude signal, or by pressing **MKR**, **MARKER NORMAL** to move the marker to a signal of interest.
4. Press **AUX CTRL**, **DEMODO**, **DEMODO ON OFF** (so that ON is underlined), and **DEMODO AM FM** (so that FM is underlined). The **SPEAKER ON OFF** function is set to ON by the preset function. Use the front-panel volume control to control the speaker's volume.

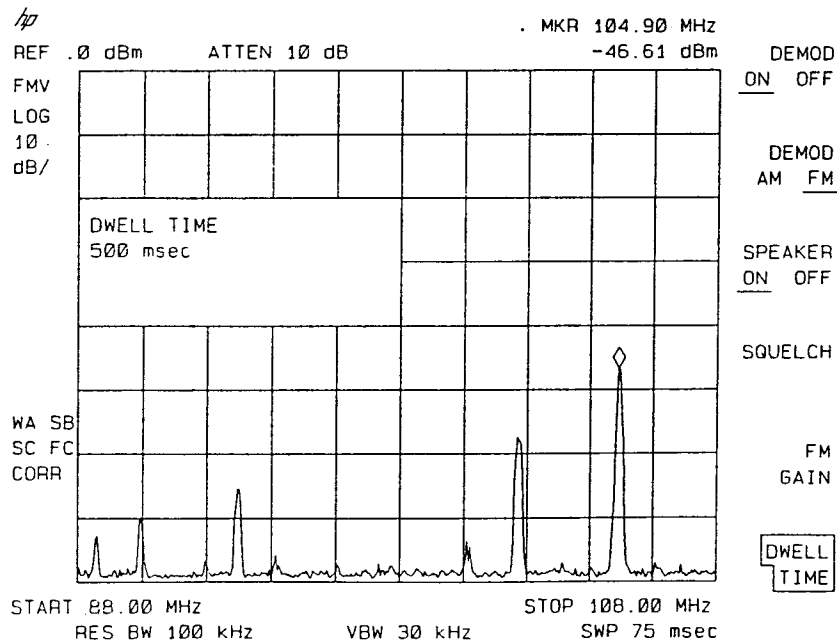

Figure 2-43. Demodulation of an FM Signal

5. The signal is demodulated at the marker's position for the duration of the dwell time. Use the step keys, knob, or number/units keypad to change the dwell time. For example, press the step-up key (**▲**) twice to increase the dwell time to 2 seconds.

## 2-46 Analyzer Measurements and Applications

- The peak search functions can be used to move the marker to other signals of interest. Press **PEAK SEARCH** to access **NEXT PEAK**, **NEXT PK RIGHT**, or **NEXT PK LEFT**.

**Example:** The signal can be continuously demodulated if the analyzer is in zero span.

- Place the marker on a signal of interest as in steps 1 through 3 of the previous example.
- If the signal of interest is the highest-amplitude on-screen signal, set the frequency of the signal to center frequency using **SIGNAL TRACK**. If it is not the highest-amplitude on-screen signal, move the signal to center screen by pressing **MKR ->**, **MARKER -> CF**.
- If signal track is on, press **SPAN** and **1 MHz** to reduce the span to 1 MHz. If signal track is not used, use the step-down key (**▼**) to reduce the span and use **MARKER -> CF** to keep the signal of interest at center screen.
- Set the span to zero by pressing **ZERO SPAN**. (**ZERO SPAN** turns off the signal track function.)
- Change the resolution bandwidth to 100 kHz. Press **BW**, **100 kHz**.
- Set the signal in the top two divisions of the screen by changing the reference level. Press **AMPLITUDE**, and then the step-down key (**▼**) until the signal is in the top two divisions.
- Press **AUX CTRL**, **DEMODO**, **DEMODO ON OFF** (so that **ON** is underlined), **DEMODO AM FM** (so that **FM** is underlined). The **SPEAKER ON OFF** function is set to **ON** by the preset function. Use the front-panel volume control to control the speaker's volume.

For FM demodulation, use **FM GAIN** to adjust the top-to-bottom screen deviation of the signal, using center screen as a reference. FM gain sensitivity is increased by decreasing the FM gain value. As the FM gain sensitivity is increased, the volume is increased. Pressing **SQUELCH** mutes the noise level.

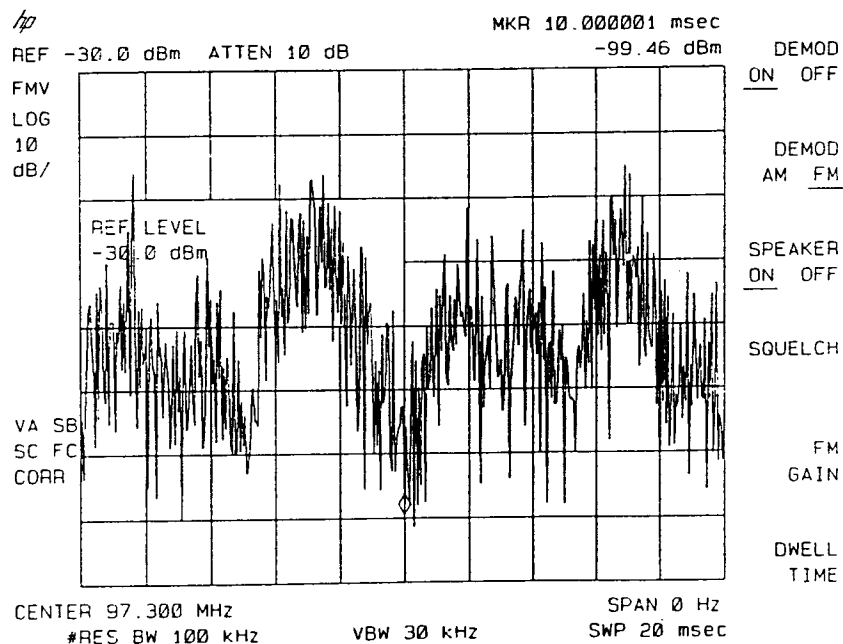

**Figure 2-44. Continuous Demodulation of an FM Signal**



## Triggering on a Selected Line of a Video Picture Field

### Note



This application should only be performed using an HP 8591A, HP 8593A, HP 8594A, or HP 8595A with Option 301 (Options 101 and 102 combined).

With Option 301, you can trigger on a TV picture carrier signal. This example enables you to view a test signal transmitted during vertical retrace when the TV screen is blanked.

1. Press **PRESET**.
2. Set the frequency of a picture carrier signal to center frequency.
3. Press **TRIG** and **TV TRIG**. If the spectrum analyzer is in a nonzero span, **TV TRIG** sets the amplitude scale to linear, places a marker on the signal peak, moves the marker to the reference level, changes the detector to sample, sets the sweep time to 100  $\mu$ s, sets the resolution bandwidth to 1 MHz, and sets the span to 0 Hz. The TV line number is the active function. The preset function sets the analyzer to trigger on an odd field of a video format and TV line number 17.

The sweep time of 100  $\mu$ s allows you to view two TV lines, line 17 and part of line 18.

The multiburst is on TV line number 17, and the composite is on TV line number 18.

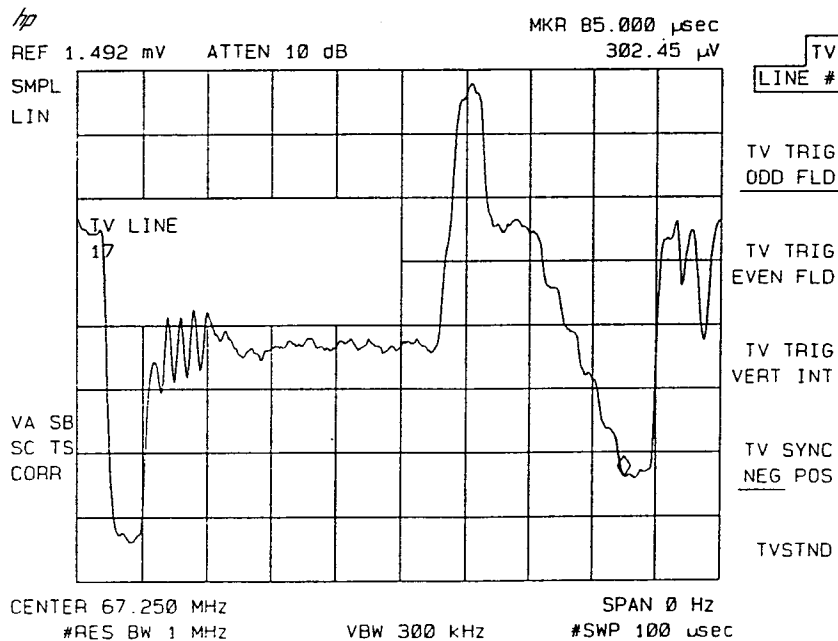
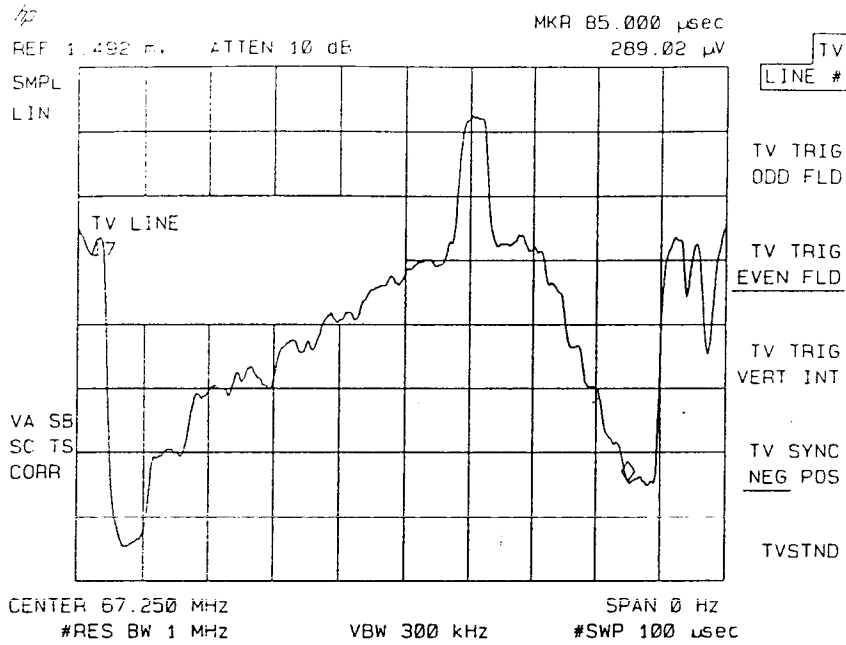

Figure 2-45. Triggering on an Odd Field of a Video Format

4. Press **TV TRIG EVEN FLD** to trigger on an even field of a video format.



**Figure 2-46. Triggering on an Even Field of a Video Format**

The default video format is NTSC. Press **TVSTND**, then **PAL-M**, **PAL**, or **SECAM-L** to select a different video format. For noninterlaced video formats, press **TV TRIG VERT INT**.

**Note**



The selection of video format (**NTSC**, **PAL-M**, **PAL**, or **SECAM-L**) automatically selects the video modulation (negative or positive).

## Making Reflection Calibration Measurements

Typically, the calibration standard for reflection measurements is a short circuit connected at the reference plane (the point at which the test device will be connected—see Figure 2-47). A short circuit has a reflection coefficient of 1 (0 dB return loss); it thus reflects all incident power and provides a convenient 0 dB reference.

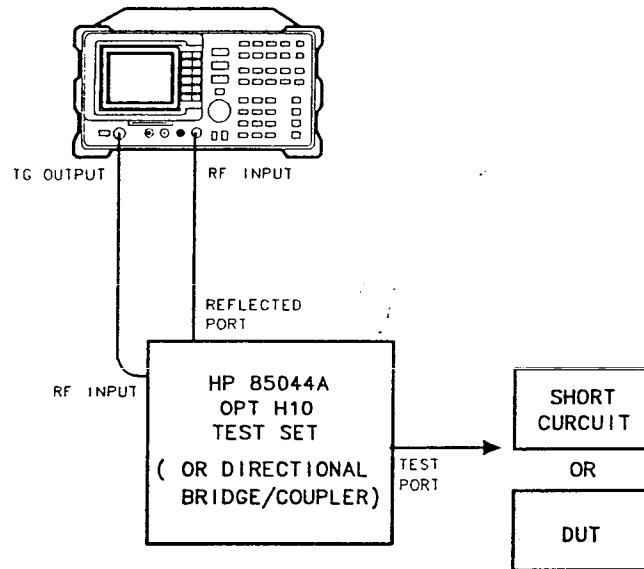

Figure 2-47. Reflection Measurement Short Calibration Test Setup

Example: Measure the return loss of a filter.

### Reflection Calibration

#### Note



The spectrum analyzer center frequency and span for this measurement can easily be set up using the transmission measurement setup. Tune the analyzer so that the passband of the filter comprises a majority of the display, then proceed with the steps outlined below.

1. Connect the DUT to the *test* port of the HP 85044A Test Set (Option H10) or to the *load* port of a directional bridge or coupler. Terminate the unconnected port of the DUT.
2. Connect the tracking generator output of the spectrum analyzer to the *RF input* port of the HP 85044A Test Set (Option H10) or to the *source* port of a directional bridge or coupler.
3. Connect the spectrum analyzer INPUT to the *reflected* port of the HP 85044A Test Set (Option H10), or to the *reflected* port of a directional bridge or coupler.
4. Adjust the spectrum analyzer for measurement conditions or settings. Turn on the tracking generator and set the amplitude level by pressing **AUX CTRL**, **TRACK GEN**, and setting **SRC PWR ON OFF** to ON. Set center frequency, span, and so on.

5. Replace the DUT with a short circuit.
6. Normalize the trace by performing the following functions:
  - a. Press **TRACE**, select B using TRACE A B C, then CLEAR WRITE B to display the reference trace in B.
  - b. Press **BLANK B** to store the reference trace in B.
  - c. Press **MORE 1 OF 3**, then set **NORMLIZE ON OFF** to ON to activate the trace A minus trace B function, and display the results in trace A for each sweep. The normalized trace or flat line represents 0 dB return loss.

## Measuring the Return Loss

### Note



If possible, use a coupler or bridge with the correct test port connector for both calibrating and measuring. Any adapter between the test port and DUT degrades coupler/bridge directivity and system source match. Ideally, you should use the same adapter for the calibration and the measurement. Be sure to terminate the second port of a two-port device.

7. After calibrating the system with the above procedure, reconnect the filter in place of the short circuit without changing any spectrum analyzer settings.
8. Use the marker to read return loss. Press **MKR** and position the marker with the knob to read the return loss at that frequency. See Figure 2-48.

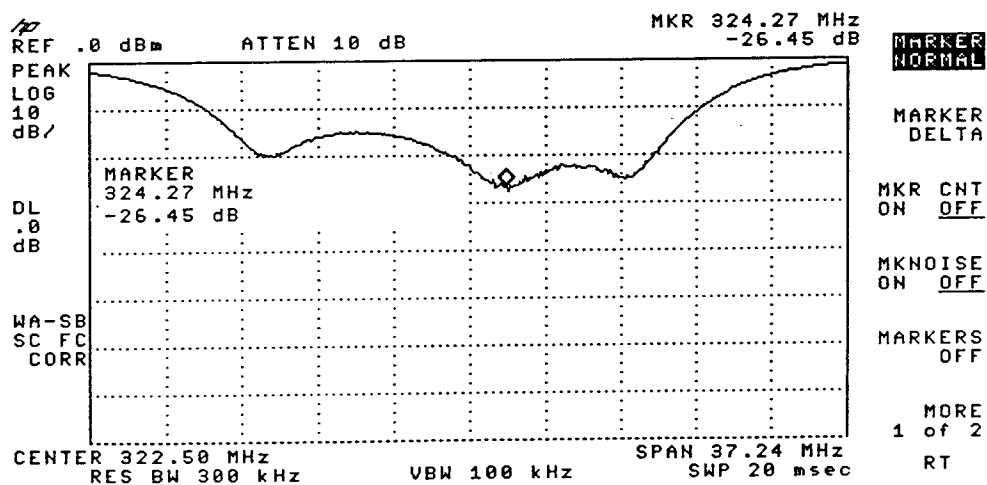

Figure 2-48. Measuring the Return Loss of the Filter.

---

## Using the Time-Gated Spectrum Analyzer Capability

---

**Note** This application should only be performed using an Option 105.



---

This section provides the following information:

- Introduces the time-gated spectrum analyzer capability.
- Explains how to use the self-calibration routines with Option 105.
- Explains how to perform a functional check of Option 105.
- Explains how to use Option 105 to view a pulsed RF signal.

---

**Note** For more information about how to use Option 105 with other types of signals, see the product note that is shipped with Option 105.



---

### Introducing the Time-Gated Spectrum Analyzer Capability

As the spectrum analyzer takes a measurement sweep, it displays a specific frequency as it sweeps across the frequency range of the spectrum analyzer. Since signals can vary in time, the spectrum analyzer can miss an event at one frequency because it is sweeping at a different frequency. With Option 105, the time-gated spectrum analyzer capability, the spectrum analyzer can provide a “window” of what is going on with a signal at any specific time, since an analyzer with Option 105 has the capability to selectively acquire data based on an external trigger signal. The “window” represents a periodic timed event where data acquisition is enabled.

The following figures demonstrate how the time-gating can view an event. For example, you could have two signals at the same frequency. If the two signals vary in time, you can use an oscilloscope to determine whether there are two signals (see Figure 2-49). However, you could not use a standard spectrum analyzer to determine whether there were two signals at the same frequency. By using the time-gate functions of Option 105, you can use a spectrum analyzer to measure each of the two signals separately. (See Figure 2-50.)

---

**Note** When Option 105 is enabled, it interrupts the internal signal path of the spectrum analyzer, so several analyzer functions may not be available under all conditions. These conditions include: marker noise (**MKNOISE ON OFF**), sample detection while in the frequency span mode, quasi-peak detection (Option 103), and AM/FM demodulation and TV sync trigger (Option 102). The marker counter function (**MKR CNT ON OFF**) is not directly affected by the operation of Option 105, but many signals that are appropriate for time-gating (for example, pulsed RF signals) will not be counted correctly by the marker counter function.

---

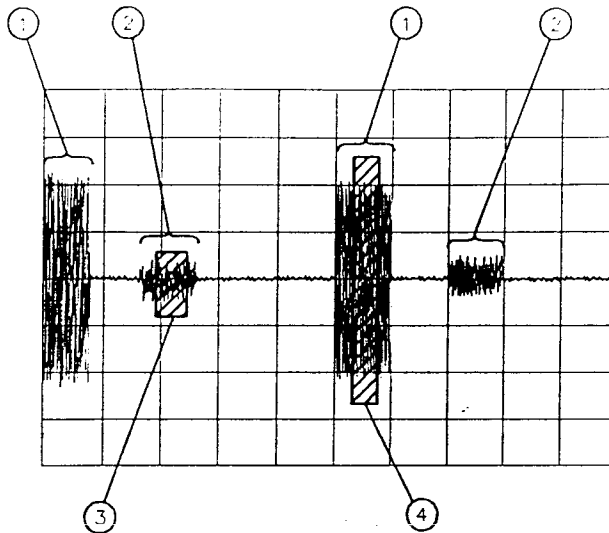

Figure 2-49. Viewing Time-Sharing of a Frequency with an Oscilloscope

Item	Description of Items in Figure 2-49	Item	Description of Items in Figure 2-49
1	First signal.	3	When the Option 105 gate will be on to view the second signal.
2	Second signal.	4	When the Option 105 gate will be on to view first signal.

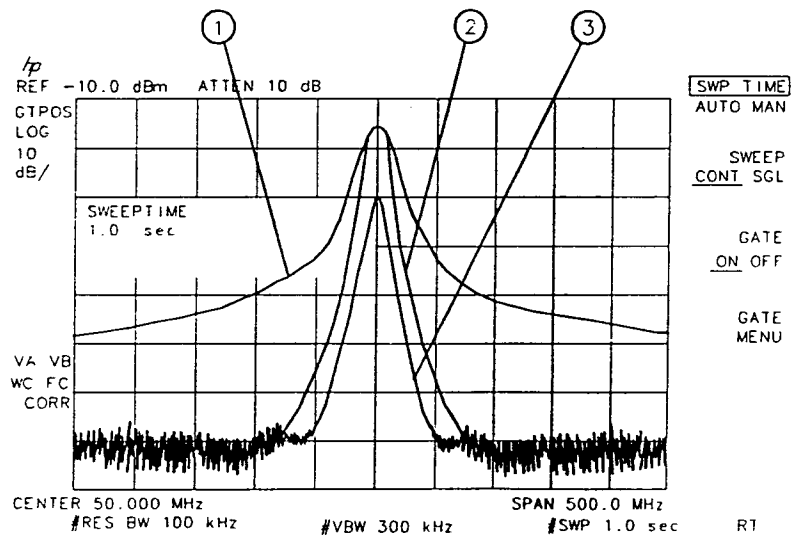

Figure 2-50. Viewing Time-Sharing of a Frequency with a Spectrum Analyzer

Item	Description of Items in Figure 2-50
1	Trace display without the time-gate function on.
2	Trace display of the first signal, with the time gate on.
3	Trace display of the second signal, with the time gate on.

**Note**



If you have Option 101 and Option 105 installed in your spectrum analyzer, the last two divisions of the trace display are unusable in sweep times of less than 20 ms and in a video bandwidth of 3 MHz.

**Using the Self-Calibration Routines with Option 105**

The spectrum analyzer's self-calibration routines (initiated by pressing **CAL AMPTD** or **CAL FREQ & AMPTD** ) should be performed prior to using the Option 105 functions. Use the following procedure to perform the self-calibration routines and to check the results of the self-calibration routines.

**Note**



Be sure that the GATE TRIGGER INPUT connector (on the spectrum analyzer's rear panel) is not connected to anything while performing the spectrum analyzer's self-calibration routines.

1. Remove the cable from the GATE TRIGGER INPUT connector.
2. Connect the CAL OUT connector to the spectrum analyzer input connector with the calibration cable.
3. Press **CAL**. Press either **CAL FREQ & AMPTD** (to perform the frequency and amplitude self-calibration routines) or **CAL AMPTD** (to perform the amplitude self-calibration routine).
4. When the self-calibration routines have successfully completed, press **CAL STORE**.
5. Press **CAL**, **MORE 1 of 3**, **MORE 2 of 3**, **SERVICE DIAG**, then **DISPLAY CAL DATA**.
6. Verify that the number in the first column, in the 9th position down, is between 0.98 and 1.0. See Figure 2-51.

MISC-FREQ	RL-VERN	ERR	BW-AMP	LC-XTAL	SGAIN	RFATN	CAL FREQ & AMPTD
300000000	200	0.00	0.00	0 255	0.02	0.03	CAL
247600000	200	0.00	0.00	0 255	0.00	0.00	FREQ
53766809	200	0.00	0.00	0 255	0.31	0.02	
21273139	200	0.00	0.00	0 255	0.28	-0.02	CAL
0.000201900	200	0.00	-0.04	0 130	0.36	-0.12	AMPTD
0.000002024	129	0.02	0.53	0 255	0.32	-0.15	
1058311612	129	0.02	-0.06	0 221	0.31	-0.20	
0.875468969	129	0.02	-0.04	0 165	0.30	0.00	
0.997318149	129	0.02	-0.04	0 100	0.24		
0	129	0.02	-0.09	0 26	0.31		
0.118091673	200	0.00	-0.37	39 255			
0	200	0.00	-0.27	97 255			CAL
-21	200	0.00	-0.24	160 255			STORE
1	200	0.00	-0.23	219 255			
1	200	0.00	-0.21	240 255			
65	31	0.00	-0.39	30 255			MORE
							1 OF 3
							RT

**Figure 2-51. Self-Calibration Data Results**

If the number is not between 0.98 and 1.0, check that the GATE TRIGGER INPUT connector is not connected to anything, then repeat the previous steps of this procedure.

7. Press **PRESET**.

### Performing a Functional Check of Option 105

To check that the time-gated spectrum analyzer capability is operational, perform the following steps:

1. Connect the rear panel HIGH SWEEP IN/OUT connector to the GATE TRIGGER INPUT connector with a short BNC calibration cable. (See Figure 2-52.)

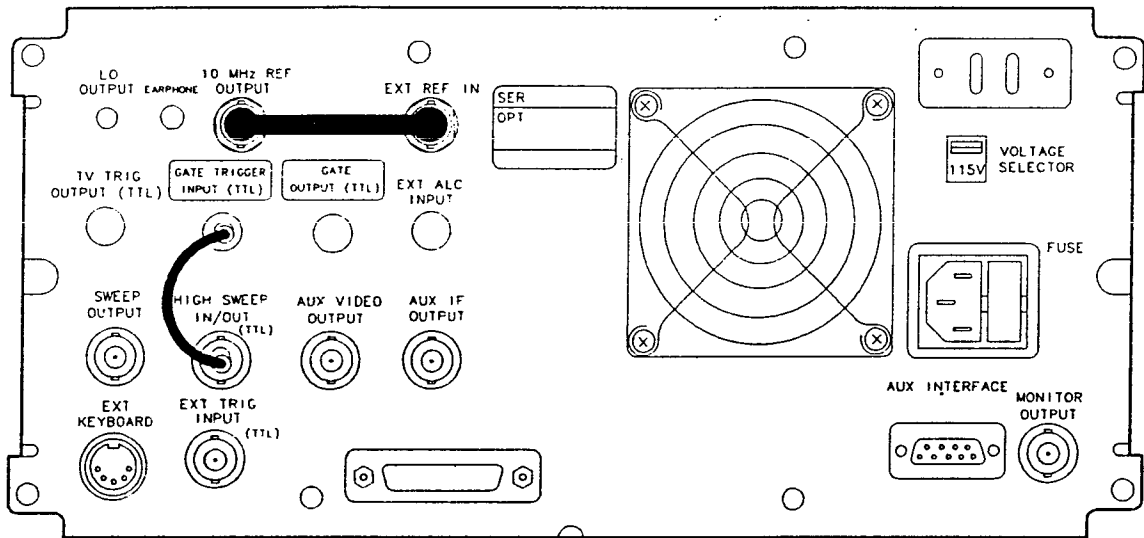

Figure 2-52. Rear Panel Connections for Option 105

2. Press **PRESET**, **FREQUENCY**, 0 **Hz**, **SPAN**, **ZERO SPAN**, **SWEEP**, 200 **ms**, **GATE MENU**, **GATE DELAY**, 60 **ms**, **GATE LENGTH**, 60 **ms**.

The **GATE CTL EDGE LVL** softkey label should have **EDGE** underlined, and **EDGE POL POS NEG** should have **POS** underlined.

3. Press **PREV MENU**, **GATE ON OFF** (so that **ON** is underlined). See Figure 2-53.

#### Note



This procedure offers a qualitative functional check only. Due to several factors, the accuracy of the marker readout of the gate delay and gate length can vary by several milliseconds. For more information about gate timing, see the Characteristics Table in the Installation and Verification Manual for your spectrum analyzer.



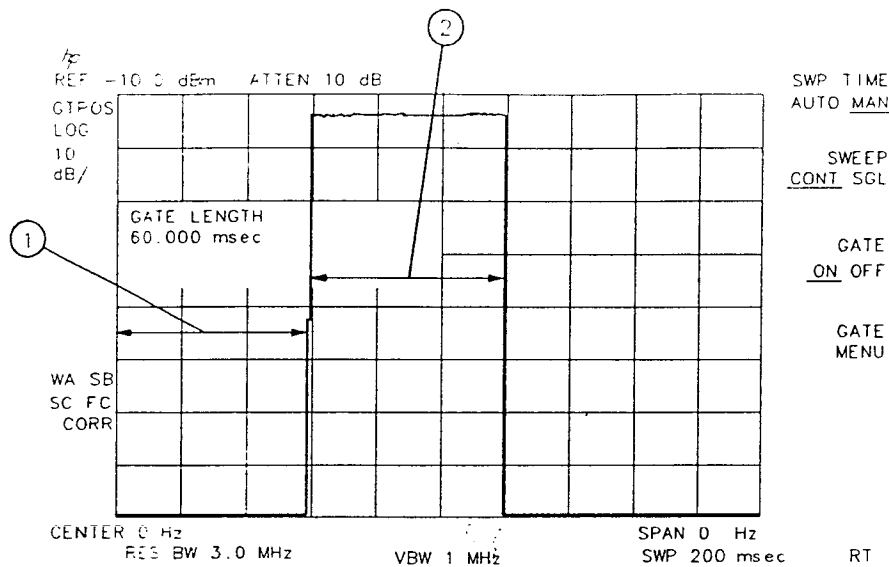

Figure 2-53. Gate On

Item	Description of Items in Figure 2-53
1	Represents the gate delay. The gate is off during the gate delay.
2	Represents the gate length. The gate is on, and the HI SWEEP IN/OUT signal is displayed.

4. To check the gate control function, press **SWEEP**, **GATE MENU**, **GATE CTL EDGE LVL** so that LVL (level) is underlined. (See Figure 2-54.)

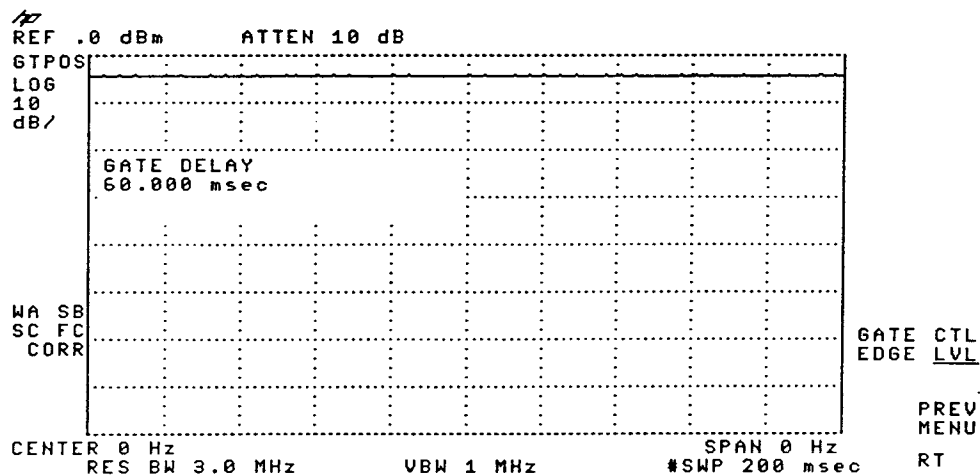

Figure 2-54. Using the Level Gate Control

When the **GATE CTL EDGE LVL** softkey function is set to edge, triggering occurs at the edge of the trigger input. When the **GATE CTL EDGE LVL** softkey function is set to level, the gate is on whenever the trigger input is high. Because the trigger input for this

## 2-56 Analyzer Measurements and Applications

example is the HI SWEEP IN/OUT signal, and HI SWEEP IN/OUT signal is high (+5 V) during every sweep, the level of the signal on screen is high.

Notice that the GATE DELAY, GATE TIME, and EDGE POL NEG POS softkeys are blanked when the gate control is set to level. When the gate control is set to level (LVL), the functions of gate delay, gate length, and edge trigger no longer apply.

### Using the Time-Gated Spectrum Analyzer Capability to View Pulsed RF

This example demonstrates how to use Option 105 to view two different pulsed RF signals. The signals are at the same frequency, but they interleave in time.

To use Option 105 to view the amplitude of a pulsed RF signal accurately, the analyzer settings of the sweep time, resolution bandwidth, video bandwidth, gate delay, and gate length must be set correctly. To set the analyzer settings correctly, you must determine the pulse repetition interval, pulse width, and signal delay (if any) of the pulsed RF signal. Figure 2-55 shows an example of two pulsed RF signals.

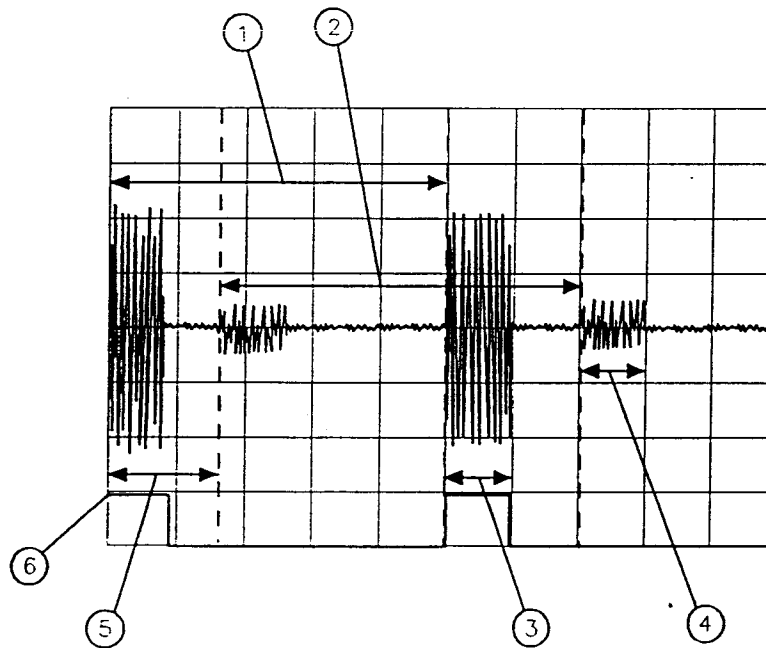

Figure 2-55. Pulse Repetition Interval and Pulse Width (with Two Signals Present)

Item	Description of Items in Figure 2-55
1	Pulse repetition interval (PRI) of signal 1. PRI is measured in time units. PRI is equivalent to $1/PRF$ , where PRF is the pulse repetition frequency.
2	Pulse repetition interval (PRI) of signal 2.
3	Pulse width of signal 1. Pulse width is also referred to as $\tau$ (tau).
4	Pulse width ( $\tau$ ) of signal 2.
5	Signal delay of signal 2. Notice that there is no signal delay for signal 1.
6	Gate trigger input for Option 105. The trigger input coincides with signal 1.

Use the guidelines in Table 2-1 when using Option 105 to view a pulsed RF signal. These are only guidelines, and the analyzer settings can be changed if necessary.

**Table 2-1.  
Determining Spectrum Analyzer Settings for Viewing a Pulsed RF Signal**

Spectrum Analyzer Function	Spectrum Analyzer Setting	Comments
Sweep Time	Set the sweep time to be 401 times greater than the pulse repetition interval (PRI):  Sweep time > 401 × PRI	Because the gate must be on at least once per trace point, the sweep time has to be set to the pulse repetition interval times for every point of the trace. (Each trace has 401 points.)
Gate Delay	The gate delay is equal to the signal delay plus half of the pulse width:  Gate Delay = Signal Delay + $\tau/2$	The gate delay must be set so that the gating captures the pulse. If the gate delay is too short or too long, the gating can miss the pulse or include resolution bandwidth transient responses.
Gate Length	The gate length is equal to one-fourth the pulse width:  Gate Length = $\tau/4$	If the gate length is too long, the signal display can include transients caused by the spectrum analyzer filters.
Video Bandwidth	Set the video bandwidth to a value greater than 1 divided by the gate length:  Video Bandwidth > $\frac{1}{\text{gate length}}$	The video bandwidth must be wide enough so that the rise times of the video bandwidth do not attenuate the signal.
Resolution Bandwidth	Set the resolution bandwidth to a value greater than 2 divided by the gate delay minus the signal delay:  Resolution Bandwidth > $\frac{2}{\text{Gate Delay} - \text{Signal Delay}}$	The resolution bandwidth must be wide enough so that the charging time for the resolution bandwidth filters is less than the pulse width of the signal.

### Example of a Time-Gated Pulsed RF Signal

**Note**  This example only applies to using Option 105 with a pulsed RF signal. For more information on using Option 105 to view other types of signals, see the product note for Option 105.

The following example demonstrates these rules. In this example, we are using two signal generators to generate two signals at the same frequency (50 MHz). The pulse generators “space” (interleave) the signals in time as well as pulse modulate the signals.

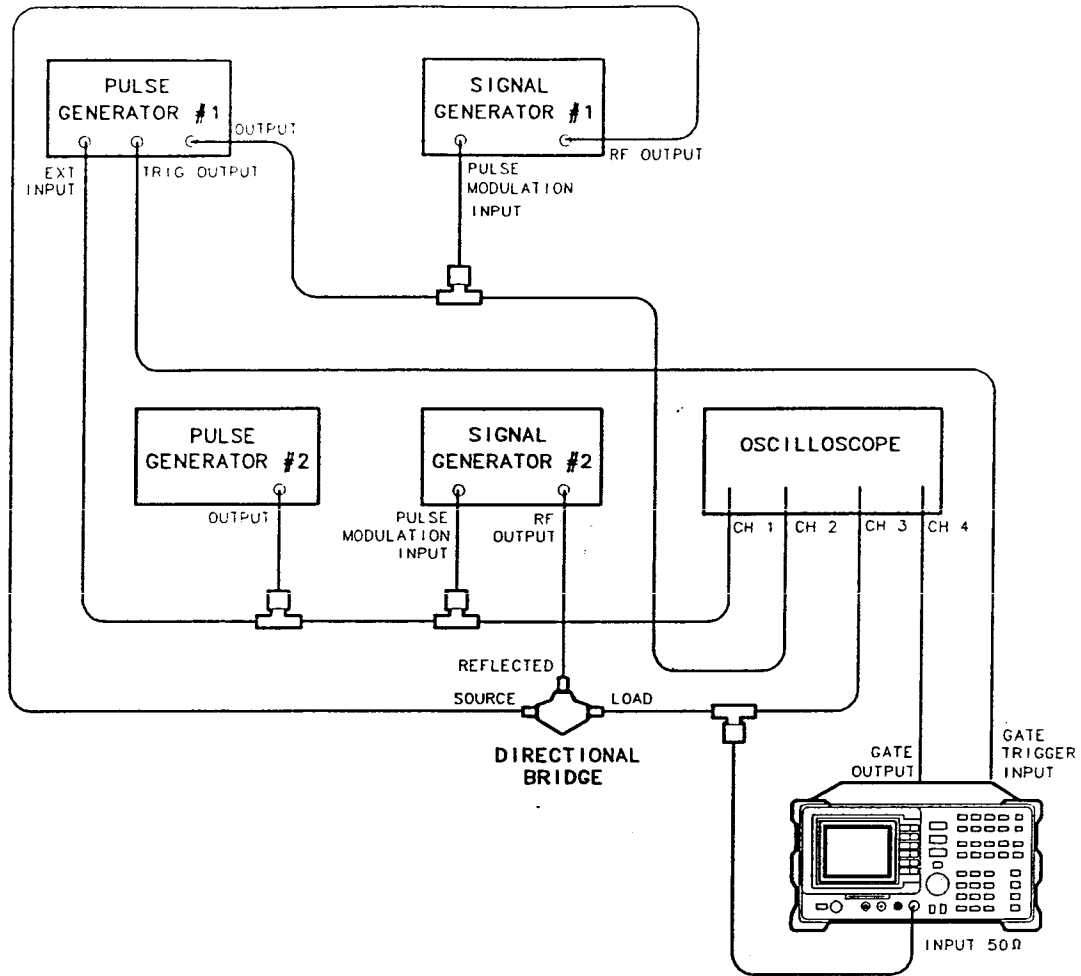

Figure 2-56. Test Setup for Option 105

**Note** Be sure that the input impedance for the oscilloscope channels is set to 1 MΩ.



Table 2-2. Pulse Generator Test Setup Settings

Setting	Pulse Generator #1	Pulse Generator #2
Period	280 $\mu$ s	280 $\mu$ s
Width	50 $\mu$ s	50 $\mu$ s
Trigger	Positive edge of square wave	Not applicable
Voltage (peak to peak)	5 V	5 V
Trigger delay	85 $\mu$ s	None

Table 2-3. Signal Generator Test Setup Settings

Setting	Signal Generator 1	Signal Generator 2
Frequency	50 MHz	50 MHz
Amplitude	-1 dBm	-10 dBm
Pulse Modulation	On	On

1. Set the center frequency of the spectrum analyzer to the frequency of the modulated signal. Decrease the frequency span of the spectrum analyzer. If necessary, adjust the reference level of the spectrum analyzer so that the peak signal is displayed near the top graticule.

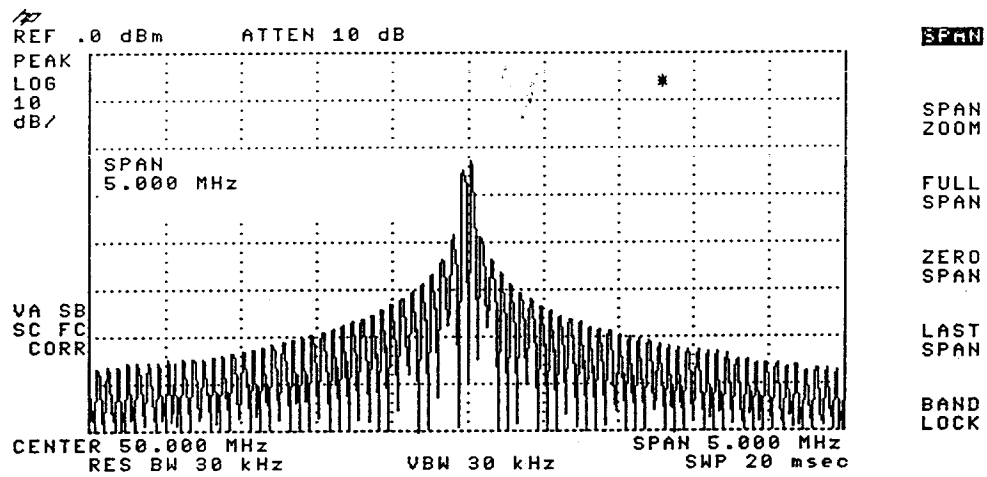

Figure 2-57. Setting the Center Frequency, Span, and Reference Level

2. Set the sweep time to be 401 times greater than the pulse repetition interval. For this example, the pulse repetition interval is  $280 \mu\text{s}$ , so the sweep time is set to greater than 401 times  $280 \mu\text{s}$ , or 0.112 s. For this example, we are using a sweep time of 120 milliseconds. Press **[SWEEP]**, 120 **[ms]**.

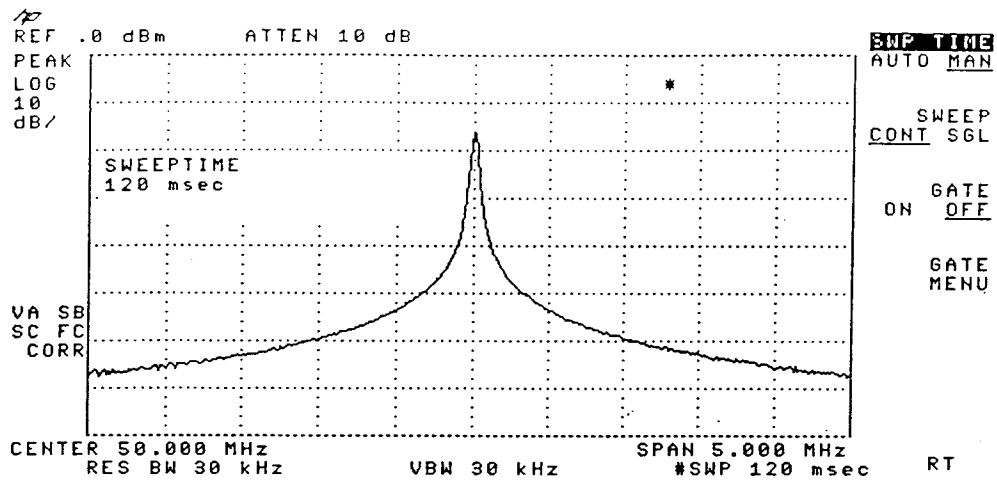

Figure 2-58. Setting the Sweep Time

- Turn the gate on by pressing **[SWEEP]**, GATE ON OFF (so that ON is underlined).

Using an oscilloscope makes it easier to ensure that the gate occurs during the pulsed RF signal. With GATE OUTPUT connected to the oscilloscope, you can adjust the gate length and gate delay so that the gate occurs near the end of the pulse. See Figure 2-59.

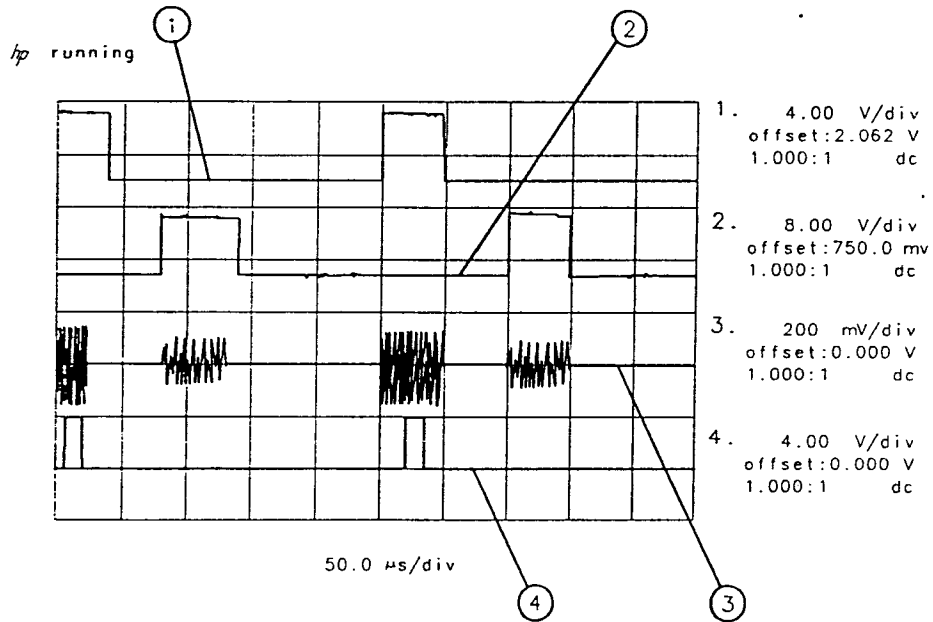

Figure 2-59. Setting the Gate Delay and Gate Length Using an Oscilloscope

Item	Description of Items in Figure 2-59
1	Output from pulse generator 1.
2	Output from pulse generator 2.
3	Pulsed RF signal input to the spectrum analyzer.
4	Gate output from Option 105. Notice that the gate output is directly below signal 1.

If you do not have an oscilloscope, it is very important to use the guidelines for determining gate length and gate delay. See "Setting the Gate Delay and Gate Length Properly" following this section.

- The gate delay must be equal to the signal delay plus the pulse width ( $\tau$ ) divided by 2. For the first signal, there is no signal delay, so the gate delay needs to be set to  $50 \mu\text{s}/2$ , or  $25 \mu\text{s}$ . Press **[SWEEP]**, **GATE MENU**,  $25$  **[ $\mu\text{s}$ ]**.

**Note**

Pressing **GATE MENU** makes the **GATE DELAY** softkey function the active function.



- Set the gate length to a value equal to the pulse width ( $\tau$ ) divided by 4. For this example, the gate length is set to  $50 \mu\text{s}/4$ , or  $13 \mu\text{s}$ . Press **GATE LENGTH**,  $13$  **[ $\mu\text{s}$ ]**.
- Set the resolution bandwidth to a value that is greater than 2 divided by the gate delay minus the signal delay. For this signal 1, there is no signal delay, so the resolution bandwidth is set greater than  $2/25 \mu\text{s}$ , or greater than  $80 \text{ kHz}$ . Press **[BW]**,  $100$  **[kHz]**.
- Set the video bandwidth to a value that is greater than 1 divided by the gate length. For this example, the video bandwidth must be greater than  $1/13 \mu\text{s}$ , or  $80 \text{ kHz}$ . Press **[BW]**, **VID BW AUTO MAN**,  $100$  **[kHz]**.

See Figure 2-60. The analyzer displays only signal 1, not both signal 1 and signal 2.

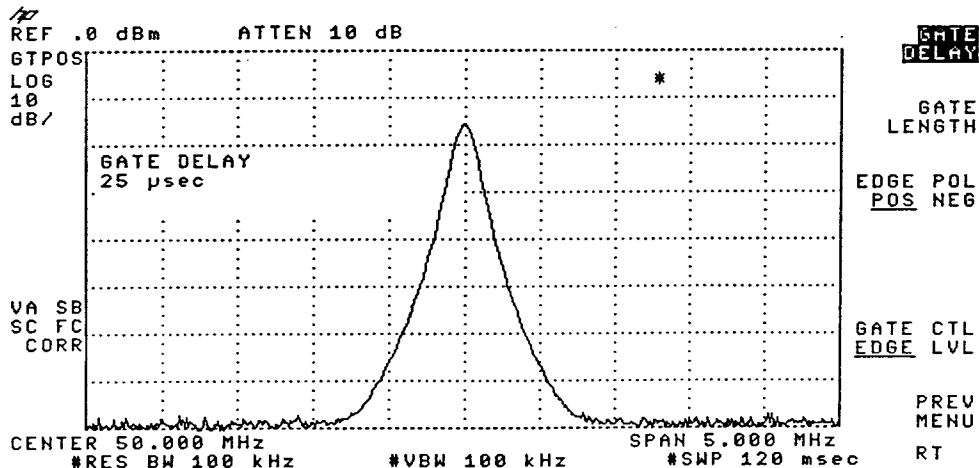

Figure 2-60. Using Time-Gating to View Signal 1

- To compare signal 1 to signal 2, we first place signal 1 (trace A) in the view mode. Press **[TRACE]**, **VIEW A**, **TRACE A B C** (so that B is underlined), **CLEAR WRITE B**.
- To view the second signal, change the gate delay so that the gate output is under the second signal. Since the second signal had a signal delay of approximately  $85 \mu\text{s}$ , we set the gate delay to  $85 \mu\text{s}$  plus the pulse width/2, or  $110 \mu\text{s}$ . Press **[SWEEP]**, **GATE MENU**,  $110$  **[ $\mu\text{s}$ ]** to set the gate delay to  $110 \mu\text{s}$ . Using an oscilloscope can be helpful in placing the gate output during the pulsed signal. See Figure 2-61.

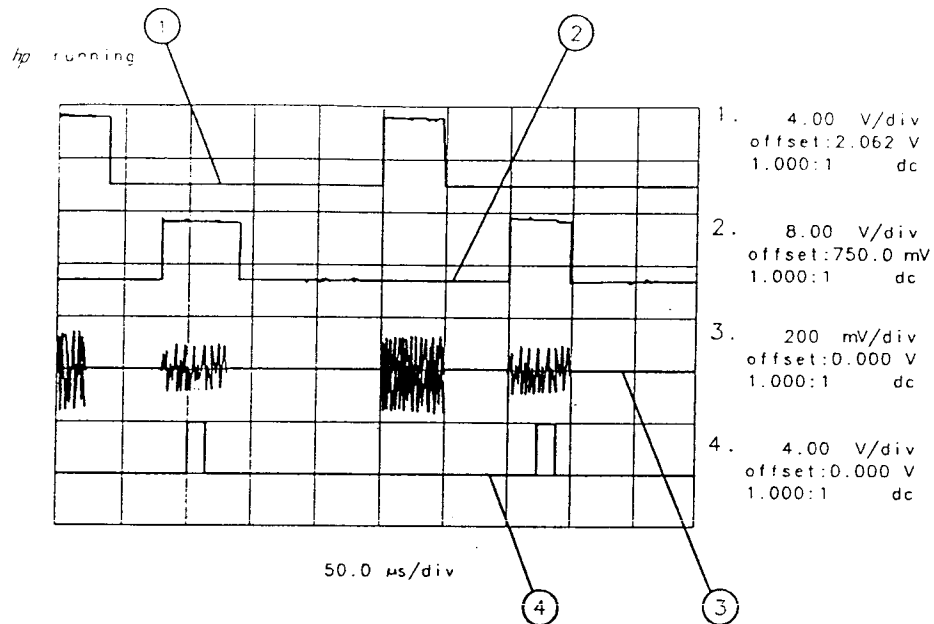

Figure 2-61. Placing the Gate Output During the Second Signal

Item	Description of Items in Figure 2-59
1	Output from pulse generator 1.
2	Output from pulse generator 2.
3	Pulsed RF signal input to the spectrum analyzer.
4	Gate output from Option 105. Notice that the gate output is directly below signal 2.

10. Set the resolution bandwidth to a value that is greater than 2 divided by the gate delay ( $110 \mu\text{s}$ ) minus the signal delay ( $85 \mu\text{s}$ ). The resolution bandwidth should be set to greater than 2 divided by  $25 \mu\text{s}$ , or greater than 80 kHz. Press **BW**, **RES BW**, 100 **kHz**.
11. Since the gate length was not changed, the video bandwidth is still 100 kHz.



Figure 2-62 shows the first pulsed RF signal (contained in trace A), and the second pulsed RF signal (contained in trace B).

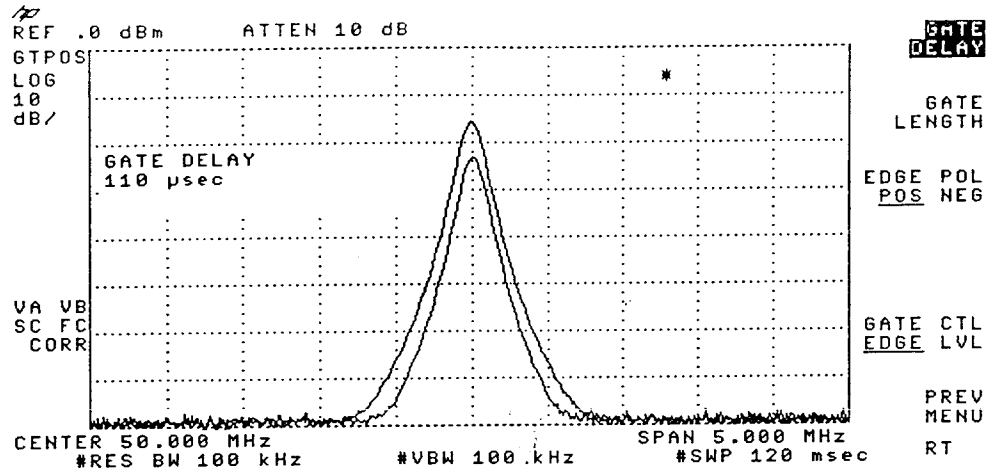

Figure 2-62. Viewing Both Signals with Time-Gating

### Setting the Gate Delay and Gate Length Properly

If the gate delay and gate length are not set properly, you may not be viewing an accurate representation of a signal. For example, If the gate does not occur during the RF pulsed signal, the amplitude of the signal displayed on the spectrum analyzer is lower than the actual signal. See Figure 2-63.

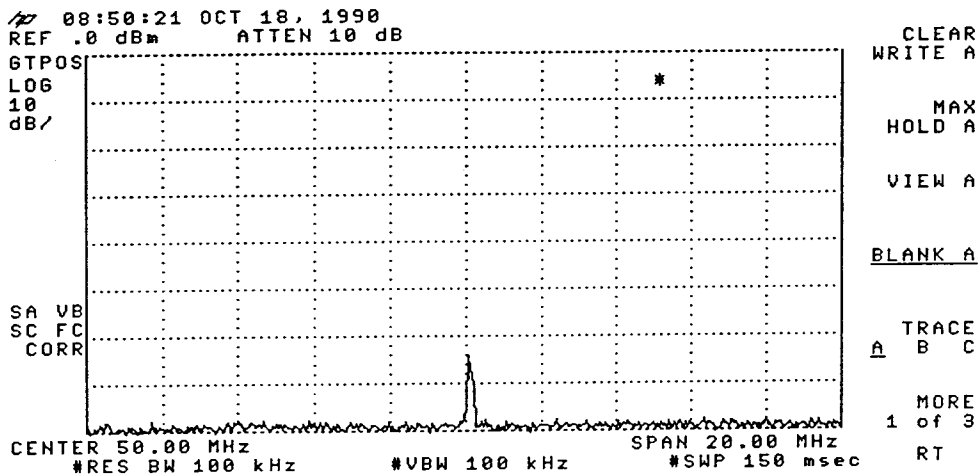

Figure 2-63. Gate Not Occurring During the Pulse

The displayed signal is a result of the decay time for the resolution bandwidth filters of the spectrum analyzer and is not an accurate representation of the input signal.

If the gate occurs at the beginning of the RF pulse signal or at the end of the RF pulse signal, the signal displayed on the spectrum analyzer can be attenuated or contain transient signals caused by the spectrum analyzer (see Figure 2-64). If this happens, decrease the gate length and change the gate delay to place the gate output during the signal.

### 2-64 Analyzer Measurements and Applications

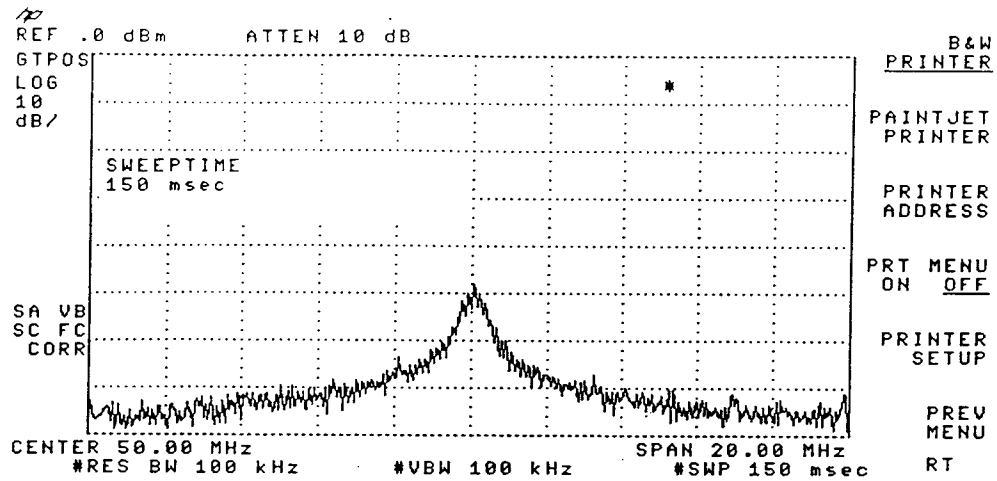

Figure 2-64. Gate is Occurring at the Beginning of the Pulse

In Figure 2-64, the peak amplitude has not been reached, and the transient response of the resolution bandwidth filters adds noise.

Table 2-4 and Table 2-5 provide the recommended initial spectrum analyzer settings when measuring a signal without signal delay.

**Note** Refer to the guidelines in Table 2-1 when measuring a signal with signal delay.



To use Table 2-4 and Table 2-5:

- Determine the pulse width of the signal you want to measure, then use Table 2-4 to determine the gate delay, resolution bandwidth, gate length, and video bandwidth analyzer settings.
- Determine the pulse repetition rate of the signal, then use Table 2-5 to determine the analyzer's sweep time setting.

**Table 2-4.**  
**Gate Delay, Resolution Bandwidth, Gate Length, and Video Bandwidth Settings**

Pulse width ( $\tau$ )	Gate Delay	Resolution Bandwidth	Gate Length	Video Bandwidth
10 $\mu$ s	5 $\mu$ s*	1 MHz	3 $\mu$ s	1 MHz
50 $\mu$ s	25 $\mu$ s	100 kHz	13 $\mu$ s	100 kHz
63.5 $\mu$ s	32 $\mu$ s	100 kHz	16 $\mu$ s	100 kHz
100 $\mu$ s	50 $\mu$ s	100 kHz	25 $\mu$ s	100 kHz
500 $\mu$ s	250 $\mu$ s	10 kHz	125 $\mu$ s	10 kHz
1 ms	500 $\mu$ s	10 kHz	250 $\mu$ s	10 kHz
5 ms	2.5 ms	1 kHz	1.25 ms	1 kHz
10 ms	5 ms	1 kHz	2.5 ms	1 kHz
16.6 ms	8.3 ms	1 kHz	4 ms	1 kHz
33 ms	16.5 ms	1 kHz	8 ms	1 kHz
50 ms	25 ms	1 kHz	13 ms	1 kHz
100 ms	50 ms	1 kHz	25 ms	1 kHz
>130 ms	65 ms	1 kHz	33 ms	1 kHz

\* When using the short gate delays, you may notice the gate delay time jitter by  $\pm 1 \mu$ s. This jitter is due to the analyzer's 1 MHz gate clock, and it does not indicate a problem.

**Table 2-5. Sweep Time Settings**

Pulse Repetition Interval (PRI)	Pulse Repetition Frequency (PRF)	Sweep Time (minimum)
$\leq 50 \mu$ s	$\geq 20$ kHz	21 ms
100 $\mu$ s	10 kHz	41 ms
500 $\mu$ s	2 kHz	201 ms
1 ms	1 kHz	401 ms
5 ms	200 Hz	2.01 s
10 ms	100 Hz	4.01 s
16.7 ms	60 Hz	6.7 s
33.3 ms	30 Hz	13.4 s
50 ms	20 Hz	20.1 s
100 ms	10 Hz	40.1 s
200 ms	5 Hz	80.2 s
249 ms	4 Hz	100 s
>249 ms	Use the MAX HOLD trace function and take several measurement sweeps.	



## Analyzer Functions

---

### What You'll Learn in This Chapter

This chapter describes functions, controls, and connectors of the spectrum analyzer. The front-panel keys and softkey functions are listed alphabetically (except for the service diagnostic functions which are listed after Table 3-1). Use Table 3-1 to find the page number of the function's description. Table 3-1 is categorized to correspond with the functional blocks of the analyzer as follows:

- Amplitude
- Control
- Copy
- Frequency
- Instrument state
- Marker
- Span

---

**Note**

All analyzer key functions are listed alphabetically by functional group in an index at the beginning of this chapter. In addition, all softkeys and their relationship to the front-panel keys are shown in Chapter 4, "Key Menus."

---

Table 3-1. Key Summary by Functional Group

Group	Front-Panel Keys and Softkeys	Option Required	Front-panel key access	Page
AMPLITUDE	AMPLITUDE		AMPLITUDE	3-17
	AMPTD UNITS		AMPLITUDE	3-17
	ATTEN AUTO MAN		AMPLITUDE or AUTO COUPLE	3-18
	COUPLE AC DC		AMPLITUDE	3-34
	dBm		AMPLITUDE	3-35
	dBmV		AMPLITUDE	3-35
	dBuV		AMPLITUDE	3-35
	EXT PREAMP		AMPLITUDE	3-39
	INPUT Z 50 75		AMPLITUDE	3-42
	MAX MXR LEVEL		AMPLITUDE	3-46
	PRESEL DEFAULT		AMPLITUDE	3-50
	PRESEL PEAK		AMPLITUDE	3-50
	REF LVL		AMPLITUDE	3-56
	REF LVL OFFSET		AMPLITUDE	3-57
	SCALE LOG LIN		AMPLITUDE	3-58
	Volts		AMPLITUDE	3-68
	Watts		AMPLITUDE	3-68
CONTROL	9 kHz EMI BW		BW	3-15
	120 kHz EMI BW		BW	3-16
	A <--> B		TRACE	3-16
	A-B -> A ON OFF		TRACE	3-16
	A -> C		TRACE	3-16
	ABCDEF		CONFIG, DISPLAY, or MEAS/USER	3-16
	ANNOTATN ON OFF		DISPLAY	3-17
	ATTEN AUTO MAN		AMPLITUDE or AUTO COUPLE	3-18
	AUTO ALL		AUTO COUPLE	3-18
	AUTO COUPLE			3-18
	B -> C		TRACE	3-19
	B <--> C		TRACE	3-19
	B-DL -> B		TRACE	3-19
	BLANK A		TRACE	3-20
	BLANK B		TRACE	3-20
	BLANK C		TRACE	3-20
	BW			3-21

3-2 Analyzer Functions

Table 3-1. Key Summary by Functional Group (continued)

Group	Front-Panel Keys and Softkeys	Option Required	Front-panel key access	Page
CONTROL	CF STEP AUTO MAN		(AUTO COUPLE) or (FREQUENCY)	3-28
	CHANGE PREFIX		(CONFIG) or (DISPLAY)	3-28
	CHANGE TITLE		(DISPLAY) or (MEAS/USER)	3-28
	CLEAR		(CONFIG), (DISPLAY), or (MEAS/USER)	3-29
	CLEAR WRITE A		(TRACE)	3-29
	CLEAR WRITE B		(TRACE)	3-30
	CLEAR WRITE C		(TRACE)	3-30
	DETECTOR SAMPL PK		(TRACE)	3-36
	(DISPLAY)			3-37
	DSP LINE ON OFF		(DISPLAY)	3-37
	EDGE POL POS NEG	105	(SWEEP)	3-38
	EXTERNAL		(TRIG)	3-39
	FREE RUN		(TRIG)	3-40
	GATE CTL EDGE LVL	105	(SWEEP)	3-41
	GATE DELAY	105	(SWEEP)	3-42
	GATE LENGTH	105	(SWEEP)	3-42
	GATE MENU	105	(SWEEP)	3-42
	GATE ON OFF	105	(SWEEP)	3-42
	GHIJKL		(CONFIG), (DISPLAY), or (MEAS/USER)	3-42
	GRAT ON OFF		(DISPLAY)	3-42
	LINE		(TRIG)	3-43
	MAX HOLD A		(TRACE)	3-45
	MAX HOLD B		(TRACE)	3-45
	MIN HOLD C		(TRACE)	3-46
	MNOPQR		(CONFIG), (DISPLAY), or (MEAS/USER)	3-47
	NORMLIZE ON OFF		(TRACE)	3-47
	NORMLIZE POSITION		(TRACE)	3-47
	NTSC	101 and 102	(TRIG)	3-48
	PAL	101 and 102	(TRIG)	3-48
	PAL-M	101 and 102	(TRIG)	3-48
	RES BW AUTO MAN		(AUTO COUPLE) or (BW)	3-57
	RPG TITLE		(DISPLAY) or (MEAS/USER)	3-57
	SECAM-L	101 and 102	(TRIG)	3-59
STUVWX		(CONFIG), (DISPLAY), or (MEAS/USER)	3-63	

Table 3-1. Key Summary by Functional Group (continued)

Group	Front-Panel Keys and Softkeys	Option Required	Front-panel key access	Page
CONTROL	(SWEEP)			3-63
	SWEEP CONT SGL		(SWEEP) or (TRIG)	3-63
	SWP TIME AUTO MAN		(AUTO COUPLE) or (SWEEP)	3-63
	THRESHLD ON OFF		(DISPLAY)	3-64
	(TRACE)			3-64
	TRACE A B C		(TRACE)	3-64
	(TRIG)			3-66
	TV LINE #	101 and 102	(TRIG)	3-66
	TVSTND	101 and 102	(TRIG)	3-66
	TV SYNC NEG POS	101 and 102	(TRIG)	3-66
	TV TRIG	101 and 102	(TRIG)	3-66
	TV TRIG EVEN FLD	101 and 102	(TRIG)	3-66
	TV TRIG ODD FLD	101 and 102	(TRIG)	3-66
	TV TRIG VERT INT	101 and 102	(TRIG)	3-66
	VBW/RBW RATIO		(BW)	3-67
	VID AVG ON OFF		(BW) or (TRACE)	3-67
	VID BW AUTO MAN		(AUTO COUPLE) or (BW)	3-67
	VIDEO		(TRIG)	3-67
	VIEW A		(TRACE)	3-67
	VIEW B		(TRACE)	3-68
VIEW C		(TRACE)	3-68	
YZ_# SPC CLEAR		(CONFIG), (DISPLAY), or (MEAS/USER)	3-68	
COPY	(COPY)	021 or 023		3-32
FREQUENCY	CENTER FREQ		(CONFIG) or (FREQUENCY)	3-28
	CF STEP AUTO MAN		(FREQUENCY)	3-28
	FREQ OFFSET		(FREQUENCY)	3-41
	(FREQUENCY)			3-41
	START FREQ		(FREQUENCY)	3-62
	STOP FREQ		(FREQUENCY)	3-63

3-4 Analyzer Functions



Table 3-1. Key Summary by Functional Group (continued)

Group	Front-Panel Keys and Softkeys	Option Required	Front-panel key access	Page
INSTRUMENT STATE	% AM		MEAS/USER	3-15
	+10V REF DETECTOR		CAL	3-15
	-10V REF DETECTOR		CAL	3-15
	2v REF DETECTOR		CAL	3-15
	3 dB POINTS		MEAS/USER	3-15
	3rd ORD MEAS		MEAS/USER	3-15
	6 dB POINTS		MEAS/USER	3-15
	99% PWR BW		MEAS/USER	3-16
	ABCDEF		CONFIG, DISPLAY, MEAS/USER, RECALL, or SAVE	3-16
	ABORT		AUX CTRL	3-16
	ACCEPT QP DATA	103	AUX CTRL	3-16
	ALC INT EXT			3-16
	ALC MTR INT XTAL		AUX CTRL	3-17
	ALC TEST	010 or 011	CAL	3-17
	ALL DLP ->CARD		SAVE	3-17
	AMP COR		MEAS/USER, RECALL, or SAVE	3-17
	AMP COR ON OFF		MEAS/USER	3-17
	ANALYZER ADDRESS	021	CONFIG	3-17
	AUTO QP AT MKR	103	AUX CTRL	3-18
	AUXA		CAL	3-19
	AUXB		CAL	3-19
	AUX CONN CONTROL		AUX CTRL	3-19
	AUX CTRL			3-19
	B & W PRINTER	021 or 023	CONFIG	3-19
	BAUD RATE	023	CONFIG	3-20
	BINARY SPAN		CAL	3-20
	BLANK CARD		CONFIG	3-20
	CAL			3-21
	CAL AMPTD		CAL	3-21

Table 3-1. Key Summary by Functional Group (continued)

Group	Front-Panel Keys and Softkeys	Option Required	Front-panel key access	Page
INSTRUMENT STATE	CAL FETCH		(CAL)	3-21
	CAL FREQ		(CAL)	3-21
	CAL FREQ & AMPTD		(CAL)	3-21
	CAL MXR		(CAL)	3-21
	CAL STORE		(CAL)	3-21
	CAL TIMEBASE		(CAL)	3-21
	CAL TRK GEN	010 or 011	(CAL)	3-21
	CAL YTF		(CAL)	3-22
	CARD CONFIG		(CONFIG)	3-22
	CARD ->DLP		(RECALL)	3-22
	CARD ->STATE		(RECALL)	3-22
	CARD ->TRACE		(RECALL)	3-22
	CATALOG ALL		(RECALL) or (SAVE)	3-22
	CATALOG AMP COR		(RECALL) or (SAVE)	3-22
	CATALOG CARD		(CONFIG), (RECALL) or (SAVE)	3-23
	CATALOG DLP		(RECALL) or (SAVE)	3-24
	CATALOG INTRNL		(RECALL) or (SAVE)	3-24
	CATALOG LMT LINE		(RECALL) or (SAVE)	3-26
	CATALOG ON EVENT		(RECALL) or (SAVE)	3-26
	CATALOG PREFIX		(RECALL) or (SAVE)	3-27
	CATALOG REGISTER		(RECALL) or (SAVE)	3-27
	CATALOG STATES		(RECALL) or (SAVE)	3-27
	CATALOG TRACES		(RECALL) or (SAVE)	3-27
	CATALOG VARIABLES		(RECALL) or (SAVE)	3-27
	CENTER FREQ	103	(AUX CTRL)	3-28
	CHANGE PREFIX		(CONFIG), (DISPLAY), (RECALL), or (SAVE)	3-28
	CHANGE TITLE		(MEAS/USER)	3-28
	CLEAR		(CONFIG), (DISPLAY), (RECALL), or (SAVE)	3-29
	CLEAR OFFSET		(AUX CTRL)	3-29
	CLEAR QP DATA	103	(AUX CTRL)	3-29
	CNTL A 0 1		(AUX CTRL)	3-31
	CNTL B 0 1		(AUX CTRL)	3-31
	CNTL C 0 1		(AUX CTRL)	3-31
	CNTL D 0 1		(AUX CTRL)	3-31

3-6 Analyzer Functions

Table 3-1. Key Summary by Functional Group (continued)

Group	Front-Panel Keys and Softkeys	Option Required	Front-panel key access	Page
INSTRUMENT STATE	COARSE TUNE DAC		<b>CAL</b>	3-31
	COMB GEN ON OFF		<b>AUX CTRL</b>	3-31
	<b>CONFIG</b>			3-31
	CONF TEST		<b>CAL</b>	3-32
	CONTINUE		<b>AUX CTRL</b>	3-32
	COPY DEV PRNT PLT	021 or 023	<b>CONFIG</b>	3-34
	CORRECT ON OFF		<b>CAL</b>	3-34
	CORRECT TO COMB		<b>AUX CTRL</b>	3-34
	CRT HORZ POSITION		<b>CAL</b>	3-34
	CRT VERT POSITION		<b>CAL</b>	3-34
	DACS		<b>CAL</b>	3-34
	DATEMODE MDY DMY		<b>CONFIG</b>	3-35
	DEFAULT CAL DATA		<b>CAL</b>	3-35
	DEFAULT CONFIG		<b>CONFIG</b>	3-35
	DELETE FILE		<b>SAVE</b> or <b>RECALL</b>	3-35
	DELETE POINT		<b>MEAS/USER</b>	3-36
	DELETE SEGMENT		<b>MEAS/USER</b>	3-36
	DELTA MEAS		<b>MEAS/USER</b>	3-36
	DEMODO	102 or 103	<b>AUX CTRL</b>	3-36
	DEMODO AM FM	102 or 103	<b>AUX CTRL</b>	3-36
	DEMODO ON OFF	102 or 103	<b>AUX CTRL</b>	3-36
	DISPLAY CAL DATA		<b>CAL</b>	3-37
	DISPLAY CNTL I		<b>AUX CTRL</b>	3-37
	DISPOSE USER MEM		<b>CONFIG</b>	3-37
	DROOP		<b>CAL</b>	3-37
	DWELL TIME	102 or 103	<b>AUX CTRL</b>	3-37
	EDIT AMP COR		<b>MEAS/USER</b>	3-38
	EDIT DONE		<b>CONFIG</b> , <b>MEAS/USER</b> , <b>RECALL</b> , or <b>SAVE</b>	3-38
	EDIT FLATNESS		<b>CAL</b>	3-38
	EDIT LIMIT		<b>MEAS/USER</b>	3-38
	EDIT LOWER		<b>MEAS/USER</b>	3-38
	EDIT MID/DELT		<b>MEAS/USER</b>	3-38

Table 3-1. Key Summary by Functional Group (continued)

Group	Front-Panel Keys and Softkeys	Option Required	Front-panel key access	Page
INSTRUMENT STATE	EDIT UP/LOW		MEAS/USER	3-39
	EDIT UPPER		MEAS/USER	3-39
	EDIT UPR LWR		MEAS/USER	3-39
	EXECUTE TITLE		CAL	3-39
	EXIT		CAL	3-39
	EXIT CATALOG		RECALL or SAVE	3-39
	EXIT SHOW		CONFIG	3-39
	FFT MEAS		MEAS/USER	3-40
	FINE TUNE DAC		CAL	3-40
	FLAT		MEAS/USER	3-40
	FLATNESS DATA		CAL	3-40
	FM COIL DRIVE		CAL	3-40
	FM GAIN	102 or 103	AUX CTRL or CAL	3-40
	FM OFFSET	102 or 103	CAL	3-40
	FM SPAN		CAL	3-40
	FORMAT CARD		CONFIG	3-40
	FREQ DIAG		CAL	3-40
	FREQ DISC NORM OFF		CAL	3-40
	GHIJKL		CONFIG, DISPLAY, MEAS/USER, RECALL, or SAVE	3-42
	GND REF DETECTOR		CAL	3-42
	INTRNL CRD		RECALL or SAVE	3-42
	INTRNL ->STATE		RECALL	3-42
	INTRNL ->TRACE		RECALL	3-42
	LIMIT LINES		MEAS/USER, RECALL, or SAVE	3-43
	LIMITS FIX REL		MEAS/USER	3-43
	LIMITEST ON OFF		MEAS/USER	3-43
	LOAD FILE		SAVE or RECALL	3-43
	(LOCAL)		CONFIG	3-44
	MAIN COIL DR		CAL	3-44
	MAIN SPAN		CAL	3-44
	MAN QP AT MKR	103	AUX CTRL	3-44
	MAN TRK ADJUST	010 or 011	AUX CTRL	3-44
	MARKER NORM PK	103	AUX CTRL	3-45
			MEAS/USER	3-46

3-8 Analyzer Functions

Table 3-1. Key Summary by Functional Group (continued)

Group	Front-Panel Keys and Softkeys	Option Required	Front-panel key access	Page
INSTRUMENT STATE	MIXER BIAS DAC		<b>CAL</b>	3-46
	MNOPQR		<b>CONFIG</b> , <b>DISPLAY</b> , <b>MEAS/USER</b> , <b>RECALL</b> , or <b>SAVE</b>	3-47
	<b>MODE</b>			3-47
	NEW LIMIT		<b>MEAS/USER</b>	3-47
	NEXT PK LEFT		<b>AUX CTRL</b>	3-47
	NEXT PK RIGHT		<b>AUX CTRL</b>	3-47
	NO USER MENU(S)		<b>MEAS/USER</b>	3-48
	PAINTJET PRINTER	021 or 023	<b>CONFIG</b>	3-48
	PEAK SEARCH		<b>AUX CTRL</b>	3-49
	PK-PK MEAS		<b>MEAS/USER</b>	3-49
	PLOT CONFIG	021 or 023	<b>CONFIG</b>	3-49
	PLOTTER ADDRESS	021 or 023	<b>CONFIG</b>	3-49
	PLT _ _ LOC _ _	021 or 023	<b>CONFIG</b>	3-49
	PLTS/PG 1 2 4	021 or 023	<b>CONFIG</b>	3-49
	POINT		<b>MEAS/USER</b>	3-49
	POWER ON IP LAST		<b>CONFIG</b>	3-49
	PRESEL DAC		<b>CAL</b>	3-50
	<b>PRESET</b>			3-50
	PRESET SPECTRUM		<b>MODE</b> or <b>PRESET</b>	3-52
	PRINT CONFIG	021 or 023	<b>CONFIG</b>	3-54
	PRINTER ADDRESS	021 or 023	<b>CONFIG</b>	3-54
	PRINTER SETUP	021 or 023	<b>CONFIG</b>	3-54
	PRT MENU ON OFF	021 or 023	<b>CONFIG</b>	3-54
	PURGE AMP COR		<b>MEAS/USER</b>	3-54
	PURGE LIMITS		<b>MEAS/USER</b>	3-54
	PWR SWP ON OFF	010 or 011	<b>AUX CTRL</b>	3-55
	QP X10 ON OFF	103	<b>AUX CTRL</b>	3-55
	QP DET ON OFF	103	<b>AUX CTRL</b> or <b>CAL</b>	3-55
	QP GAIN ON OFF	103	<b>CAL</b>	3-55
	QPD OFFSET	103	<b>CAL</b>	3-55
	QPD RST ON OFF	103	<b>CAL</b>	3-55
	QUASI PEAK	103	<b>AUX CTRL</b>	3-56

Table 3-1. Key Summary by Functional Group (continued)

Group	Front-Panel Keys and Softkeys	Option Required	Front-panel key access	Page
INSTRUMENT STATE	RECALL			3-56
	RECALL AMP COR		MEAS/USER	3-56
	RECALL LIMIT		MEAS/USER	3-56
	RETURN	103	AUX CTRL	3-57
	RPG TITLE		DISPLAY or MEAS/USER	3-57
	SAVE			3-57
	SAVE AMP COR		MEAS/USER	3-58
	SAVE LIMIT		MEAS/USER	3-58
	SAV LOCK ON OFF		SAVE	3-58
	SELECT AMPLITUD		MEAS/USER	3-59
	SELECT DLT AMPL		MEAS/USER	3-59
	SELECT FREQ		MEAS/USER	3-59
	SELECT LWR AMPL		MEAS/USER	3-59
	SELECT MID AMPL		MEAS/USER	3-59
	SELECT POINT		MEAS/USER	3-60
	SELECT PREFX		RECALL or SAVE	3-60
	SELECT SEGMENT		MEAS/USER	3-60
	SELECT TYPE		MEAS/USER	3-60
	SELECT UPR AMPL		MEAS/USER	3-60
	SERVICE CAL		CAL	3-60
	SERVICE DIAG		CAL	3-60
	SET ATTN ERROR		CAL	3-60
	SET DATE		CONFIG	3-60
	SET TIME		CONFIG	3-60
	SETPLL OUTDAC		CAL	3-61
	SGL SWP			3-61
	SHOW OPTIONS		CONFIG	3-61
	SLOPE		MEAS/USER	3-61
	SPEAKER ON OFF	102 or 103	AUX CTRL	3-61
	SPECTRUM ANALYZER		PRESET	3-61
	SQUELCH	102 or 103	AUX CTRL	3-62
	SRC ATN MAN AUTO	010 or 011	AUX CTRL	3-62
	SRC PWR OFFSET	010 or 011	AUX CTRL	3-62
	SRC PWR ON OFF	010 or 011	AUX CTRL	3-62

Table 3-1. Key Summary by Functional Group (continued)

Group	Front-Panel Keys and Softkeys	Option Required	Front-panel key access	Page
INSTRUMENT STATE	SRC PWR STP SIZE	010 or 011	(AUX CTRL)	3-62
	STATE ->CARD		(SAVE)	3-62
	STATE ->INTRNL		(SAVE)	3-62
	STP GAIN ZERO		(CAL)	3-63
	STUVWX		(CONFIG), (DISPLAY), (MEAS/USER), (RECALL), or (SAVE)	3-63
	SWEEP RAMP		(CAL)	3-63
	SWEEP TIME DAC		(CAL)	3-63
	SWP CPLG SR SA	010 or 011	(AUX CTRL)	3-63
	TIMEDATE		(CONFIG)	3-64
	TIMEDATE ON OFF		(CONFIG)	3-64
	TRACE A		(RECALL) or (SAVE)	3-64
	TRACE B		(RECALL) or (SAVE)	3-64
	TRACE C		(RECALL) or (SAVE)	3-64
	TRACE ->CARD		(SAVE)	3-64
	TRACE ->INTRNL		(SAVE)	3-65
	TRACK GEN	010 or 011	(AUX CTRL)	3-65
	TRACKING PEAK	010 or 011	(AUX CTRL)	3-65
	USER MENU(S)		(MEAS/USER)	3-66
	VERIFY TIMEBASE		(CAL)	3-67
	X FINE TUNE DAC		(CAL)	3-68
	YTF DRIVER		(CAL)	3-68
	YTF TUNE COARSE		(CAL)	3-68
	YTF TUNE FINE		(CAL)	3-68
	YZ_# SPC CLEAR		(CONFIG), (DISPLAY), (MEAS/USER), (RECALL), or (SAVE)	3-68

Table 3-1. Key Summary by Functional Group (continued)

Group	Front-Panel Keys and Softkeys	Option Required	Front-panel key access	Page
MARKER	CNT RES AUTO MAN		(MKR)	3-31
	MARKER AMPTD		(MKR)	3-44
	MARKER ->CF		(MKR ->) or (PEAK SEARCH)	3-45
	MARKER ->CF STEP		(MKR ->)	3-45
	MARKER DELTA		(MKR) or (PEAK SEARCH)	3-45
	MARKER NORMAL		(MKR)	3-45
	MARKER ->REF LVL		(MKR ->)	3-45
	MARKERS OFF		(MKR)	3-45
	MINIMUM ->MARKER		(MKR ->)	3-46
	MKNOISE ON OFF		(MKR)	3-46
	MKPAUSE ON OFF		(MKR)	3-46
		(MKR)		3-46
		(MKR ->)		3-46
	MKR CNT ON OFF		(MKR)	3-46
	MKR Δ ->SPAN		(MKR ->)	3-47
	NEXT PEAK		(MKR ->) or (PEAK SEARCH)	3-47
	NEXT PK LEFT		(MKR ->) or (PEAK SEARCH)	3-47
	NEXT PK RIGHT		(MKR ->) or (PEAK SEARCH)	3-47
	PEAK EXCURSN		(MKR ->) or (PEAK SEARCH)	3-48
	PEAK MENU		(MKR ->)	3-49
		(PEAK SEARCH)		3-49
	PK-PK MEAS		(MKR)	3-49
		(SIGNAL TRACK)		3-61
SPAN	0-2.9 Gz BAND 0		(SPAN)	3-15
	2.75-6.4 BAND 1		(SPAN)	3-15
	6.0-12.8 BAND 2		(SPAN)	3-15
	12.4-19. BAND 3		(SPAN)	3-16
	19.1-22 BAND 4		(SPAN)	3-16
	BAND LOCK		(SPAN)	3-19
	BND LOCK ON OFF		(SPAN)	3-20
	FULL SPAN		(SPAN)	3-41
	LAST SPAN		(SPAN)	3-43
	SPAN		(SPAN)	3-61
		(SPAN)		3-61
	SPAN ZOOM		(SPAN)	3-61
ZERO SPAN		(SPAN)	3-68	

3-12 Analyzer Functions



---

## Service Functions

Two types of functions are available for service use only:

- Service calibration functions.
- Service diagnostic functions.

These service functions are designed for service use only. However, brief descriptions for each function are provided in this chapter. For more detailed descriptions and information about the use of each function, refer to the Installation and Verification Manual for your instrument.

Service documentation can be obtained by ordering Option 915 through your HP Sales and Service office. Option 915 is described in more detail under “Options and Accessories Available” in Chapter 1 of the Installation and Verification Manual for your instrument.

### Service Calibration Functions

SERVICE CAL accesses the following service calibration softkeys:

CAL MXR (HP 8592B, HP 8593A, or HP 8595A only)

CAL TIMEBASE

EDIT FLATNESS

EXECUTE TITLE

FLATNESS DATA

SET ATTN ERROR

### Service Diagnostic Functions

SERVICE DIAG accesses the following service diagnostic softkeys:

+10V REF DETECTOR

-10V REF DETECTOR

2v REF DETECTOR

ALC TEST (HP 8590B or HP 8591A with Option 010 or 011 only)

AUXA

AUXB (HP 8590B or HP 8591A only)

BINARY SPAN (HP 8592B, HP 8593A, or HP 8595A only)

COARSE TUNE DAC

DACS

DISPLAY CAL DATA

DROOP

FINE TUNE DAC

FM COIL DRIVE

FM GAIN (Option 102 or 103 in an HP 8591A, HP 8593A, HP 8594A, or HP 8595A only)

FM OFFST (Option 102 or 103 in an HP 8591A, HP 8593A, HP 8594A, or HP 8595A only)

FM SPAN

FREQ DIAG (HP 8591A, HP 8593A, HP 8594A, or HP 8595A only)

FREQ DISC NORM OFF (HP 8591A, HP 8593A, HP 8594A, or HP 8595A only)

GND REF DETECTOR

MAIN COIL DR

MAIN SPAN

MIXER BIAS DAC (HP 8592B, HP 8593A, or HP 8595A only)

PRESEL DAC (HP 8592B, HP 8593A, or HP 8595A only)

QP DET ON OFF (Option 103 only)

QP GAIN ON OFF (Option 103 only)

QPD RST ON OFF (Option 103 only)

QPD OFFSET (Option 103 only)

SETPLL OUTDAC (HP 8591A, HP 8593A, HP 8594A, or HP 8595A only)

STP GAIN ZERO

SWEEP RAMP

SWEEP TIME DAC

YTF DRIVER (HP 8592B, HP 8593A, or HP 8595A only)

YTF TUNE COARSE (HP 8592B, HP 8593A, or HP 8595A only)

YTF TUNE FINE (HP 8592B, HP 8593A, or HP 8595A only)

X FINE TUNE DAC

## Analyzer Functions

<b>% AM</b>	determines the percent of amplitude modulation of a signal that has amplitude modulation only. Pressing <b>% AM</b> finds the amplitude difference between the two highest peaks on the screen and computes the percent modulation for the calculated dB difference.
<b>+10V REF DETECTOR</b>	displays the output of the +10 V reference from the A7 Analog Interface assembly as a horizontal line at the top graticule. This is a service diagnostic function and is for service use only.
<b>-10V REF DETECTOR</b>	displays the output of the -10 V reference from the A7 Analog Interface assembly as a horizontal line at the bottom graticule. This is a service diagnostic function and is for service use only.
<b>0-2.9 Gz BAND 0</b>	<i>HP 8592B, HP 8593A, and HP 8595A only.</i> locks onto harmonic band 0. Harmonic band 0 uses low-pass filtering instead of bandpass preselection. It has a specified tuning range of 0 to 2.9 GHz.
<b>2v REF DETECTOR</b>	displays the output of the 2 V reference produced on the A16 Processor/Video assembly as a horizontal line at the top graticule. This is a service diagnostic function and is for service use only.
<b>2.75-6.4 BAND 1</b>	<i>HP 8592B and HP 8593A only.</i> locks onto harmonic band 1. Harmonic band 1 is preselected and has a specified tuning range of 2.75 to 6.4 GHz.
<b>2.75-6.5 BAND 1</b>	<i>HP 8595A only.</i> locks onto harmonic band 1. Harmonic band 1 is preselected and has a specified tuning range of 2.75 GHz to 6.5 GHz. The frequency span of band 1 is extended to 6.5 GHz for the HP 8595A.
<b>3 dB POINTS</b>	automatically places two markers at points 3 dB from the highest point on the highest on-screen signal, and determines the frequency differences between the two markers. Thus, the 3 dB bandwidth of a signal is determined. The amplitude scale must be logarithmic.
<b>3rd ORD MEAS</b>	finds the third-order product and measures the frequency and amplitude differences relative to the fundamental signal. Three signals must be on screen. Pressing <b>3rd ORD MEAS</b> performs the routine similar to pressing the following keys: <b>PEAK SEARCH</b> , <b>MARKER DELTA</b> , <b>NEXT PEAK</b> , <b>NEXT PEAK</b> .
<b>6.0-12.8 BAND 2</b>	<i>HP 8592B and HP 8593A only.</i> locks onto harmonic band 2. Harmonic band 2 is preselected and has a specified tuning range of 6.0 to 12.8 GHz.
<b>6 dB POINTS</b>	automatically places two markers at points 6 dB from the highest point on the highest on-screen signal and determines the frequency differences between the two markers. Thus, the 6 dB bandwidth of a signal is determined. The amplitude scale must be logarithmic.
<b>9 kHz EMI BW</b>	allows a 6 dB resolution bandwidth of 9 kHz. This bandwidth is useful when performing electromagnetic interference (EMI) measurements.

12.4-19. BAND 3	<i>HP 8592B and HP 8593A only.</i> locks onto harmonic band 3. Harmonic band 3 is preselected and has a specified tuning range of 12.4 to 19.4 GHz.
19.1-22 BAND 4	<i>HP 8592B and HP 8593A only.</i> locks onto harmonic band 4. Harmonic band 4 is preselected and has a specified tuning range of 19.1 to 22 GHz.
99% PWR BW	computes the power of all signal responses and returns the number representing the bandwidth under which 99% of total power is found.
120 kHz EMI BW	allows a 6 dB resolution bandwidth of 120 kHz. This bandwidth is useful when performing electromagnetic interference (EMI) measurements.
A<-->B	exchanges the contents of the trace A register with the trace B register and puts trace A in view mode.
A-B -> A ON OFF	when ON is underlined, subtracts the data in trace B from the measured data in trace A. A minus sign (-) appears between the trace A status and the trace B status in the screen annotation while the function is active.  To deactivate this function, press <u>A - B -&gt; A ON OFF</u> so that OFF is underlined.  The A-B -> A and B-DL -> B functions are math functions. Unlike operations on dBm units, math functions operate on measurement units. Measurement units are used to format trace data for data within the graticule limits. The displayed amplitude of each element falls on one of 8000 vertical points with the value of 8000 being equal to the reference level. For log scale data, each point is equal to 0.01 dB. The peak of a signal equal to -10 dBm, or one division below the reference level, is equal to 7000 measurement units (8000 - 1000 = 7000). In linear mode, each point has a resolution of [reference level in volts/8000].  For example, if trace A contains amplitude values of -10 dBm and trace B contains amplitude values of -40 dBm, the result of the A - B -> A function would be -10.004 dBm if dBm units were used. Since measurement units are used for the A - B -> A function, the result of A - B -> A is -50 dBm (-10 dBm = 7000 measurement units, -40 dBm = 4000 measurement units; the result is 3000 measurement units, which is equal to -50 dBm).
A -> C	moves trace A into trace C.
ABCDEF	accesses the softkey menu for selecting screen title characters A through F.
ABORT	<i>HP 8592B only.</i> allows you to exit the correct-to-comb routine if you do not wish to add an offset frequency. Pressing ABORT returns you to the auxiliary control softkey menu.
ACCEPT QP DATA	<i>For Option 103 only.</i> displays the quasi-peak amplitude value of the marker. See the HP 8591A or HP 8593A Option 103 Manual Supplement for more information.
ALC INT EXT	<i>HP 8593A, HP 8594A, or HP 8595A with Option 010 only.</i> activates internal (INT) leveling or external (EXT) leveling.

### 3-16 Analyzer Functions

ALC MTR INT XTAL	<i>HP 8590B or HP 8591A with Option 010 or 011 only.</i> is the automatic leveling control (ALC) function that activates internal (INT) leveling or external (XTAL or MTR) leveling. The external leveling input (located on the rear panel of the analyzer) can be used with a power meter or crystal that has a positive or negative voltage output. See Table 1-2 for the leveling input characteristics. External leveling increases the amplitude accuracy by improving the effective source match. The meter (MTR) position narrows ALC loop bandwidth so an HP power meter can be used.
ALC TEST	<i>HP 8590B or HP 8591A with Option 010 or 011 only</i> breaks the leveling loop of the automatic leveling control in the tracking generator. This is a service diagnostic function and is for service use only.
ALL DLP ->CARD	<i>Requires Option 003 for an HP 8590B or HP 8592B.</i> saves all the downloadable programs and key definitions that are in analyzer memory onto the memory card. If the downloadable program was stored using a prefix, the file name for the downloadable program consists of d(prefix)_(register number). If no prefix was specified, the data is stored with the file name d_(register number).
AMP COR	When accessed by <b>MEAS/USER</b> , <b>AMP COR</b> accesses the menus for controlling the current amplitude-correction factors. When accessed by <b>SAVE</b> , <b>AMP COR</b> stores the current amplitude-correction factors table in analyzer memory or on the memory card. When accessed by <b>RECALL</b> , <b>AMP COR</b> recalls the amplitude-correction factors table from either analyzer memory or the memory card. Amplitude-correction factors are saved with an "a" before the memory-card file name. Screen titles are not recalled with the data. Refer to "To Save a Limit-Line Table or Amplitude Correction Factors" in Chapter 1 for more information.  Amplitude-correction-factor memory-card files can be catalogued using <b>CATALOG AMP COR</b> .
AMP COR ON OFF	turns the current table of amplitude-correction factors on and off.
<b>AMPLITUDE</b>	activates the reference level function and accesses the amplitude menu. The softkeys accessed when you press <b>AMPLITUDE</b> change reference level, input attenuation, vertical scale, mixer level, amplitude units, input impedance, and amplitude offset. For the HP 8593A, HP 8594A, or HP 8595A, pressing <b>AMPLITUDE</b> accesses the preselector peaking and preselector default functions also.
AMPTD UNITS	accesses the softkeys that change the amplitude units. The amplitude units can be changed by pressing <b>dBm</b> , <b>dBmV</b> , <b>dBuV</b> , <b>Volts</b> , or <b>Watts</b> .
ANALYZER ADDRESS	<i>Option 021 only.</i> allows you to change the HP-IB address of the analyzer. The analyzer address is set to 18 by pressing <b>DEFAULT CONFIG</b> .
ANNOTATN ON OFF	turns the screen annotation on and off. However, softkey annotation will remain on the screen. The screen annotation may not be required for prints or plots, or during remote operation.

ATTEN  
AUTO MAN

sets the input attenuation in 10 dB increments. The analyzer input attenuator, which is normally coupled (linked) to the reference level control, reduces the power level of the analyzer input signal at the input mixer. The attenuator is recoupled when AUTO is underlined.

---

**Caution**



To prevent damage to the input mixer, the power level at the input mixer must not exceed +30 dBm. To prevent signal compression, power at the input to the input mixer must be kept below -10 dBm.

---

**Note**



To protect the mixer from possible damage, 0 dB RF attenuation (no input power reduction to the mixer) can be selected only from the number/units keypad.

---

AUTO  
ALL

couples the following functions: resolution bandwidth, video bandwidth, attenuation, sweep time, center-frequency step, video bandwidth, and video-bandwidth to resolution-bandwidth ratio.

**AUTO COUPLE**

accesses the softkey menu of functions that can be coupled. (Coupled functions are functions that are linked: if one function is changed, the other function is changed.)

The functions that can be auto-coupled are listed below:

- Resolution bandwidth couples to span.
- Video bandwidth couples to resolution bandwidth when the spectrum analyzer has a video-bandwidth to resolution-bandwidth ratio of 0.3.
- Sweep time couples to span, resolution bandwidth, and video bandwidth.
- RF attenuation couples to reference level.
- Center frequency step size couples to 10% of span.

During normal operation, the sweep time, resolution bandwidth, and video bandwidth are coupled to yield optimum performance. If any of these functions becomes uncoupled (that is, is manually set), a “#” will appear next to the screen annotation representing the function on the screen.

If one or more function(s) is manually set so that the amplitude or frequency becomes uncalibrated, MEAS UNCAL appears on the right side of the graticule.

Recouple a single function by pressing the function label (to activate the function), and pressing the function again so that AUTO is underlined.

Pressing **AUTO COUPLE**, **AUTO ALL** couples all coupled functions listed.

AUTO QP  
AT MKR

*For Option 103 only.*

executes a quasi-peak routine. See the HP 8591A or HP 8593A Option 103 Manual Supplement for more information.

**AUXA** displays the voltage level present at the AUX A connector, A7J7, that is on the A7 Analog Interface assembly. This is a service diagnostic function and is for service use only.

**AUXB** *HP 8590B or HP 8591A only.*  
displays the voltage level present at an unused input to the Test Point MUX circuitry located on the A7 Analog Interface assembly. This is a service diagnostic function and is for service use only.

**AUX CONN CONTROL** accesses the softkey menu used to control the auxiliary outputs and input. The auxiliary outputs are controlled by pressing **CNTL A 0 1**, **CNTL B 0 1**, **CNTL C 0 1**, and **CNTL D 0 1**. The status of the auxiliary input (control line I), can be displayed on the analyzer screen with **DISPLAY CNTL I**.

**AUX CTRL** accesses the softkey menu used for control of the auxiliary interface connector.  
*For the HP 8592B, HP 8593A, and HP 8595A:* **AUX CTRL** also accesses the comb generator function.

*For Option 102 or 103:* **AUX CTRL** also accesses demodulation functions.

**B -> C** moves trace B into trace C.

**B <--> C** exchanges trace B and trace C. Trace B is set to the view mode.

**B-DL -> B** subtracts the display line from trace B and places the result in trace B. The **B-DL -> B** function is a math operation. See the **A-B -> A ON OFF** softkey description for information about math operations.

**B & W PRINTER** *Option 021 or 023 only.*  
selects a black and white print. Use this function if you have a black and white printer, or if you are using an HP PaintJet printer, but want to have a black and white print. Pressing **DEFAULT CONFIG** selects the **B & W PRINTER** softkey.

**BAND LOCK** *HP 8592B, HP 8593A, and HP 8595A only.*  
accesses the harmonic band menu and the band lock function.

Selecting a harmonic band causes the analyzer to lock onto the specified harmonic band and automatically select the settings shown.

**Table 3-2. Center Frequency and Span Settings for Harmonic Bands**

Softkey	Center Frequency	Span	Description
0-2.9 Gz BAND 0	1.45 GHz	2.9 GHz	Low-pass filtered, first harmonic mixing.
2.75-6.4 BAND 1	4.475 GHz	3.6 GHz	Preselected, first harmonic mixing.
2.75-6.5 BAND 1 *	4.475 GHz	3.6 GHz	Preselected, first harmonic mixing.
6.0-12.8 BAND 2 †	9.4 GHz	6.8 GHz	Preselected, second harmonic mixing.
12.4-19.4 BAND 3 †	15.9 GHz	7 GHz	Preselected, third harmonic mixing.
19.1-22 BAND 4 †	20.55 GHz	2.9 GHz	Preselected, fourth harmonic mixing.
* Available only for an HP 8595A.			
† Available only for an HP 8592B or HP 8593A.			

The band lock softkey, **BND LOCK ON OFF**, locks the analyzer onto a selected frequency band (local oscillator harmonic number). When only one frequency band is being swept the corresponding softkey will be underlined, even if band lock is off.

---

**Note**

When using the analyzer in a band lock mode, the span is limited to 3.6 GHz in band 0 and 1, and to 7 GHz in bands 2 through 4. To select the maximum span in a given band, use the start frequency, stop frequency, or span function.

---

**BAUD RATE**

*Option 023 (RS-232 interface) only.*

allows you to set the data transmission speed. (Also see the description for the **COPY** key.) The baud rate is set to 1200 by pressing **DEFAULT CONFIG**.

**BINARY SPAN**

*HP 8592B, HP 8593A, or HP 8595A only.*

displays the output of the span DAC that is located on the A7 Analog Interface assembly. This is a service diagnostic function and is for service use only.

**BLANK A**

stores the amplitude data for trace A and removes it from the screen. The trace A register will not be updated as the analyzer sweeps.

**BLANK B**

stores the amplitude data for trace B and removes it from the screen. The trace B register will not be updated as the analyzer sweeps.

**BLANK C**

stores the amplitude data for trace C and removes it from the screen. The trace C register will not be updated as the analyzer sweeps.

**BLANK CARD**

*Requires Option 003 for an HP 8590B or HP 8592B.*

deletes all the files from the memory card. Pressing **BLANK CARD** displays the message: **IF YOU ARE SURE, PRESS KEY AGAIN TO PURGE DATA**. Press **BLANK CARD** again if you want to delete all files from the memory card.

**BND LOCK ON OFF**

*HP 8592B, HP 8593A, and HP 8595A only.*

**BND LOCK ON OFF (ON)** locks the analyzer to the lowest frequency band (local oscillator harmonic number) containing the current center frequency. Start and stop frequencies will be changed if necessary. Executing a band lock limits the analyzer's tuning range to the selected harmonic number. Selecting the softkeys for band 0 through band 4 turns on the band lock function automatically.

If the start frequency is well within a lower band, turning band lock off will result in a multiband sweep. If a specific band had been selected prior to changing to a multiband sweep, the selected band's softkey label will no longer be underlined indicating that it is not selected. Sweep of a single band is indicated by the selected band's softkey label being underlined.

---

**Note**

Before changing the frequency range to another harmonic, unlock the band by pressing **BND LOCK ON OFF** so that **OFF** is underlined.

---



**BW**

activates the resolution bandwidth function and accesses the softkeys that control the bandwidth functions: RES BW AUTO MAN , VID BW AUTO MAN , VBW/RBW RATIO , VID AVG ON OFF , 9 kHz EMI BW , and 120 kHz EMI BW . (Also see the RES BW AUTO MAN softkey description.)

**CAL**

accesses the softkey menus used for the self-calibration, service-diagnostics, and service-calibration functions. For more information about self-calibrating the analyzer, see "Improving Accuracy with Self-Calibration Routines" in Chapter 1.

**CAL  
AMPTD**

initiates an amplitude self-calibration routine. Connect CAL OUT to the analyzer input before pressing CAL AMPTD . If Option 105 is installed, remove the cable from GATE INPUT before starting the self-calibration routine.

---

**Note**



If the frequency calibration and amplitude calibration self-calibration routines are both used, the CAL FREQ softkey function should always be initiated before the CAL AMPTD softkey function.

---

**CAL  
FETCH**

retrieves stored self-calibration correction factors. You can retrieve previously stored correction factors by pressing CAL FETCH .

**CAL  
FREQ**

initiates a frequency self-calibration routine. Connect CAL OUT to the analyzer input before pressing CAL FREQ . If Option 105 is installed, remove the cable from GATE INPUT before starting the self-calibration routine.

**CAL FREQ  
& AMPTD**

initiates both the frequency and amplitude self-calibration routines. Connect CAL OUT to the analyzer input before pressing CAL FREQ & AMPTD . If Option 105 is installed, remove the cable from GATE INPUT before starting the self-calibration routine.

**CAL MXR**

*HP 8592B, HP 8593A, or HP 8595A only.*

adjusts the bias-current DAC setting for the optimum displayed-signal amplitude, using the 100 MHz COMB OUT signal. This is a service calibration function and is for service use only.

**CAL  
STORE**

copies the correction factors from working RAM to a memory area that allows the stored correction factors to be automatically retrieved when the analyzer is turned on. If correction factors are not stored, they will be retained only until the analyzer is turned off.

**CAL  
TIMEBASE**

changes the setting of the 10 MHz reference (standard timebase) DAC that is located on the A25 Counter Lock assembly. This is a service calibration function and is for service use only.

**CAL  
TRK GEN**

*Option 010 or 011 only.*

performs absolute amplitude, vernier, and tracking peak self-calibration routines. The analyzer should be amplitude calibrated by pressing CAL AMPTD prior to using the CAL TRK GEN function. Connect the tracking generator output to the analyzer input before pressing CAL TRK GEN .

CAL YTF	<i>HP 8592B, HP 8593A, and HP 8595A only.</i> generates the best slope and offset adjustment for each harmonic band's YIG-tuned preselector filter. Connect COMB OUT to the analyzer input before pressing CAL YTF . (The CAL YTF function turns on the comb generator.) The frequency self-calibration routine should be performed before running the CAL YTF routine. CAL YTF should be performed before pressing PRESEL DEFAULT .
CARD CONFIG	<i>Requires Option 003 for an HP 8590B or HP 8592B.</i> accesses the softkey menu that allows you to catalog, format, and delete data from a memory card.
CARD ->DLP	<i>Requires Option 003 for an HP 8590B or HP 8592B.</i> recalls into the analyzer memory a downloadable program (DLP) saved on the memory card. Before recalling data that was saved under a prefix other than the current prefix, change the current prefix to the prefix used when the data was saved. Pressing LOAD FILE is an alternate way to load program data from the memory card into analyzer memory. See "Saving and Recalling Data from the Memory Card" in Chapter 1 for more information. See also the CHANGE PREFIX softkey description.
CARD ->STATE	<i>Requires Option 003 for an HP 8590B or HP 8592B.</i> recalls into analyzer memory a state saved on the memory card. CARD ->STATE also displays the time and date when the state data was stored. Before recalling a state that was saved under a prefix other than the current prefix, change the current prefix to the prefix used when the state was saved. Pressing LOAD FILE is an alternate way to load state data from the memory card into analyzer memory. See "Saving and Recalling Data from the Memory Card" in Chapter 1 for more information.
CARD ->TRACE	<i>Requires Option 003 for an HP 8590B or HP 8592B.</i> recalls into analyzer memory a trace saved on the memory card. Limit lines and amplitude correction factors are recalled by pressing CARD ->TRACE , LIMIT LINES or AMP COR . If the screen title does not exceed 34 characters, time and date when the trace data was stored is also displayed with the recalled trace data. The screen title and date are not recalled with limit-line files or amplitude correction factor files. Before recalling a trace, limit-line file, or amplitude correction factors file that was saved under a prefix other than the current prefix, change the current prefix to the prefix used when the data was saved. Pressing LOAD FILE is an alternate way to load trace data (but not recommended for recalling limit-line files or amplitude correction factor files) from the memory card into analyzer memory. See "Saving and Recalling Data from the Memory Card" in Chapter 1 for more information.
CATALOG ALL	catalogs all the programs and variables stored in analyzer memory. Press CATALOG REGISTER to catalog states, traces, limit-line tables, and amplitude correction factors saved in analyzer memory. Pressing CATALOG ALL catalogs all traces, states, amplitude correction factors, programs, and limit-line tables stored on the memory card when cataloging the memory card.
CATALOG AMP COR	<i>Requires Option 003 for an HP 8590B or HP 8592B.</i> catalogs the amplitude correction factor files that are on the memory card.

### 3-22 Analyzer Functions

Use the CATALOG REGISTER softkey to catalog amplitude factors saved in analyzer memory (amplitude correction factors saved in analyzer memory are stored in trace registers). Amplitude correction factors are saved with an "a" before the memory card file name. Amplitude factors can be saved in analyzer memory by either loading in amplitude correction factors from a memory card, defining amplitude correction factors using a remote programming command (AMPCOR), or using EDIT AMP CORR. See "Entering Amplitude Correction Factors" in Chapter 1 for more information.

**CATALOG CARD**

*Requires Option 003 for an HP 8590B or HP 8592B.*

accesses a menu with the cataloging functions for the memory card: CATALOG ALL, CATALOG STATES, CATALOG TRACES, CATALOG PREFIX, CATALOG DLP, CATALOG AMP CORR, and CATALOG LMT LINE. Each catalog function displays catalog information and accesses a menu containing LOAD FILE and DELETE FILE. The catalog contains information about the data stored on the memory card. (See Figure 3-1 and Table 3-3.)

Use the step keys to view different sections of the directory, and the knob to select a file. Press LOAD FILE to load the selected file into analyzer memory. Press DELETE FILE to delete the selected file from the memory card.

Unlike saving to the internal memory, data is saved as a file on the memory card. The files stored on the memory card are in the logical interchange format (LIF).

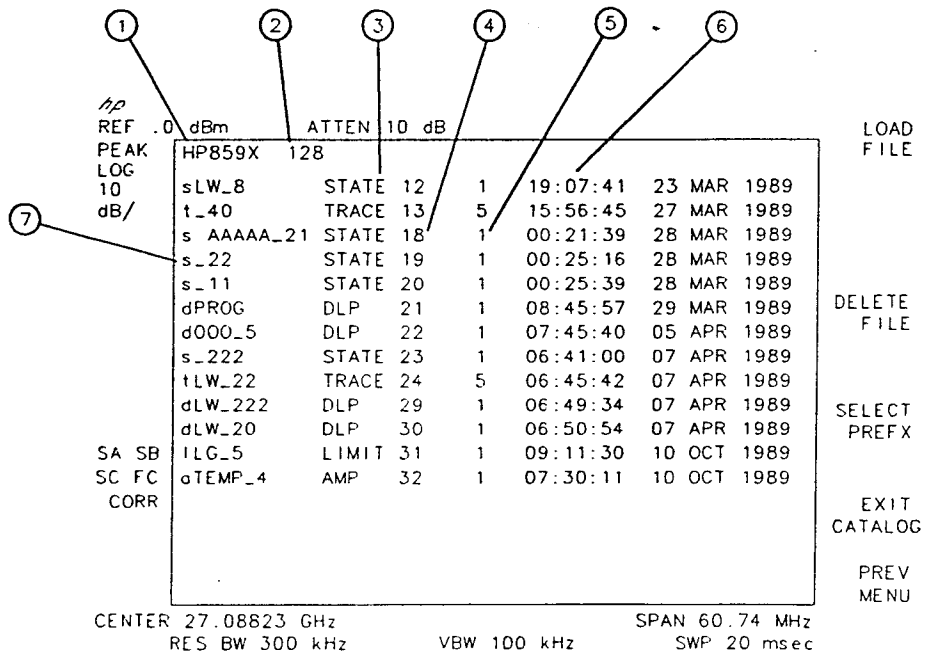

**Figure 3-1. Memory Card Catalog Information**

Table 3-3. Memory Card Catalog Information

Item	Title	Description
1	Volume Label	A label to identify the memory card. <b>FORMAT CARD</b> automatically assigns the volume label "HP859X" to the card.
2	Number of kilobytes	Displays the size of the memory card. 128 is the number of 256-byte blocks or records. 128 indicates that the card is a 32-kilobyte memory card (128 blocks × 256 bytes per block) per 1024 bytes per kilobyte.
3	Data Type	Indicates the type of data—trace, state, downloadable program (DLP), limit line (LIMIT), amplitude factors (AMP). The data type is determined by the letter t, s, d, l, or a preceding the filename.
4	Starting Address	Indicates the physical record number of the start of the file.
5	File Length	Indicates number of records in the file.
6	Time of Creation	Indicates the time and date of file creation.
7	File name	The letter preceding the file name indicates the type of data of the file: t = trace data, s = state data, d = program data (downloadable program), l = limit line, a = amplitude factors. If the data was saved using a prefix, the prefix follows the first character in the file name. An underscore and the register number follow the prefix.

**CATALOG  
DLP**

catalogs all of the downloadable programs (DLPs) that are in analyzer memory or on the memory card. Downloadable programs can be saved in analyzer memory by either loading in a downloadable program from the memory card or defining a function using remote programming commands (FUNCDEF or ACTDEF).

**CATALOG  
INTRNL**

accesses a menu that has the cataloging functions for analyzer memory: **CATALOG ALL**, **CATALOG REGISTER**, **CATALOG VARIABLES**, **CATALOG PREFIX**, and **CATALOG DLP**. Each catalog function displays catalog information. The catalog contains information about the data stored in internal memory. See Figure 3-2 and Table 3-4.

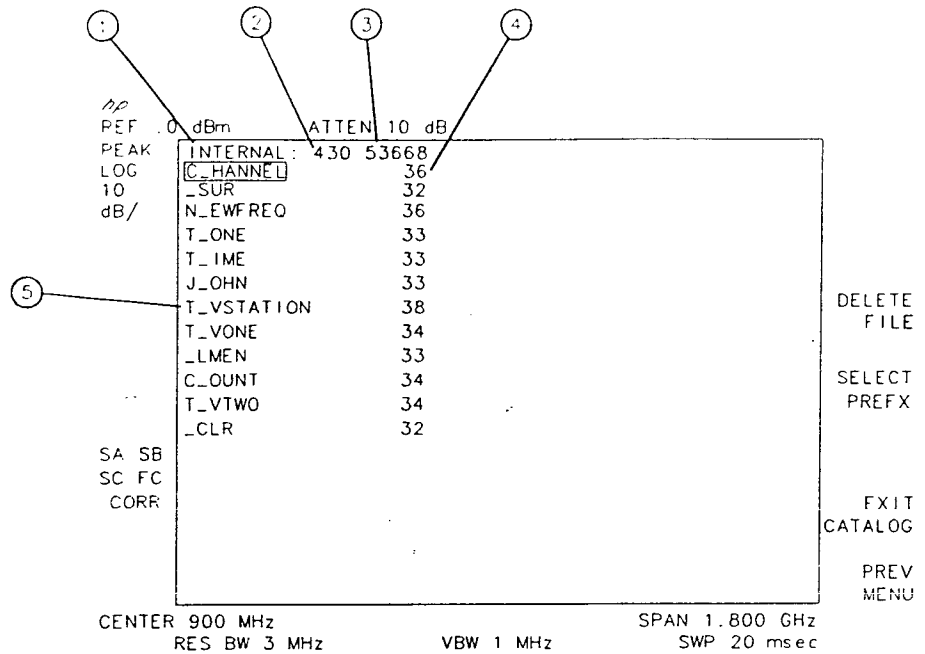

Figure 3-2. Analyzer Memory Catalog Information

Table 3-4. Analyzer Memory Catalog Information\*

Callout Number	Description
1	Name of the catalog source.
2	Bytes of spectrum analyzer memory used.
3	Bytes of spectrum analyzer memory available.
4	Bytes used by item.
5	Name of item.

\* This table is not applicable when using CATALOG REGISTER .

Unlike saving to the memory card, data is saved as an item in analyzer memory.

Use the step keys to view different sections of the directory, and the knob to select a file. The selected file is highlighted in inverse video.

Except for CATALOG REGISTER, each of the catalog softkey functions access the menu that has the DELETE FILE function. Use DELETE FILE to delete the item from analyzer memory.

Pressing CATALOG REGISTER accesses a menu that has the LOAD FILE function. Use LOAD FILE to load a state or trace from analyzer memory. Do not use LOAD FILE to load limit-line table and amplitude correction factor items.

Also see the CATALOG ALL and CATALOG VARIABLES softkey descriptions.

CATALOG  
LMT LINE

Requires Option 003 for an HP 8590B or HP 8592B.  
catalogs the limit-lines on the memory card. Press CATALOG REGISTER to catalog limit-line tables stored in analyzer memory (limit-line tables saved in analyzer memory are stored in trace registers).

CATALOG  
ON EVENT

displays the "on event" programming commands and their status. The on event programming commands are as follows:

- ONEOS Performs command list at end of every sweep.
- ONSWP Performs command list at beginning of every sweep.
- TRMATH Performs trace math.
- ONCYCLE Performs command list periodically.
- ONDELAY Performs command list once after a time period.
- ONMKR Performs command list at the marker.
- ONSRQ Performs command list on every service request.
- ONTIME Performs command list at a specific time.

The on event programming commands can be set remotely; see the *HP 8590 Series Programming Manual* for more information about setting the commands.

When the on event programming commands have not been set, or when an instrument preset has been performed, pressing CATALOG ON EVENT displays the status of the on event programming commands as UNDEFINED. If the ONEOS, ONSWP, TRMATH, ONMKR, and ONSRQ commands have been set, pressing CATALOG ON EVENT displays their status as ACTIVE. When ONCYCLE, ONDELAY, or ONTIME have been set, pressing CATALOG ON EVENT displays the information in Table 3-5. (See Figure 3-3.)

**Table 3-5. CATALOG ON EVENT Display Description**

Programming Command	Description of CATALOG ON EVENT Display
ONCYCLE	The number of seconds left until the event occurs, followed by the number of seconds ONCYCLE was set for.
ONDELAY	CATALOG ON EVENT displays either a positive number or negative number of seconds. A positive number indicates the number of seconds left until the event occurs. A negative number indicates the number of seconds that has passed since the event occurred.
ONTIME	The date (in year, month, and day format) and the time (in 24 hour format) that ONTIME is set for.

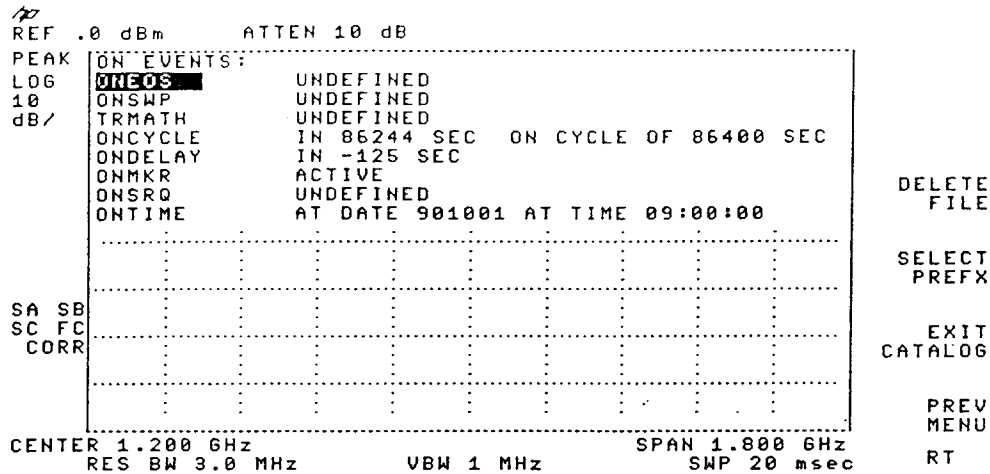

Figure 3-3. CATALOG ON EVENT Display

**CATALOG PREFIX**

catalogs all of the saved data, that has the specified prefix, that is either on the memory card or in analyzer memory. The entire prefix does not have to be specified. For example, if you want to catalog all the files beginning with the prefix S, specify S as the prefix and then use **CATALOG PREFIX**. Prefixed items can be saved in analyzer memory by either loading in a downloadable program from the memory card or using remote programming commands to define a function.

**CATALOG REGISTER**

displays the status of state and trace registers in analyzer memory. States 1 through 8 are displayed with the center frequency (denoted by CF) and span (denoted by SP). The status of trace registers 0 to the maximum number of traces is displayed also. If a trace, limit-line tables, or amplitude correction factors have been saved in the trace register, the screen title (denoted by "TL:") is displayed. If the screen title length allows, or if no title is saved with the trace, the time and date are displayed. To load the contents of the state or trace register into analyzer memory, use the knob or step keys to select the register and press **LOAD FILE**.

**Note**



Do not use **LOAD FILE** to load the contents of a trace register containing limit-line tables or amplitude correction factors.

**CATALOG STATES**

*Requires Option 003 for an HP 8590B or HP 8592B.*  
catalogs all of the states stored on the memory card.

**CATALOG TRACES**

*Requires Option 003 for an HP 8590B or HP 8592B.*  
catalogs all of the traces stored on the memory card.

**CATALOG VARIABLES**

catalogs all of the variables saved in analyzer memory. Variables can be saved in analyzer memory by loading in a downloadable program from the memory card or defining a function using remote programming commands (**VARDEF** or **TRDEF**).

---

**Note**

Variables beginning with an underscore are used by the analyzer firmware. Modifying these is not recommended and may give unexpected results.

---

**CENTER  
FREQ**

activates the center-frequency function to allow the selection of frequency that will be at the center of the screen.

**CF STEP  
AUTO MAN**

changes the step size for the center frequency function. Once a step size has been selected and the center frequency function is activated, the step keys change center frequency by the step-size value. The step size function is useful for finding harmonics and sidebands beyond the analyzer's current frequency span. When auto-coupled, the center frequency step size is set to one graticule (10% of the span).

**CHANGE  
PREFIX**

allows you to enter a prefix that can be used for saving and recalling data to and from the memory card, and for cataloging by the prefix. The prefix can be from one to seven characters long. The longer the prefix, the shorter the register number must be. The total length of the prefix and register number cannot exceed eight characters. The prefix can be any character; however, the underscore should not be the first character of the prefix. Pressing **CHANGE PREFIX** accesses a menu containing the letters of the alphabet, the underscore symbol ( ), the number symbol (#), a space, and the clear function. To select a character, press the softkey that displays the group of characters that contains the desired character. The softkey menu changes to allow you to select an individual character. If you make a mistake, press **(BK SP)** to space back over the incorrect character. Additional characters are available by pressing **MORE 1** of **2**. Numbers may be selected with the numeric keypad.

A prefix can be cleared with the clear function. Press **(CONFIG)** or **(DISPLAY)**, **CHANGE PREFIX**, **YZ\_# SPC CLEAR**, **CLEAR** to clear the current prefix. The current prefix is set to blank by pressing **DEFAULT CONFIG**.

**CHANGE  
TITLE**

allows you to write a 53-character screen title across the top of the screen. The marker readout may interfere with the last 26 characters. The markers can be turned off by pressing **(MKR)**, **MARKERS OFF**. Pressing **CHANGE TITLE** accesses the softkey menus that contain the characters and symbols available. The screen title will remain on the screen until either **CHANGE TITLE** is pressed again, **(PRESET)** is pressed, the screen title is cleared by pressing **CLEAR**, or a trace is recalled that was saved with a screen title.

Pressing **CHANGE TITLE** accesses a menu containing the letters of the alphabet, the underscore symbol ( ), the number symbol (#), a space, and the **CLEAR** softkey. To select a character, press the softkey that displays the group of characters that contains the desired character. The softkey menu changes to allow you to select an individual character. If you make a mistake, press **(BK SP)** to space back over the incorrect character. Additional characters are available by pressing **MORE 1** of **2**. Numbers may be selected by using the numeric keypad.



A screen title can be cleared by using the clear function. Press **DISPLAY**, **CHANGE TITLE**, **YZ\_# SPC CLEAR**, **CLEAR** to clear the current screen title. Pressing **RPG TITLE** provides additional characters for the menu accessed by pressing **CHANGE TITLE**. Pressing **RPG TITLE** provides lowercase letters, numbers, Greek letters, and punctuation symbols. To access additional characters, press **RPG TITLE**. When **RPG TITLE** is pressed, a character table appears on the screen. To select a character, turn the knob to position the cursor under the desired character and press the **ENTER** key. The step keys move the cursor between rows. When all desired characters have been entered, press **HOLD**. All other analyzer functions are inoperative until **HOLD** is pressed.

**CLEAR** clears the current screen title or prefix.

**CLEAR OFFSET** *HP 8592B only.* clears the frequency offset added by the correct-to-comb routine. See the **CORRECT TO COMB** softkey description.

**CLEAR QP DATA** *For Option 103 only.* clears the displayed quasi-peak amplitude and quasi-peak marker (represented by a diode symbol) from the analyzer screen. See the HP 8591A or HP 8593A Option 103 Manual Supplement for more information.

**CLEAR WRITE A** erases any data previously stored in trace A and continuously displays any signals detected in the frequency range of the analyzer. This function is activated at power on and by pressing **PRESET**.

Changing the trace mode of trace C to clear write or minimum hold can change the trace mode of trace A. If trace A is in clear-write mode or maximum-hold mode when trace C is changed to clear write or minimum hold, the trace mode of trace A is changed to store blank.

The following table shows the trace mode of trace A before and after changing trace C to clear-write or minimum-hold trace mode.

Trace Mode of Trace A Before	Trace Mode of Trace A After
Clear write	Store blank
Maximum hold	Store blank
View	View

Changing the trace mode of trace A to clear write or maximum hold can change the trace mode of trace C. If trace C is in clear-write mode when trace A is changed to clear write or minimum hold, the trace mode of trace C is changed to minimum hold.

Trace Mode of Trace C Before	Trace Mode of Trace C After
Clear write	Minimum hold
Minimum hold	Minimum hold
View	View

**CLEAR  
WRITE B**

erases any data previously stored in trace B and continuously displays any signals detected in the frequency range of the analyzer. This function is activated at power on and by pressing **PRESET**.

Changing the trace mode of trace C to clear write or minimum hold can change the trace mode of trace B. If trace B is in clear-write mode or maximum-hold mode when trace C is changed to clear write or minimum hold, the trace mode of trace B is changed to store blank.

The following table shows the trace mode of trace B before and after changing trace C to clear-write or minimum-hold trace mode.

Trace Mode of Trace B Before	Trace Mode of Trace B After
Clear write	Store blank
Maximum hold	Store blank
View	View

Changing the trace mode of trace B to clear write or maximum hold can change the trace mode of trace C. If trace C is in clear-write mode when trace B is changed to clear write or minimum hold, the trace mode of trace C is changed to minimum hold.

Trace Mode of Trace C Before	Trace Mode of Trace C After
Clear write	Minimum hold
Minimum hold	Minimum hold
View	View

**CLEAR  
WRITE C**

erases any data previously stored in trace C and continuously displays any signals detected in the frequency range of the analyzer. This function is activated at power on and by pressing **PRESET**.

Changing the trace mode of trace C to clear write or minimum hold can change the trace mode of trace A and trace B. If trace A or trace B is in clear-write mode or maximum-hold mode when trace C is changed to clear write or minimum hold, the trace mode of trace A or trace B is changed to store blank.

### 3-30 Analyzer Functions

The following table shows the trace mode of trace A or trace B before and after changing trace C to clear-write or minimum-hold trace mode.

Trace Mode of Trace A or B Before	Trace Mode of Trace A or B After
Clear write	Store blank
Maximum hold	Store blank
View	View

If you want to use trace A or trace B in the clear-write or maximum-hold mode and do not want trace C to blank it, use minimum-hold or view-trace mode for trace C.

CNTL A  
0 1

makes the auxiliary-interface control line A output high or low (TTL).

CNTL B  
0 1

makes the auxiliary-interface control line B output high or low (TTL).

CNTL C  
0 1

makes the auxiliary-interface control line C output high or low (TTL).

CNTL D  
0 1

makes the auxiliary-interface control line D output high or low (TTL).

CNT RES  
AUTO MAN

*HP 8591A, HP 8593A, HP 8594A, and HP 8595A only.*

selects the resolution of the marker counter. The marker counter has a resolution range of 10 Hz to 100 kHz. The available resolution values are 1 Hz, 10 Hz, 100 Hz, 1 kHz, 10 kHz, and 100 kHz. The 1 Hz marker counter resolution is not specified. The resolution can be changed by using the step keys or by entering the resolution using the numeric keypad. The marker counter resolution can be auto coupled to the span by pressing CNT RES AUTO MAN so that AUTO is underlined. The CNT RES AUTO MAN softkey function is not affected by pressing AUTO ALL.

COARSE  
TUNE DAC

displays the analog output of the YTO coarse-tune DAC located on the A7 Analog Interface assembly. This is a service diagnostic function and is for service use only.

COMB GEN  
ON OFF

*HP 8592B, HP 8593A, and HP 8595A only.*

turns the internal comb generator on (when ON is underlined) or off (when OFF is underlined). Connect a cable between 100 MHz COMB OUT and the analyzer input.

CONFIG

accesses the softkey menu used for printer and plotter configurations, the time and date display functions, changing the current prefix, memory card configuration functions, disposing of user-defined variables and programs from analyzer memory, changing the analyzer address or the baud rate, and displaying the installed option on screen. Pressing CONFIG after the analyzer has been placed in the remote mode places the analyzer in the local mode and

enables front-panel control. During remote operation, an R appears in the lower-right corner of the screen indicating remote mode. Pressing **CONFIG** removes the R annotation from the lower-right corner.

**CONF  
TEST**

initiates a variety of tests to check the major functions of the analyzer. The confidence test function checks that the video bandwidths change, the noise floor level decreases as the resolution bandwidth narrows, the step gains switch, and the 3 dB bandwidths of the resolution bandwidths are correctly set. CNF TEST PASS is displayed if the confidence test passes.

**CONTINUE**

*HP 8592B only.*

changes the frequency offset to match the marker frequency and exits the correct-to-comb routine. See the **CORRECT TO COMB** softkey description.

**COPY**

*Option 021 or 023 only.*

initiates an output of the screen data, without an external controller, to a previously specified graphics printer or plotter. The printer or plotter must have already been selected using **CONFIG** and either **PLOT CONFIG** (for a plotter) or **PRINT CONFIG** (for a printer). To obtain a print, press **CONFIG**, **COPY PRNT PLT** (so that PRNT is underlined), then **PRINT CONFIG**. For Option 021, use **PRINTER ADDRESS** to change the HP-IB address of the printer, if necessary. For Option 023, use **BAUD RATE** to change the baud rate of the analyzer, if necessary.

If the analyzer is connected to an HP PaintJet printer and you want a color printout, press **PAINTJET PRINTER**. If the analyzer is connected to an HP PaintJet printer and you want a black and white printout, press **B & W Printer**.

If you want the softkey labels to be printed with the analyzer display printout when using **COPY**, press **PRT MENU ON OFF** so that ON is underlined.

Press **COPY** and the process will begin. The screen remains frozen (no further sweeps taken) until the data transfer to the printer is complete. The analyzer works with many Hewlett-Packard printers.

The plotting process is similar to the printing process. On the analyzer, press **CONFIG**, **PLOT CONFIG**. For Option 021, use **PLOTTER ADDRESS** to change the HP-IB address for the plotter, if necessary. For Option 023, use **BAUD RATE** to change the baud rate of the analyzer, if necessary.

With **PLTS/PG 1 2 4**, you can choose a full-page, half-page, or quarter-page plot. Press **PLTS/PG 1 2 4** to underline the number of plots per page desired. If two or four plots per page are chosen, a softkey function is displayed that allows you to select the location of the plotter output on the paper. If two plots per page are selected, **PLT [ ]LOC \_ \_** is displayed. If four plots per page are selected, **PLT [ ]LOC \_ \_** is displayed. Press the softkey until the rectangular marker is in the desired section of the softkey label. The upper and lower sections of the softkey label graphically represent the position of the page where the plotter output will be located.

---

**Note**

The HP 7470A Plotter does not support two plots per page output. If you use an HP 7470A Plotter with an HP 8590 Series Spectrum Analyzer, you can select one or four plots per page, but not two plots per page.

---

For a multipen plotter, the pens of the plotter draw the different components of the screen as follows:

Pen Number	Description
1	Draws the annotation and graticule.
2	Draws trace A.
3	Draws trace B.
4	Draws trace C and the display line.
5	Draws user-generated graphics and the lower limit line.
6	Draws the upper limit line.

To plot, press **PREV MENU**, **COPY DEV PRNT PLT** (PLT should be underlined), and **COPY**.

Printing is usually faster than plotting, but plotting provides higher resolution output. The analyzer works with plotters such as the HP 7440A.

Figure 3-4 shows the rear view of a typical printer/spectrum-analyzer configuration.

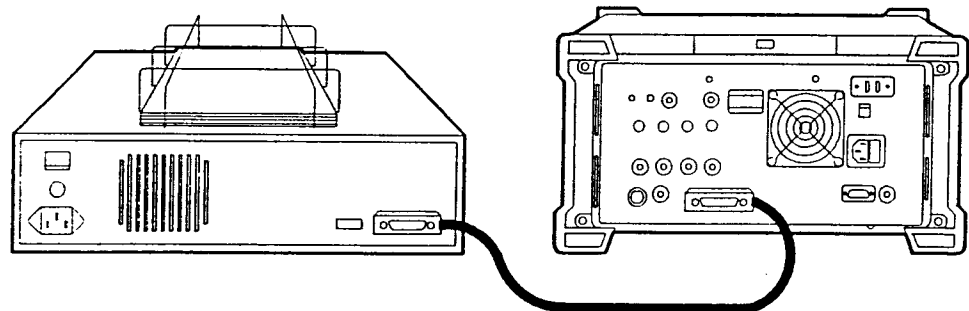

**Figure 3-4. Connecting a Printer to the Analyzer**

---

**Note**

Printing and plotting require an optional interface. Generally, spectrum analyzers with an HP-IB interface set the plotter address to 5 and the printer address to 1. Spectrum analyzers with an RS-232 interface must have the baud rate set to match the baud rate of the printer or plotter being used. The programming manual that comes with the optional interfaces details peculiarities of the different interfaces. Refer to the *HP 8590 Series Programming Manual* for more information about printing and plotting.

---

COPY DEV  
PRNT PLT

*Option 021 or 023 only.*

changes between a printer and plotter. For example, if you have been printing and want to do a plot, press COPY DEV PRNT PLT to underline PLT before pressing **COPY**.

CORRECT  
ON OFF

controls use of some of the correction factors. When ON is underlined, correction factors are used and CORR appears on the display. When OFF is underlined, correction factors are not used. Turning the correction factors off degrades amplitude accuracy.

---

**Note**



Correction factors must be on for the spectrum analyzer to meet its specified performance.

---

CORRECT  
TO COMB

*HP 8592B only.*

increases the frequency accuracy by adding a frequency offset to the comb frequency to correct the frequency readout. Pressing **CORRECT TO COMB** accesses a softkey menu that has **PEAK SEARCH**, **NEXT PK LEFT**, **NEXT PK RIGHT**, **CLEAR OFFSET**, **ABORT**, and **CONTINUE**. A message, **SET MARKER ON COMB TOOTH THEN PRESS 'CONTINUE' SOFTKEY TO CORRECT FREQ OFFST**, is displayed on the analyzer screen. Place the marker on the nearest comb signal, and either press **CONTINUE** if you want to add a frequency offset, or press **ABORT** if you want to exit the correct-to-comb routine without adding a frequency offset. The span should be greater than 17 MHz and less than or equal to 400 MHz before using the correct-to-comb routine.

---

**Caution**



Do not use dc coupling if there is any dc voltage at the spectrum analyzer input.

---

COUPLE  
AC DC

*HP 8594A or HP 8595A only.*

allows you to select alternating-current (AC) or direct-current (DC) coupling at the spectrum analyzer input. Selecting ac coupling blocks any dc voltage at the spectrum analyzer input; however, the ac coupling also decreases the frequency range of the spectrum analyzer. The input coupling is set to ac by an instrument preset.

Specifications apply only when coupling is set to dc.

CRT HORZ  
POSITION

changes the horizontal position of the signal on the analyzer display. Press **CAL STORE** if you want the analyzer to use this position when power is turned on.

CRT VERT  
POSITION

changes the vertical position of the signal on the analyzer display. Press **CAL STORE** if you want the analyzer to use this position when power is turned on.

DACS

changes the DAC numbers of the span, DAC YTO coarse-tune, DAC YTO fine-tune, and YTO FM tune DAC located on the A7 Analog Interface assembly. This is a service diagnostic function and is for service use only.

**DATEMODE** changes the display of the date from a month-day-year format to a day-month-year format. It is set to a month-day-year format by pressing **DEFAULT CONFIG**.

**MDY DMY**

**dBm** changes the amplitude units to dBm for the current setting (log or linear).

**dBmV** changes the amplitude units to dBmV for the current setting (log or linear).

**dBuV** changes the amplitude units to dB $\mu$ V for the current setting (log or linear).

**DEFAULT CAL DATA** accesses the predetermined correction factors. A special pass code is required for use. See Chapter 5 in the Installation and Verification Manual for your instrument for more information.

**DEFAULT CONFIG** resets the analyzer configuration to the state it was in when it was originally shipped from the factory and performs an instrument preset. See Table 3-5 for the default user-configuration values set by pressing **DEFAULT CONFIG**.

**Table 3-5. Default Configuration Values**

Configuration	Default Value
Analyzer address (Option 021)	18
Copy device	printer
CRT position (Horizontal and Vertical)	10, 48
Printer address (Option 021 or 023)	1
Plotter address (Option 021 or 023)	5
Baud rate (Option 023)	1200
External preamp	0 dB
Save lock (internal states or traces)	Off
Printer	black and white printer
Print menu	on
Plots per page	1
Time/date display	on
Date mode	month-day-year format
Prefix	(blank)
Analyzer state at power on	instrument preset

**DELETE FILE** function allows you to delete an item from analyzer memory or a file from the memory card. **DELETE FILE** is not available for deleting state or trace data from analyzer memory (see the **CATALOG REGISTER** softkey description). Use the step keys to view different sections of the directory and use the knob to select the file or item to delete. Pressing **DELETE FILE** causes a message to appear on the analyzer screen: **IF YOU ARE SURE, PRESS KEY AGAIN TO PURGE DATA**. Press **DELETE FILE** again if you want to delete the memory item.

---

**Note**

Deleting items beginning with an underscore from analyzer memory is not recommended and may have unexpected results. Items beginning with an underscore are used by the analyzer.

---

**DELETE  
POINT**

deletes an amplitude-correction factor that was previously selected by **SELECT POINT**.

**DELETE  
SEGMENT**

deletes the limit-line entry for the selected segment number. Press **SELECT SEGMENT** then enter the segment number to select the limit-line entry for deletion.

**DELTA  
MEAS**

finds and displays the frequency and amplitude differences between the two highest-amplitude signals. Pressing **DELTA MEAS** performs the routine similar to pressing the following keys: **PEAK SEARCH**, **MARKER DELTA**, and **NEXT PEAK**.

**DEMODO**

*Option 102 or 103 only.*

accesses the softkeys controlling demodulation functions, speaker volume, squelch level, FM gain, and dwell time.

**DEMODO  
AM FM**

*Option 102 or 103 only.*

allows selection of amplitude (AM) or frequency (FM) demodulation.

Activating AM detection turns off FM demodulation (if it is on). When the frequency span is greater than 0 Hz, a 30 kHz resolution bandwidth is used during demodulation, regardless of the screen annotation. When the span is equal to 0 Hz, the displayed bandwidth is used.

Turning FM demodulation on turns off AM demodulation (if it is on). When the frequency span is greater than 0 Hz, a 100 kHz bandwidth is used during the demodulation, regardless of the screen annotation. When the span is equal to 0 Hz, the displayed bandwidth is used.

**DEMODO  
ON OFF**

*Option 102 or 103 only.*

turns the AM or FM demodulation on and off. If the analyzer is in a nonzero span, a marker is placed at center screen if an on-screen marker is not already present. The marker pause is changed to equal the current dwell time value. Demodulation takes place on any signal that is indicated by the marker position during the marker pause. There is no change to the display during marker pause, but the demodulation signal is present on the AUX VIDEO OUT. Also see the **SPEAKER ON OFF** softkey description.

Pressing **DEMODO ON OFF** selects the sample peak detector for AM demodulation, the FMV detector for FM demodulation. If the analyzer is in zero span, demodulation is done continuously, with or without an on-screen marker.

**DETECTOR  
SAMPL PK**

selects between sample and peak detection. When sample detection is selected, **SMPL** appears in the upper-left corner of the screen. When peak detection is selected, **PEAK** appears in the upper-left corner of the screen. In sample mode, the instantaneous signal value at the present display point is placed in memory. Sample detection is activated automatically for noise level markers, during video averaging, and for FFT measurements. Peak detection



obtains the maximum video signal between the last display point and the present display point and stores this value in the trace memory address. Peak detection is selected at power on and by pressing **PRESET**.

**DISPLAY**

accesses softkeys that activate the display line and threshold, allow title and prefix entry, and control the display of the graticule and screen annotation.

**DISPLAY  
CAL DATA**

displays the current correction-factor data generated by the calibrate frequency and amplitude self-calibration routines. This is a service diagnostic function and is for service use only.

**DISPLAY  
CNTL I**

displays the status of the auxiliary connector input (control line I) on the analyzer screen (high = 1 or low = 0, in TTL).

**DISPOSE  
USER MEM**

allows you to dispose of all the user programs and variables that are in analyzer memory. Pressing **DISPOSE USER MEM** causes a message to appear on the analyzer screen: **IF YOU ARE SURE, PRESS KEY AGAIN TO PURGE DATA**. Press **DISPOSE USER MEM** again if you want to dispose of all the user-defined programs and variables. If you do not want to dispose of all the user programs, press a softkey function other than **DISPOSE USER MEM**. Pressing **DISPOSE USER MEM** does not dispose of limit-line tables or amplitude-correction factors that are in analyzer memory.

---

**Note**



Use **DELETE FILE** to delete stored programs or variables from analyzer memory selectively.

---

Using **DISPOSE USER MEM** may change the printer or plotter configuration. Pressing **DISPOSE USER MEM** sets the printer output to print a black and white print by selecting **B & W PRINTER**, sets the copy device to print when **COPY DEV PRNT PLT** has **PRNT** underlined, and sets the print menu to on when **PRT MENU ON OFF** has **ON** underlined. Use **PRINT CONFIG** to change any of these functions.

**DROOP**

disables the reset of the peak detector on the A16 Processor/Video assembly after each analog-to-digital conversion. This is a service diagnostic function and is for service use only.

**DSP LINE  
ON OFF**

activates an adjustable horizontal line that is used as a visual reference line. The line, which can be used for trace arithmetic, has amplitude values that correspond to its vertical position when compared to the reference level. The value of the display line appears in the active function block and on the left side of the screen. The display line can be adjusted using the step keys, knob, or numeric keypad. To deactivate the display line, press **DSP LINE ON OFF** so that **OFF** is underlined. (Also see the **VIDEO** softkey description.)

**DWELL  
TIME**

*Option 102 or 103 only.*  
sets the dwell time for the marker pause, during which demodulation can take place in nonzero span sweeps. The dwell time can be set from 2 milliseconds to 100 seconds.

EDGE POL            *Option 105 only.*  
 POS NEG            determines whether the gate triggers on the positive-going or negative-going edge of the signal at the GATE TRIGGER INPUT connector (on the rear panel of the spectrum analyzer).

EDIT  
 AMP COR            allows you to edit the current amplitude-correction factors table by accessing the SELECT POINT, SELECT FREQ, SELECT AMPLITUD, DELETE POINT, EDIT DONE, and PURGE AMP COR softkeys.

EDIT  
 DONE                can be accessed through both the amplitude-correction menu and the limit-line menu. When accessed from the amplitude-correction menu, the amplitude-correction factors table is erased from the analyzer's screen and the amplitude-correction menu is restored on-screen. Use EDIT DONE when all the amplitude-correction factors have been entered.

When accessed from the limit-line menu, EDIT DONE erases the limit-line table from the analyzer's screen and restores the menu accessed by the LIMIT LINES softkey. Use EDIT DONE when all the limit-line values have been entered.

EDIT  
 FLATNESS            allows flatness-correction constants to be viewed or modified. This is a service calibration function and is for service use only.

EDIT  
 LIMIT                allows you to edit the current limit-line tables by accessing EDIT UPPER, EDIT LOWER, EDIT UP/LOW, and EDIT MID/DELTA. Use NEW LIMIT to dispose of the current limit-line table.

EDIT  
 LOWER                allows you to view or edit the lower limit-line table. Up to 20 entries are allowed for the lower limit-line table. With the lower limit-line table format, the coordinates for the lower limit-line are specified, but none are specified for the upper limit line. Even if upper limit-line values exist or the values had been entered as an upper and lower limit-line table, the lower limit-line values are treated as a separate table from the upper limit-line values. The lower limit-line entries can have independent frequency and amplitude coordinates from upper limit-line table entries.

EDIT  
 MID/DELT            allows you to view or edit the upper and lower limit-line tables simultaneously. These tables are edited by entering a middle amplitude value and an amplitude deviation. Up to 20 entries are allowed for the upper and lower limit-line tables. Like the upper and lower limit-line table format, the mid/delta limit-line table format provides a means of specifying the upper and lower limit lines at the same time. Unlike the upper and lower table format, the amplitude values are specified as a middle amplitude value with a delta (the upper and lower limit lines are drawn an equal positive and negative distance from the middle amplitude). With the mid/delta format, the frequency and the middle amplitude plus the delta comprise the upper limit line; the frequency and the middle amplitude minus the delta comprise the lower limit line. The difference between the mid/delta and the upper/lower format is the way the amplitude values are entered; the frequency coordinate begins a segment regardless of the format chosen. The mid/delta format can be used if the upper and lower limit lines are symmetrical with respect to the amplitude axis.

EDIT  
UP/LOW

allows you to view or edit the upper and lower limit-line tables simultaneously. Up to 20 entries are allowed for the upper and lower limit-line tables. With the upper and lower limit-line table format, the upper and lower limit-lines can be entered at the same time. With the upper and lower limit-line format, the frequency, upper amplitude, and lower amplitude are specified. The frequency and upper amplitude comprise the coordinate point for the upper limit line, the frequency and lower amplitude value comprise the coordinate point for the lower limit line. It is not necessary to specify both an upper and lower amplitude component for every frequency component.

EDIT  
UPPER

allows you to view or edit the upper limit-line table. Up to 20 entries are allowed for the upper limit-line table. With the upper limit-line table format, the coordinates of the upper limit line are specified, but none are specified for the lower limit line). Even if lower limit-line values exist or the values had been entered as an upper and lower limit-line table, the upper limit-line values are treated as a separate table from the lower limit-line values. The upper limit-line entries can have independent frequency and amplitude coordinates from lower limit-line table entries.

EDIT  
UPR LWR

selects upper or lower limit-line tables.

EXECUTE  
TITLE

executes the remote commands that appear in the screen title.

EXIT

exits the EDIT FLATNESS softkey menu. This is a service calibration function and is designed for service use only.

EXIT  
CATALOG

returns the analyzer to the state it was in before the current catalog function was invoked.

EXIT  
SHOW

removes the screen annotation left after pressing **SHOW OPTIONS**.

EXTERNAL

activates the trigger condition that allows the next sweep to start when an external voltage (connected to EXT TRIG INPUT on the rear panel) passes through approximately 1.5 volts. The external trigger signal must be a 0 V to +5 V TTL signal.

EXT  
PREAMP

adds a positive or negative preamplifier gain value, which is subtracted from the displayed signal. The EXT PREAMP function is similar to the REF LVL OFFSET function; however, with the EXT PREAMP function, the attenuation may be changed depending on the preamplifier gain entered. A preamplifier gain offset is used for measurements that require an external preamplifier or long cables. The offset is subtracted from the amplitude readout so that the displayed signal level represents the signal level at the input of the preamplifier. The preamplifier gain offset is displayed at the top of the screen and is removed by entering zero. The preamplifier gain offset is entered using the numeric keypad.

Press CAL STORE if you want the analyzer to use the current preamplifier gain offset when power is turned on. Preamplifier gain offset is set to zero when DEFAULT CONFIG is pressed.

FFT MEAS	transforms zero span data into the frequency domain by using a fast Fourier transform. After using the FFT function, the display is always in log mode, 10 dB per division and single sweep triggering. After using the FFT function, the markers are still in FFT mode for use in evaluating the data. The markers must be turned off before attempting to use them in the usual manner. See Chapter 2, "Measuring Amplitude Modulation Using the Fast Fourier Transform Function," for more information.
FINE TUNE DAC	displays the output of the YTO fine-tune DAC, which is produced on the A7 Analog Interface assembly. This is a service diagnostic function and is for service use only.
FLAT	draws a zero-slope line between the coordinate point of the current segment and the coordinate point of the next segment, producing limit-line values equal in amplitude for all frequencies between the two points. If the amplitude values of the two segments differ, the limit line "steps" to the frequency value of the second segment.
FLATNESS DATA	provides access to the softkeys used for viewing or editing the flatness-correction constants. This is a service calibration function and is for service use only.
FM COIL DRIVE	displays the output of the FM coil driver produced on the A7 Analog Interface assembly. This is a service diagnostic function and is for service use only.
FM GAIN	<i>Option 102 or 103 only.</i> adjusts the top-to-bottom screen deviation from center screen of the signal (FM demodulation only). The range for FM gain is from 10 kHz to 500 kHz. The default value is 100 kHz.
FM OFFST	<i>Option 102 or 103 only.</i> adjusts the horizontal trace for center-screen with no modulation on the carrier. This is a service diagnostic function and is for service use only.
FM SPAN	displays the FM_SPAN signal from the span dividers on the A7 Analog Interface assembly. This is a service diagnostic function and is for service use only.
FORMAT CARD	formats a card in logical interchange format (LIF). The memory card is formatted with the volume label "HP859X." Pressing <b>FORMAT CARD</b> causes a message to appear on the analyzer screen: <b>IF YOU ARE SURE, PRESS KEY AGAIN TO PURGE DATA.</b> Press <b>FORMAT CARD</b> again if you want to format the memory card. Pressing <b>FORMAT CARD</b> deletes data stored on the memory card.
FREE RUN	activates the trigger condition that allows the next sweep to start as soon as possible after the last sweep.
FREQ DIAG	<i>HP 8591A, HP 8593A, HP 8594A, or HP 8595A only.</i> displays, in real-time, frequency diagnostic information for the LO section. This is a service diagnostic function and is for service use only.
FREQ DISC NORM OFF	<i>HP 8591A, HP 8593A, HP 8594A, or HP 8595A only.</i> indicates the status of the frequency discriminator as a function of LO span. This is a service diagnostic function and is for service use only.

### 3-40 Analyzer Functions

FREQ  
OFFSET

adds an offset value to the frequency readout to account for pre-analyzer frequency conversions. Offset entries are added to all frequency readouts including marker, start frequency, and stop frequency. Entering an offset does not affect the trace. Offsets are not added to the span. Frequency offsets are entered using the numeric keypad.

When a frequency offset is entered, its value is displayed on the bottom of the screen (as opposed to reference level offsets, which are displayed on the left side of the screen). To eliminate an offset, press **FREQ OFFSET**, 0 **ENTER**. Pressing **PRESET** also sets the offset to zero.

**FREQUENCY**

activates the center-frequency or start-frequency function and accesses the menu that has the frequency functions. The center frequency or start frequency value appears below the graticule on the screen.

Although the spectrum analyzer allows entry of frequencies greater than the specified frequency range, using frequencies greater than the frequency span of the analyzer is not recommended.

**Note**



When changing both the center frequency and the span, change the frequency first since the span can be limited by the frequency value.

**FULL  
SPAN**

changes the analyzer span to full span.

*For an HP 8592B, HP 8593A, and HP 8595A only:* span can be limited if harmonic bandlock (**BND LOCK ON OFF**) is set to on.

#### Full Span Frequency Range

Model	Frequency Range
HP 8590B	9 kHz to 1.8 GHz
HP 8591A	9 kHz to 1.8 GHz
HP 8592B	2.75 GHz to 22 GHz *
HP 8593A	2.75 GHz to 22 GHz *
HP 8594A	9 kHz to 2.9 GHz
HP 8595A	9 kHz to 6.5 GHz *

\* Harmonic band lock is set to OFF.

GATE CTL  
EDGE LVL

*Option 105 only.*

determines if the gate is enabled on the edge of the trigger input or on the level of the input signal. If the gate control is set to EDGE, the edge of the input signal triggers the timer for the gate delay. When the gate control is set to LVL, the gate follows the positive level of the signal connected to GATE TRIGGER INPUT. When the gate control is set to level, the functions of gate delay and gate length no longer apply and therefore, the **GATE DELAY**, **GATE LENGTH**, and **EDGE PDL POS NEG** softkeys are blanked.

GATE DELAY	<i>Option 105 only.</i> sets the duration of the delay before gating. The gate delay can be set from 1 $\mu$ s to 65.535 ms.
GATE LENGTH	<i>Option 105 only.</i> sets the duration of the gate. The gate length can be set from 1 $\mu$ s to 65.535 ms.
GATE MENU	<i>Option 105 only.</i> accesses the softkey functions used for Option 105, the time-gated spectrum analyzer capability. Press <b>GATE MENU</b> to access <b>GATE DELAY</b> , <b>GATE LENGTH</b> , <b>GATE CTL EDGE LVL</b> , or <b>EDGE POL POS NEG</b> .
GATE ON OFF	<i>Option 105 only.</i> turns on or off the gate for Option 105, the time-gated spectrum analyzer capability.
GHIJKL	accesses the softkey menu used for selecting screen title or prefix characters G through L.
GND REF DETECTOR	displays the output of the analog-ground reference produced on the A16 Processor/Video assembly. This is a service diagnostic function and is for service use only.
GRAT ON OFF	turns the screen graticule on and off. This is helpful when alternative graphics are drawn on the screen through a remote controller and during plotting, when a graticule is not required.
INPUT Z 50 75	sets the input impedance for voltage-to-power conversions. The impedance you select is for computational purposes only, since the actual impedance of 50 $\Omega$ (except for Option 001) is set by internal hardware. The preset value can be changed by using a service function. Select the computational input impedance by pressing <b>INPUT Z 50 75</b> or by entering 75 or 50 using the numeric keypad.
INTRNL CRD	<i>Requires Option 003 for an HP 8590B or HP 8592B.</i> selects between analyzer memory and the memory card for the save and recall functions.
INTRNL ->STATE	recalls the saved analyzer state from the selected state register. Recalling a state from the analyzer memory displays the time and date when the state data was stored. To recall a state, press <b>INTRNL -&gt;STATE</b> and use the numeric keypad to enter a state register number (valid state register numbers are 1 through 9). State register 9 contains a previous state; state register 0 contains the current state.
INTRNL ->TRACE	accesses a softkey menu that allows you to either select the trace in which the trace data is to be recalled (trace A, trace B, or trace C), recall the current limit-line tables, or recall amplitude correction factors. When recalling a trace, select the trace in which the trace data is to be recalled, enter the trace register number, and press <b>ENTER</b> . When recalling limit-line tables or amplitude correction factors, press <b>LIMIT LINES</b> or <b>AMPLTUD COR FACT</b> , respectively, enter the trace register number, and press <b>ENTER</b> . Valid trace register numbers are 0 through the maximum register number. The maximum

### 3-42 Analyzer Functions

register number is the number displayed after **MAX REG # =** during a save or recall operation. If a screen title is present, it is recalled with the trace data (but not with the limit-line table or the amplitude-correction factors). If the screen title does not exceed 34 characters, the time and date when the data was stored will also be displayed.

**INVALID SAVEREG** is displayed if data has not been stored in the trace register. **LAST SPAN** changes the analyzer's frequency span to the previous span setting.

**LAST SPAN**

**LIMIT  
LINES**

when accessed by **MEAS/USER**, accesses the limit-line menus. When accessed by **SAVE**, pressing **LIMIT LINES** stores the current limit-line tables in analyzer memory or on the memory card. When accessed by **RECALL**, pressing **LIMIT LINES** recalls limit-line tables from analyzer memory or the memory card. See "To Save a Limit-Line Table or Amplitude Correction Factors" or "To Recall Limit-Line Tables or Amplitude Correction Factors" in Chapter 1 for more information.

**LIMITS  
FIX REL**

allows you to choose fixed or relative type of limit lines. The fixed (**FIX**) type uses the current limit-line as a reference for fixed frequency and amplitude values. The relative (**REL**) setting causes the current limit-line value to be relative to the displayed center frequency and reference-level amplitude values. For example, if a limit line is specified as fixed, entering a limit-line segment with a frequency coordinate of 300 MHz displays the limit-line segment at 300 MHz. If the same limit-line table is specified as relative, it is displayed relative to the analyzer's center frequency and reference level. If the center frequency is at 1.2 GHz, a relative limit-line segment with a frequency coordinate of 300 MHz will display the limit-line segment at 1.5 GHz. If the amplitude component of the relative limit-line segment is -10 dB, then -10 dB is added to the reference level value to obtain the amplitude of the given component (reference level offset included).

**RELATIVE** is displayed in the limit-line table when the limit-line type is relative; **FIXED** is displayed when limit-line type is fixed.

A limit line entered as fixed may be changed to relative, and one entered as relative may be changed to fixed. When changing between fixed and relative limit-lines, the frequency and amplitude values in the limit-line table change so that the limit line remains in the same position for the current frequency and amplitude settings of the spectrum analyzer.

**LIMITEST  
ON OFF**

turns the limit-line testing and display of the limit lines on and off. When limit-line testing is enabled, every measurement sweep of trace A is compared to the limit lines. If trace A is at or within the bounds of the limit lines, **LIMIT PASS** is displayed. If trace A is out of the limit-line boundaries, **LIMIT FAIL** is displayed.

**LINE**

activates the trigger condition that allows the next sweep to be synchronized with the next cycle of the line voltage.

**LOAD  
FILE**

loads a file from the memory card into analyzer memory. When the memory card is selected, pressing any of the catalog softkeys (**CATALOG ALL**, **CATALOG STATES**, **CATALOG TRACES**, **CATALOG PREFIX**, **CATALOG DLP**, **CATALOG AMP CORR**, or **CATALOG LMT LINE**) accesses **LOAD FILE**. When

cataloging analyzer memory using CATALOG REGISTER , press LOAD FILE to recall the contents of a state or trace register into analyzer memory. To use the LOAD FILE function, use the step keys to view sections of the directory, use the knob to select a file then press LOAD FILE . Trace data is loaded into trace B. See the softkey descriptions for CATALOG CARD and CATALOG REGISTER .

---

**Note**

Use of the LOAD FILE softkey is not recommended for recalling limit-line tables or amplitude-correction factors stored in analyzer memory.

---

**(LOCAL)**

Pressing **CONFIG** after the analyzer has been placed in the remote mode places the analyzer in the local mode and enables front-panel control. During remote operation, R appears in the lower-right corner of the screen indicating remote and talk. A T or L may appear during remote operation, indicating talk or listen. Pressing the **CONFIG** key removes the R symbol in the lower-right corner.

**MAIN  
COIL DR**

displays the output produced by the main-coil driver on the A7 Analog Interface assembly. This is a service diagnostic function and is for service use only.

**MAIN  
SPAN**

displays the main-coil-span signal, MC\_SPAN, from the span dividers on the A7 Analog Interface assembly. This is a service diagnostic function and is for service use only.

**MAN QP  
AT MKR**

performs a subset of the routine executed by pressing **AUTO QP AT MKR** and then displays a menu of quasi-peak softkeys. See the HP 8591A or HP 8593A Option 103 Manual Supplement for more information.

**MAN TRK  
ADJUST**

*Option 010 or 011 only.*

allows the user to adjust the frequency of the tracking-generator oscillator manually using the step keys or knob. The tracking adjust is tuned to maximize the amplitude of the trace.

Tracking error occurs when the output frequency of the tracking generator is not exactly matched to the input frequency of the spectrum analyzer. The resulting mixing product from the spectrum analyzer input mixer is not at the center of the IF bandwidth. Any tracking errors may be compensated for through manual adjustments of the tracking generator's oscillator, or through an automatic tracking routine, which is initiated by pressing **TRACKING PEAK**.

**MARKER  
AMPTD**

keeps the active marker at the requested amplitude on the screen.

Once activated, the marker remains at the amplitude selected by the step keys, knob, or numeric keypad, even if the signal frequency is changed. The marker will be placed at the leftmost signal at that amplitude. If no signal exists at that amplitude, it will be placed above the highest signal amplitude (or below the lowest trace element if it is below all trace elements). When marker delta is active in addition to marker amplitude, the behavior of the active marker is useful for measuring signal bandwidths. For example,



place a marker 20 dB below the peak of a signal, press **MARKER DELTA** ,  
**MARKER AMPTD** . The marker readout shows the 20 dB bandwidth.

**MARKER**  
**->CF** changes the analyzer settings so that the frequency at the marker becomes the center frequency.

**MARKER**  
**->CF STEP** changes the center-frequency step size to match the value of the active marker. Press **FREQUENCY** , **CF STEP AUTO MAN** to view the step size. If marker delta is active, the step size will be set to the frequency difference between the markers.

**MARKER**  
**DELTA** activates a second marker at the position of the first marker. (If no marker is present, two markers appear at the center of the display.) The amplitude and frequency of the first marker is fixed, and the second marker is under your control. Annotation in the active function block and in the upper-right corner of the screen indicates the frequency and amplitude differences between the two markers.

---

**Note** If there are already two markers when **MARKER DELTA** is pressed, the nonactive marker disappears, the active marker becomes a reference marker, and the delta marker becomes the active marker.

**MARKER**  
**NORMAL** activates a single frequency marker at the center frequency on the active trace if an on-screen marker is not already displayed. If there is an on-screen marker before the **MARKER NORMAL** function is enabled, a frequency marker is enabled at the position of the first marker. Use the data controls to position the marker. Annotation in the active function block and in the upper-right corner indicates the frequency and amplitude of the marker. The marker stays on the trace at the horizontal screen position where it was left unless **SIGNAL TRACK** , **MARKER AMPTD** , or a "marker to" softkey function (such as **MARKER ->CF** , **MARKER ->REF LVL** , **MARKER ->CF STEP** , **MKR Δ -> SPAN** , or **MINIMUM -> MARKER** ) is selected. Pressing **MARKER NORMAL** turns off the marker-delta function.

**MARKER**  
**NORM PK** *For Option 103 only.* provides a function similar to a normal marker when making quasi-peak measurements. When **NORM** is selected, the marker can be moved anywhere on the trace; when **PK** is selected, the marker is placed on the highest on-screen signal peak after each sweep.

**MARKER**  
**->REF LVL** changes the analyzer settings so that the amplitude at the active marker becomes the reference level.

**MARKERS**  
**OFF** turns off all markers, including markers used for signal track and demodulation (demodulation is only available with Option 102 or 103). Marker annotation is removed.

**MAX**  
**HOLD A** updates each trace point of trace A with the maximum level detected at each point during successive sweeps.

**MAX**  
**HOLD B** updates each trace point of trace B with the maximum level detected at each point during successive sweeps.

MAX MXR  
LEVEL

lets you change the maximum input mixer level in 10 dB steps from -10 dBm to -100 dBm. The mixer level is equal to the reference level minus the attenuator setting. As the reference level changes, the input attenuator setting is changed to keep the power levels less than the selected level at the input mixer. Pressing **PRESET** resets the maximum input mixer level to -10 dBm.

**MEAS/USER**

switches between the menu containing **USER MENU(S)**, **FFT MEAS**, **3dB POINTS**, **6 dB POINTS**, **LIMIT LINES**, **MORE 1 of 3**, and **AMP COR** and the user menu. If no keys have been defined in the user menu, **NO USER MENU** is displayed. See the *HP 8590 Series Spectrum Analyzer Programming Manual* for more information about defining keys in the user menu.

MIN  
HOLD C

updates each trace point of trace C with the minimum level detected at each point during successive sweeps.

MINIMUM  
->MARKER

moves the active marker to the minimum detected amplitude value.

MIXER  
BIAS DAC

*HP 8592B, HP 8593A, or HP 8595A only.*  
displays the output of the mixer-bias DAC from the first-converter driver on the A7 Analog Interface assembly. This is a service diagnostic function and is for service use only.

MKNOISE  
ON OFF

reads out the average noise level, referenced to a 1 Hz noise power bandwidth, at the marker position. If no marker is present, a marker appears at the center of the screen. The root-mean-square noise level, normalized to a 1 Hz noise power bandwidth, is read out. The sample detector is activated.

MKPAUSE  
ON OFF

stops the analyzer sweep at the marker position for the duration of the dwell time.

The dwell time can be set from 2 milliseconds to 100 seconds.

**MKR**

accesses the marker function softkeys. Markers are diamond-shaped characters that identify points of traces and allow the traces to be manipulated and controlled on the screen. During manual operation, two markers may appear on the display simultaneously; only one can be controlled at a time. The marker that is controlled is called the "active" marker. Pressing **MKR** activates the **MARKER NORMAL** softkey.

**MKR ->**

(read "marker to") calls up the softkeys used for the transfer of marker information directly into other functions.

MKR CNT  
ON OFF

*HP 8591A, HP 8593A, HP 8594A, and HP 8595A only.*  
turns on the marker counter when ON is underlined. If no marker is active before **MKR CNT ON OFF** is pressed, a marker is activated at center screen. Press **MKR CNT ON OFF** (so that OFF is underlined), to turn the marker counter off. Press **CNT RES AUTO MAN** to change the marker counter resolution to an uncoupled value. The ratio of the resolution bandwidth to span must be greater than 0.01 for the marker function to work properly. **DECR SPAN** appears on screen if the bandwidth to span ratio is less than 0.01.

**MKR Δ**  
**->SPAN** sets the start and stop frequencies to the values of the delta markers. The start and stop frequencies will not be set if the delta marker is off.

**MNOPQR** accesses the softkey menu for selecting screen title or prefix characters M through R.

**MODE** changes the softkey menus for the spectrum-analyzer mode and other modes of operation when **SPECTRUM ANALYZER** (located under **PRESET**) and **PRESET SPECTRUM** are selected, respectively. Consult the documentation accompanying the HP 85711A Cable Television Measurements Card, the HP 85712A EMI Diagnostics Measurements Card, or the HP 85713A Digital Radio Measurements Card for information about these other modes of operation.

**NEW LIMIT** clears the limit-line table. Pressing **NEW LIMIT** displays the message: **IF YOU ARE SURE, PRESS KEY AGAIN TO PURGE DATA.** Press **NEW LIMIT** a second time to clear the limit-line table. Press **SAVE LIMIT** to save the limit-line table, then press **NEW LIMIT** to clear the limit-line table.

**NEXT PEAK** places the marker on the next highest peak. The signal peak must exceed the threshold value. (Also see the **PEAK EXCURSN** and **THRESHLD ON OFF** softkey descriptions.)

**NEXT PK LEFT** moves the marker to the next peak to the left of the current marker. The signal peak must exceed the threshold value. If there is no peak to the left, the marker will not move. (Also see the **PEAK EXCURSN** and **THRESHLD ON OFF** softkey descriptions.)

**NEXT PK RIGHT** moves the marker to the next peak to the right of the current marker. The signal peak must exceed the threshold value. If there is no peak to the right, the marker will not move. (Also see the **PEAK EXCURSN** and **THRESHLD ON OFF** softkey descriptions.)

**NORMLIZE ON OFF** subtracts trace B from trace A and adds the result to the display line. The result is displayed in trace A. The trace data is normalized with respect to the display line even if the value of the display line is changed. This function is executed on all subsequent sweeps until it is turned off. A minus sign (–) appears between the trace A status and the trace B status in the screen annotation while the function is active. To turn off the normalize function, press **NORMLIZE ON OFF** so that **OFF** is underlined.

The normalize function is useful for applying correction data to a trace. For example, store a measurement sweep of the response of a system in trace B. Trace A can be used to measure the response of the system after a device is added. Set **NORMLIZE ON OFF** to **ON** to subtract the system response from the response of the device under test, to characterize the response of a device under test.

**NORMLIZE POSITION** displays the display line and makes the display line function active. The trace data is normalized with respect to the display line even if the value of the display line is changed.

NO USER  
MENU(S)

is displayed if key number 1 has not been defined by the user. Key number 1 can be defined by remote programming commands (KEYCMD or KEYDEF).

NTSC

*Options 101 and 102 or Option 301 only.*

allows you to trigger on the NTSC video format. Pressing **NTSC** alters the TV line number that the analyzer triggers on internally; the line number displayed when **TV LINE #** is pressed does not change. Pressing **NTSC** changes the video modulation to negative; set **TV SYNC NEG POS** so that POS is underlined if positive video modulation is required.

PAINTJET  
PRINTER

*Option 021 or 023 only.*

selects a color print (for use with an HP PaintJet printer only). The traces are displayed in orange (trace A), blue (trace B), and red (trace C). The graticule, screen annotation, and user information are displayed in black.

PAL

*Options 101 and 102 or Option 301 only.*

allows you to trigger on the PAL video formats. Pressing **PAL** alters the TV line number that the analyzer triggers on internally; the line number displayed when **TV LINE #** is pressed does not change. Pressing **PAL** changes the video modulation to negative; set **TV SYNC NEG POS** so that POS is underlined if positive video modulation is required.

PAL-M

*Options 101 and 102 or Option 301 only.*

allows you to trigger on the PAL-M video formats. **PAL-M** alters the TV line number the analyzer triggers on internally; the line number displayed by **TV LINE #** does not change. **PAL-M** changes the video modulation to negative; use **TV SYNC NEG POS** (POS) if positive video modulation is required.

PEAK  
EXCURSN

sets the minimum amplitude variation of signals that the marker can identify as a peak. If a value of 10 dB is selected, the marker moves only to peaks that rise and fall more than 10 dB above the threshold line (or the noise floor of the display). Pressing **PRESET** or turning on power resets the excursion to 6 dB, and the threshold to 70 dB below the reference level.

---

## Note



When a peak has a lump on its skirt that is the peak-excursion value above the threshold, the lump is considered a peak in its own right only if it has a peak excursion drop on both sides. Two peaks that are so close that only a valley divides them are not differentiated if the valley is not the peak-excursion value deep.

When the peak excursion value is less than 6 dB, the marker-peaking functions may not recognize signals less than 6 dB above the noise floor. To correct this, when measuring signals near the noise floor, the excursion value can be reduced even further. To prevent the marker from identifying noise as signals, reduce the noise floor variance to a value less than the peak-excursion value by reducing the video bandwidth or by using video averaging.

PEAK MENU	accesses the same softkeys that are available when <b>PEAK SEARCH</b> is pressed (see the key description for <b>PEAK SEARCH</b> below). Pressing PEAK MENU instead of <b>PEAK SEARCH</b> lets you use the peak-search functions without initiating a new peak search.
<b>PEAK SEARCH</b>	automatically places a marker on the highest amplitude of a trace, displays the marker's amplitude and frequency, and accesses <b>MARKER -&gt; CF</b> , <b>MARKER DELTA</b> , <b>NEXT PEAK</b> , <b>NEXT PK RIGHT</b> , <b>NEXT PK LEFT</b> , and <b>PEAK EXCURSN</b> .
PEAK SEARCH	<i>HP 8592B only.</i> automatically places a marker on the highest amplitude of a trace and displays the marker's amplitude and frequency. This softkey can be accessed by pressing <b>AUX CTRL</b> , then <b>CORRECT TO COMB</b> .
PK-PK MEAS	finds and displays the frequency and amplitude differences between the highest and lowest signals. Pressing PK-PK MEAS performs the routine similar to pressing the following keys: <b>PEAK SEARCH</b> , <b>MARKER DELTA</b> , and then moves the second marker to the lowest detected signal.
PLOT CONFIG	<i>Option 021 or 023 only.</i> accesses the menu used to address the plotter and to select plotter options.
PLOTTER ADDRESS	<i>Option 021 or 023 only.</i> changes the HP-IB address of the plotter. The plotter address is set to 5 by pressing <b>DEFAULT CONFIG</b> .
PLT LOC	<i>Option 021 or 023 only.</i> selects the position of the plotter output. The highlighted portion of the softkey label indicates where the plot is to be output on the page. This softkey function appears only if two or four plots per page are selected when <b>PLTS/PG 1 2 4</b> is pressed.
PLTS/PG 1 2 4	<i>Option 021 or 023 only.</i> allows you to plot a full-page, half-page, or quarter-page output. Selecting two plots per page requires a plotter that has the rotate command (RO). The plotter will be set to a full-page output by pressing <b>DEFAULT CONFIG</b> .
POINT	specifies a limit value for one coordinate point, so that a POINT segment specifies a limit value for a single frequency. For an upper limit line, a POINT segment is indicated by a line drawn vertically from the coordinate point to a point off the top of screen. For a lower limit line, a POINT segment is indicated by a line drawn vertically from the coordinate point to a point off the bottom of screen. The POINT segment type is generally used as the last segment in the limit-line table. However, if the last segment in the table is not of the POINT segment type, an implicit point is automatically added at the right-hand side of the screen. If a visible POINT segment at the right-hand edge of the display is not desired, add an explicit last-point segment to the limit-line table that is higher in frequency than the stop frequency.
POWER ON IP LAST	determines the state of the spectrum analyzer when the spectrum analyzer is powered on. If the POWER ON function is set to IP, the state of the spectrum analyzer is the same as it is after <b>PRESET</b> is pressed, when the

analyzer is powered on. If the POWER ON function is set to LAST, then the state that the spectrum analyzer was left in when it was powered off is recalled.

The setting (IP or LAST) of the POWER ON function is not changed by pressing **PRESET**. Use the **POWER ON IP LAST** softkey function to change the setting of which analyzer state is recalled at power on.

Limit lines are not recalled when the spectrum analyzer is powered up.

---

**Note**

If you have a downloadable program or “personality” installed in analyzer memory, the following changes apply to the operation of the POWER ON function: When using a downloadable program or personality, the last state of the personality is not recalled. We recommend that, if you are using a downloadable program or personality, you set **POWER ON IP LAST** to IP. If **POWER ON IP LAST** is set to LAST, you must press **PRESET** whenever you power on the analyzer.

---

**PRESEL**

*HP 8592B, HP 8593A, or HP 8595A only.*

**DAC**

peaks the YTF preselector by allowing the user to manually adjust the YTF fine-tune DAC. This is a service diagnostic function and is for service use only.

**PRESEL**

*HP 8592B, HP 8593A, and HP 8595A only.*

**DEFAULT**

enables default preselector data for bands 1 through 4, to allow maximum frequency response without peaking the preselector. The CAL YTF routine should be performed before pressing **PRESEL DEFAULT**.

**PRESEL**

*HP 8592B, HP 8593A, and HP 8595A only.*

**PEAK**

optimally centers the preselector on a given signal for the most accurate measurement of amplitude. The maximum response found for the frequency at the marker determines the future adjustment values that will be provided to the preselector.

**PRESET**

provides a convenient starting point for making most measurements. Pressing **PRESET** displays softkeys used for accessing the operating modes available for your analyzer. (See the key description for **MODE** for more information.) See Table 3-6 and Table 3-7 for the conditions established by pressing **PRESET**.

The instrument preset function performs a processor test, but does not affect CAL data. Pressing **PRESET** clears both the input and output buffers, but does not clear trace B. The amplitude values of trace C are set to the reference level. Amplitude-correction factors are turned off. Limit-line testing is turned off, but the limit-line tables remain in analyzer memory. The status byte is set to 0. Instrument preset affects all operating modes. (See the key description for **MODE** for more information about other operating modes.) Pressing **PRESET** erases all “on time” functions—ONCYCLE, ONDELAY, ONEOS, ONMKR, ONSRQ, ONSWP, ONTIME, and TRMATH. These are remote programming commands. See the *HP 8590 Series Spectrum Analyzer Programming Manual* for more information.

**Note**

Turning the spectrum analyzer on performs an instrument preset. Turning on the analyzer also fetches CAL data; completes a processor test; clears trace B, trace C, and both the input and output buffers; turns off amplitude correction factors; turns off limit-line testing; and sets the status byte to 0. The last state of the analyzer (before it was switched off) is recalled, unless LAST has been set by the POWER ON function.

**Table 3-6. Common Preset Conditions**

A - B -> A	off
Amplitude correction factors	off
Amplitude units	default values
Annotation and graticule	on
Attenuation	10 dB (auto-coupled)
Center frequency	Refer to Table 3-7 below.
CF step size	10% of span
Coupled functions	all set to AUTO
Mass storage device (card or internal)	INTRNL
Detector	positive peak
Display line level	2.5 graticule divisions below reference level, display off
Frequency offset	0 Hz
Limit-line testing	off
LIMIHI and LIMILO	cleared
Log scale	10 dB/division
Marker counter *	off
Marker counter resolution *	auto-coupled
Markers	off
Mixer level	-10 dBm
Operating mode	spectrum analyzer
Preselector peak †	reset
Reference level	0 dBm in power-on units
Reference level offset	0
Reference level position	8
Resolution bandwidth	3 MHz (auto-coupled)
* HP 8591A, HP 8593A, HP 8594A, and HP 8595A only.	
† HP 8592B, HP 8593A, and HP 8595A only.	

Table 3-6. Common Preset Conditions (continued)

Span	Refer to Table 3-7 below.
SRQ mask	octal 50
Start Frequency	Refer to Table 3-7 below.
Stop Frequency	Refer to Table 3-7 below.
State registers 1—8	unaffected
Sweep	continuous
Threshold level	one graticule above baseline, display off
Title	cleared
Trace A	clear-write
Trace B	store-blank
Trace C	store-blank, at reference level
Trace registers	unaffected
Trigger	free run
VBR/RBW ratio	0.3
Video averaging	off
Video bandwidth	1 MHz (auto-coupled)
* HP 8591A, HP 8593A, HP 8594A, and HP 8595A only.	
† HP 8592B, HP 8593A, and HP 8595A only.	

Table 3-7. Model Specific Preset Conditions

Model	Center Frequency	Span	Start Frequency	Stop Frequency	Sweep Time
HP 8590B	900 MHz	1.8 GHz	0 Hz	1.8 GHz	20 ms (auto-coupled)
HP 8591A	900 MHz	1.8 GHz	0 Hz	1.8 GHz	20 ms (auto-coupled)
HP 8592B	12.38 GHz	19.25 GHz	2.75 GHz	22 GHz	385 ms, full span (auto-coupled)
HP 8593A	12.38 GHz	19.25 GHz	2.75 GHz	22 GHz	385 ms, full span (auto-coupled)
HP 8594A	1.450 GHz	2.9 GHz	0 Hz	2.9 GHz	58 ms (auto-coupled)
HP 8595A	3.25 GHz	6.5 GHz	0 Hz	6.5 GHz	130 ms (auto-coupled)

**PRESET SPECTRUM**

allows the spectrum-analyzer mode only to be preset; the PRESET SPECTRUM function will not affect the other operating modes. Table 3-8 lists the conditions affected by the PRESET SPECTRUM function.

In addition, pressing **PRESET SPECTRUM** erases user-generated graphics and blanks the active-function block that is on the analyzer screen. If the analyzer is an HP 8592B, HP 8593A, or HP 8595A, the harmonic band lock is also turned off.

**3-52 Analyzer Functions**



Pressing PRESET SPECTRUM disposes of ONEOS, ONSWP, and TRMATH. These are remote programming commands; see the *HP 8590 Series Spectrum Analyzer Programming Manual* for more information.

**Table 3-8. Preset Spectrum Conditions for All Models**

A - B -> A	off
Annotation and graticule	on
Attenuation	coupled
Center frequency	Refer to Table 3-7 above.
Center frequency step size	10% of span
Coupled functions	all set to AUTO
Coupling *	AC
Detector	positive peak
Display line	off
Frequency offset	0 Hz
Harmonic lock	off
Limit-line testing	off
Log scale	10 dB/div
Marker counter †	off
Marker counter resolution *	2 kHz (auto-coupled)
Markers	off
Measure	SA (spectrum analyzer)
On end-of-sweep command (ONEOS)	cleared
On-sweep command (ONSWP)	cleared
Reference level	0 dBm in power-on units
Reference level offset	0 dB
Reference level position	8
Resolution bandwidth	3 MHz (coupled)
Span	Refer to Table 3-7 above.
Start frequency	Refer to Table 3-7 above.
Stop frequency	Refer to Table 3-7 above.
State registers 1—8	unaffected
Sweep	continuous
* HP 8594A and HP 8595A only.	
† HP 8591A, HP 8593A, HP 8594A, and HP 8595A only.	

**Table 3-8.  
Preset Spectrum Conditions for All Models (continued)**

Sweep time	Refer to Table 3-7 above. (coupled)
Threshold	off
Trace A	clear-write
Trace B	store-blank
Trace C	store-blank
Trace math command (TRMATH)	cleared
Trace registers	unaffected
Trigger	free
Video averaging	off
Video bandwidth	1 MHz (coupled)
Video bandwidth to resolution bandwidth ratio	0.3

**PRINT  
CONFIG**

*Option 021 or 023 only.*  
accesses the softkey functions that are used to address the printer, select a black and white print or a color print (a color print requires an HP PaintJet printer), and reset the printer.

**PRINTER  
ADDRESS**

*Option 021 and 023 only.*  
allows you to change the HP-IB address of the printer. The printer address is set to 1 by pressing **DEFAULT CONFIG**.

**PRINTER  
SETUP**

*Option 021 or 023 only.*  
resets the printer, sets the printer to 60 lines per page, and skips line perforations. This function enables you to obtain up to three printouts per page. The printer paper should be at the top of the form before using this function. The **PRINTER SETUP** function may not work with printers that are not recommended (see "Accessories" in Chapter 1 of the Installation and Verification Manual for your instrument for recommended printers).

**PRT MENU  
ON OFF**

*Option 021 or 023 only.*  
allows the softkey labels to be printed along with the analyzer display. This function operates in conjunction when using the **COPY** key in a print configuration. The **PRT MENU** function is set to ON when **DEFAULT CONFIG** is pressed.

**PURGE  
AMP COR**

clears the current amplitude-correction factors table. Pressing **PURGE AMP COR** displays the message: IF YOU ARE SURE, PRESS KEY AGAIN TO PURGE DATA. Pressing **PURGE AMP COR** a second time clears the amplitude-correction data. Press **SAVE AMP COR** to save amplitude-correction factors, and then press **PURGE AMP COR** to clear the current amplitude-correction factors table.

**PURGE  
LIMITS**

clears the current limit-line table from analyzer memory. Pressing **PURGE LIMITS** displays the message: IF YOU ARE SURE, PRESS KEY AGAIN TO PURGE DATA. Press **PURGE LIMITS** again if you wish to clear the current limit-line table. Press **SAVE LIMIT** to save the current limit-line table, and then press **NEW LIMIT** or **PURGE LIMITS** to clear the current limit-line table.

PWR SWP  
ON OFF

*Option 010 or 011 only.*

activates (ON) or deactivates (OFF) the power-sweep function, which sweeps the output power of the tracking generator over the selected power-sweep range. The value of the power-sweep range is displayed in the active-function block when PWR SWP ON OFF is turned on. The available power-sweep range is a function of the source attenuator setting: For power sweeps, press SRC ATN MAN AUTO until MAN is underlined so the spectrum analyzer is manually set (decoupled).

For a given source attenuation setting, the maximum specified power-sweep range is given by the following:

Power Sweep Range = (-15 dBm minus source attenuation setting) to (0 dBm minus source attenuation setting).

For example, if the source attenuation setting is 20 dB, the maximum power sweep range is from -35 dBm (-15 dBm - 20 dB) to -20 dBm (0 dBm - 20 dB). The starting power level is the source power setting. The ending power level is the sum of the source power setting plus the source power sweep setting. Source power sweep may be set as high as 20 dB, but performance is specified only up to 15 dB.

The output power of the tracking generator is swept according to the sweep rate of the spectrum analyzer. The output power is always swept from the source power setting to a higher power setting (negative source power sweep values are not allowed). Refer to Table 1-2 in the Installation and Verification Manual for your instrument for more information regarding source power and source attenuation relationships.

Power-sweep measurements are particularly useful in making gain compression measurements or output power versus frequency measurements.

QP X10  
ON OFF

*For Option 103 only.*

amplifies the video signal ten times (20 dB) in order to make an accurate measurement of a low quasi-peak signal. See the HP 8591A or HP 8593A Option 103 Manual Supplement for more information.

QP DET  
ON OFF

*Option 103 only.*

turns the quasi-peak detector on and off. This is a service diagnostic function and is for service use only. See either the service documentation or the HP 8591A or HP 8593A Option 103 Manual Supplement for more information.

QP GAIN  
ON OFF

*Option 103 only.*

amplifies the video signal ten times (20 dB). This is a service diagnostic function and is for service use only.

QPD  
OFFSET

*Option 103 only.*

sets the offset of the quasi-peak detector. This is a service diagnostic function and is for service use only.

QPD RST  
ON OFF

*Option 103 only.*

discharges and resets the quasi-peak detector. This is a service diagnostic function and is for service use only.

QUASI  
PEAK

*For Option 103 only.*

accesses the menu of quasi-peak softkey functions and, if there is not an on-screen marker, places a marker on the highest on-screen signal. See the HP 8591A or HP 8593A Option 103 Manual Supplement for more information.

**RECALL**

accesses softkey menus that allow you to recall data from the memory card or analyzer memory. When INTRNL is selected, states, traces, limit-line tables, amplitude-correction factors can be recalled from analyzer memory. When CRD is selected, states, traces, limit-line tables, and amplitude-correction factors, and downloadable programs can be recalled from the memory card.

In addition, pressing **RECALL** accesses the cataloging functions used to catalog the saved data that is in analyzer memory or on the memory card.

**RECALL  
AMP COR**

recalls an amplitude-correction factors table from the current mass-storage device (analyzer memory or memory card). To verify the current mass storage device, press **RECALL AMP COR**. If MAX REG # appears on the analyzer display, the current mass storage device is analyzer memory. If PREFIX= is displayed, the memory card is the mass storage device. Press **SAVE** or **RECALL**, **INTRNL CRD** to change the current mass storage device. To recall an amplitude-correction factors table, enter the register number that the table was previously saved under, then press **ENTER**. When recalling an

amplitude-correction factors table from the memory card, it may be necessary to change the current prefix to the prefix with which the table was stored. Press **CHANGE PREFIX** to change the current prefix. When saved in analyzer memory, the register number is restricted to the range between 0 and the number  $x$  indicated by MAX REG# =  $x$ . The screen title is not recalled with the amplitude-correction factors table.

**RECALL  
LIMIT**

recalls limit-line tables from the current mass-storage device (analyzer memory or memory card). To verify the current mass-storage device, press **RECALL LIMIT**. If MAX REG # appears on the analyzer display, the current mass-storage device is analyzer memory. If PREFIX= is displayed, the memory card is the mass-storage device. Press **SAVE** or **RECALL**, **INTRNL CRD** to change the current mass-storage device. To recall a limit line, enter the register number that the limit-line tables was saved under, then press **ENTER**. When recalling a limit line from the memory card, it may be necessary to change the current prefix to the prefix with which the limit line was stored. Press **CHANGE PREFIX** to change the current prefix. When saved in analyzer memory, the register number is restricted to the range between 0 and the number  $x$  indicated by MAX REG# =  $x$ . The screen title is not recalled with the limit-line tables.

**REF LVL**

allows the reference level to be changed. This function is activated when **AMPLITUDE** is pressed. The reference level is the amplitude power or voltage represented by the top graticule line on the screen. Changing the value of the reference level changes the absolute amplitude level (in dBm) of the top graticule line.

REF LVL  
OFFSET

adds an offset value to the displayed reference level. Offsets are entered by using the number/units keypad. Entering an offset does not affect the trace or the attenuation value. Reference-level offsets are used when gain or loss occurs between a device under test and the spectrum-analyzer input. Thus, the signal level measured by the analyzer is the level at the input of an external amplitude-conversion device. When an amplitude offset is entered, its value is displayed on the left side of the screen (as opposed to frequency offsets which are displayed at the bottom of the screen). To eliminate an offset, press REF LVL OFFSET, 0 **(-dBm)** or **(+dBm)**. Pressing **(PRESET)** also sets the offset to zero. Reference-level offsets are entered using the numeric keypad. See also the **EXT PREAMP** softkey description.

RES BW  
AUTO MAN

changes the analyzer's 3 dB IF bandwidth to either 1 kHz, 3 kHz, 10 kHz, 30 kHz, 100 kHz, 300 kHz, 1 MHz, 3 MHz, or 5 MHz. As the resolution bandwidth is decreased, the sweep time is increased to maintain amplitude calibration. To indicate that it is not coupled, a "#" mark appears next to RES BW on the screen. To recouple the RES BW, press RES BW AUTO MAN so that AUTO is underlined. The resolution bandwidth can be changed using the step keys, the knob, or the numeric keypad.

RETURN

*For Option 103 only.*

returns the analyzer to the settings that were present when **MAN QP AT MKR** was pressed, displays the quasi-peak amplitude value and the quasi-peak marker if **ACCEPT QP DATA** was pressed, and returns to the previous quasi-peak softkey menu. See the HP 8591A or HP 8593A Option 103 Manual Supplement for more information.

RPG  
TITLE

provides additional characters for the CHANGE TITLE function. Pressing **RPG TITLE** provides lowercase letters, numbers, Greek letters, and punctuation symbols. When **RPG TITLE** is pressed, a character table appears on the screen. To select a character, turn the knob to position the cursor under the desired character and press the **(ENTER)** key. The step keys move the cursor between rows. When all characters have been entered, press **(HOLD)**. All other analyzer functions are inaccessible until **(HOLD)** is pressed.

**(SAVE)**

accesses softkey menus that allow you to store state data, trace data, limit-line tables, and amplitude-correction factors in analyzer memory. The **SAVE** function also allows you to save state data, trace data, limit-line tables, amplitude-correction factors, and program data on the memory card. In addition, pressing **(SAVE)** accesses the softkey menus used to catalog the saved data in analyzer memory or on the memory card. To save to or catalog from analyzer memory, press **INTRNL CRD** so that **INTRNL** is underlined. To save to or catalog from the memory card, press **INTRNL CRD** so that **CRD** is underlined.

Saving state data saves the analyzer settings, but not the trace data. Saving trace data saves both the trace data and the state data. Programs (also called downloadable programs or DLPs), can only be saved to or recalled from the memory card.

States and traces are saved in analyzer memory even if the instrument is turned off or **PRESET** is pressed. Eight spectrum-analyzer-memory state registers and many trace registers are available for the user.

**SAVE  
AMP COR**

saves the current amplitude-correction factors table to the current mass-storage device (analyzer memory or memory card). To verify the current mass storage device, press **SAVE AMP COR**. If **MAX REG #** appears on the analyzer display, the current mass storage device is analyzer memory. If **PREFIX=** is displayed, the memory card is the mass storage device. Press **SAVE** or **RECALL**, **INTRNL CRD** to change the current mass storage device. Press **SAVE AMP COR**, enter a register number, then press **ENTER** to save the current amplitude-correction factors table in analyzer memory or on the memory card. When saved on the memory card, amplitude-correction factors tables are stored with "a\_", the prefix, and the register number entered. When saved in analyzer memory, the register number is saved in a trace register. Trace register values are restricted to a range between 0 and the number  $x$  indicated by **MAX REG# = x**.

**SAVE  
LIMIT**

saves the current limit-line tables in the current mass-storage device (analyzer memory or memory card). To verify the current mass-storage device, press **SAVE LIMIT**. If **MAX REG #** appears on the analyzer display, the current mass-storage device is analyzer memory. If **PREFIX=** is displayed, the memory card is the mass-storage device. Press **SAVE** or **RECALL**, **INTRNL CRD** to change the current mass-storage device. Press **SAVE LIMIT**, enter a register number, then press **ENTER** to save the current limit-line table in analyzer memory or on the memory card. When saved on the memory card, limit-line tables are stored with "l\_", the prefix, and the register number entered. When saved in analyzer memory, the register number is saved in a trace register. Trace-register values are restricted to a range between 0 and the number  $x$  indicated by **MAX REG # = x**.

**SAV LOCK  
ON OFF**

locks all the current internal state and trace registers against further data storage, when **ON** is underlined. With the state and trace memory locked, the **STATE ->INTRNL** and **TRACE ->INTRNL** softkey functions are no longer accessible; the **MEM LOCKED** softkey function is displayed instead. Pressing **DEFAULT CONFIG** or **PRESET** sets **SAV LOCK ON OFF** to **OFF**.

---

**Note**



When **SAV LOCK ON OFF** is set to **ON**, none of the state registers can be overwritten, including state register nine. The analyzer automatically updates state register nine with the last state unless the **SAVE LOCK** function is on.

---

**SCALE  
LOG LIN**

scales the vertical graticule divisions in logarithmic units when **LOG** is underlined. When the **SCALE LOG LIN** function is the active function, the logarithmic units per division can be changed. Values may range from 0.1 to 20 dB per division. When **LIN** is underlined, the vertical scale is in linear mode. The reference-level value is set to the top of the screen and the bottom graticule becomes zero volts. (Each division of the graticule is one-eighth of the reference level in volts.)

Pressing SCALE LOG LIN always sets the units specified for the current amplitude scale. Pressing **PRESET** or powering on the analyzer sets the default units.

**SECAM-L** *Options 101 and 102 or Option 301 only.*  
triggers on the SECAM-L video formats. Pressing **SECAM-L** alters the TV line number that the analyzer triggers on internally; the line number displayed when **TV LINE #** does not change. Pressing **SECAM-L** changes the video modulation to positive; set **TV SYNC NEG POS** to **NEG** if negative video modulation is required.

**SELECT AMPLITUD** allows you to enter either the amplitude value for the displayed (upper or lower) limit-line segment or the amplitude value for the current amplitude-correction point. Enter the amplitude value for the frequency by using the data keys. Change an amplitude value by using the step keys or the knob. Press **BK SP** to correct errors.

**SELECT DLT AMPL** allows you to enter the delta amplitude value. The middle amplitude value and the delta amplitude value create an upper and lower limit-line segment. Enter the delta amplitude value for the frequency by using the knob or data keys. Press

**BK SP** to correct errors. The default value is 0.

**SELECT FREQ** allows you to enter the frequency value for a limit-line segment or the frequency value for an amplitude-correction point. Enter the frequency value for the frequency by using the data keys. Change the frequency value by using the step keys or the knob. Press **BK SP** to correct errors.

A frequency coordinate must always be specified for either limit lines or amplitude-correction factors.

---

**Note**  For limit-line tables, there can be only one entry per frequency. Entering two segments with the same frequency in the same limit-line table is not allowed.

Limit-line data is sorted in frequency order in the limit-line table. The sorting occurs after you have entered the frequency and at least one amplitude value.

---

**Note**  For amplitude-correction factors, only two entries with the same frequency are valid. More points with the same frequency in the same amplitude-correction factors table are ignored. Only the first and last points of a series with the same frequency values are used; the middle points are ignored.

Amplitude-correction data is sorted in the table by frequency. The sorting occurs immediately after you have entered the frequency value via the front-panel.

---

**SELECT LWR AMPL** allows you to enter the amplitude value for the lower limit-line segment. Enter the amplitude value for the frequency by using the knob or data keys. Press **BK SP** to correct errors.

**SELECT MID AMPL** allows you to enter the middle amplitude value. The middle amplitude value and the delta amplitude value create upper and lower limit-line segments.

Enter the amplitude value for the frequency by using the knob or data keys. Press **(BK SP)** to correct errors.

**SELECT POINT**

allows you to create or edit an amplitude-correction factors data point. Enter the point number to be created or edited by using the data keys, then press **(ENTER)**. Press **(BK SP)** to correct errors.

**SELECT PREFIX**

allows you to select an already existing prefix of a cataloged file and changes the current prefix to this selected prefix. This provides a convenient method for saving and recalling data to and from the memory card and for cataloging by the prefix. Use either the knob or step keys to select the file.

**SELECT SEGMENT**

allows you to create or edit a limit-line segment. Limit lines are created by entering frequency and amplitude values into a limit-line table. The frequency and amplitude values specify a coordinate point from which a limit-line segment is drawn. The coordinate point is the lowest frequency point of the line segment. Limit lines are constructed from left to right. To select a segment, press **SELECT SEGMENT**, enter the segment number you wish to specify, then press a units key.

Up to 20 segments can be specified per limit-line table.

**SELECT TYPE**

accesses the softkey menu used to select the limit-line type of line. Press **FLAT** to select a flat line, press **SLOPE** to select a sloped line, or press **POINT** to select a point.

**SELECT UPR AMPL**

allows you to enter the amplitude value for the upper limit-line segment. Enter the amplitude value for the frequency by using the knob or data keys. Press **(BK SP)** to correct errors.

**SERVICE CAL**

accesses several service calibration functions. The service calibration functions are designed for service use only. More detailed descriptions of the service functions are available in the service documentation. Service documentation can be obtained by ordering Option 915 through your HP Sales and Service office. For a listing of all available service calibration functions, refer to "Service Functions" at the beginning of this chapter.

**SERVICE DIAG**

accesses several service diagnostic functions. The service diagnostic functions are designed for service use only. More detailed descriptions of the service diagnostic functions are available in the service documentation. Service documentation can be obtained by ordering Option 915 through your HP Sales and Service office. For a listing of all available service diagnostic functions, refer to "Service Functions" at the beginning of this chapter.

**SET ATTN ERROR**

sets the calibration attenuator-error factors (this is not the same as the input attenuator). This is a service calibration function and is for service use only.

**SET DATE**

allows you to set the date of the real-time clock. Enter the date in the YYMMDD format using the number keypad and press **(ENTER)**. Valid year (YY) values are 00 through 99. Valid month (MM) values are from 01 to 12, and valid day values are from 01 to 31.

**SET TIME**

allows you to set the time of the real-time clock. Enter the time in 24 hour, HHMMSS format, using the number keypad and pressing **(ENTER)**. Valid hour (HH) values are from 00 to 23. Valid minute (MM) and second (SS) values are from 00 to 59.

### 3-60 Analyzer Functions



SETPLL OUTDAC	<i>HP 8591A, HP 8593A, HP 8594A, or HP 8595A only.</i> allows the sampling-oscillator frequency to be set manually. This is a service diagnostic function and is for service use only.
<b>SGL SWP</b>	changes the sweep control to single sweep if the analyzer is in the continuous sweep mode. It sets up a sweep for the trigger conditions.
SHOW OPTIONS	displays the number and description of the options installed in your analyzer, the instrument model number of the analyzer, and the last five digits of the analyzer's serial number. Pressing <b>SHOW OPTIONS</b> changes the softkey label to <b>EXIT SHOW</b> . Press <b>EXIT SHOW</b> to erase the SHOW OPTIONS function information.  Pressing <b>SHOW OPTIONS</b> does not display the option number or description of Option 026.
<b>SIGNAL TRACK</b>	moves the signal that is nearest to the active marker to the center of the screen and fixes the signal there. MKR-TRK or CNTR-TRK appears in the upper-right corner of the display.  Pressing <b>SIGNAL TRACK</b> , <b>PRESET</b> , <b>MARKER NORMAL</b> , or <b>MARKERS OFF</b> turns off the signal-track function.  When signal track is on and the span is reduced, an automatic zoom is performed: the span is reduced in steps so that the signal remains at the center of the screen. If the span is zero, signal track cannot be activated.
SLOPE	draws a straight line between the coordinate point of the current segment and the coordinate point of the next segment, producing limit-line values for all frequencies between the two points.
<b>SPAN</b> or <b>SPAN</b>	activates the SPAN function and accesses the frequency-span functions. Pressing <b>SPAN</b> changes the frequency range symmetrically about the center frequency. The frequency-span readout describes the total displayed frequency range; to determine frequency span per horizontal graticule division, divide the frequency span by 10.
SPAN ZOOM	finds the highest signal peak on-screen (if an on-screen marker is not present), places a marker on it, turns on the signal-track function, and activates the span function. Pressing <b>SPAN ZOOM</b> performs the routine similar to pressing the following keys: <b>PEAK SEARCH</b> , <b>SIGNAL TRACK</b> , and <b>SPAN</b> .
SPEAKER ON OFF	<i>Option 102 or 103 or Option 301 only.</i> turns the internal speaker on and off. The volume from the speaker is controlled by the front-panel volume control knob and <b>FM GAIN</b> (when using FM demodulation). There is no output from the speaker unless demodulation is turned on. Pressing <b>PRESET</b> sets <b>SPEAKER ON OFF</b> to ON.
SPECTRUM ANALYZER	sets the analyzer to the spectrum analyzer operating mode and accesses the <b>PRESET SPECTRUM</b> softkey function.

SQUELCH

*Option 102 or 103 or Option 301 only.*

adjusts the squelch level. The squelch level mutes weak signals and passes strong signals. The squelch level affects the audio output only. If the internal speaker is on, audio signals are not output unless the signal strength exceeds the squelch threshold. The squelch level does not affect the rear-panel AUX VIDEO OUT signal. Squelch level is indicated on-screen by the unitless numbers 0 to 100, with 0 being minimum squelch threshold (all signals are passed), and 100 being maximum squelch threshold (no signals are passed). The default squelch value is 0.

SRC ATN  
MAN AUTO

*HP 8591A with Option 010 or 011 only.*

allows you to select between automatic and manual adjustment of the tracking generator's switching attenuator. It can be manually adjusted from 0 to 60 dB in 10 dB steps. When auto-coupled, the SRC ATN function automatically adjusts the attenuator to yield the source amplitude level specified by the SRC PWR ON OFF softkey function. Set SRC ATN MAN AUTO so that MAN is underlined (decoupled) for power sweeps greater than 10 dB.

SRC PWR  
OFFSET

*Option 010 or 011 only.*

offsets the displayed power of the tracking generator (SRC). Offset values may range from -100 dB to +100 dB.

Using the source-power-offset capability of the tracking generator allows you to take system losses or gains into account, thereby displaying the actual power delivered to the device under test.

SRC PWR  
ON OFF

*Option 010 or 011 only.*

activates (ON) or deactivates (OFF) the output power of the tracking generator (SRC). The power level can then be adjusted using the data keys, step keys, or knob. The specified output power level is -75 to 0 dBm (50 $\Omega$ ), and -27.2 dBmV to +42.8 dBmV (75 $\Omega$ ), with 0.1 dB resolution.

SRC PWR  
STP SIZE

*Option 010 or 011 only.*

allows the user to set the step size of the source-power level, source-power offset, and power-sweep range functions. The step size may be values from -32.7 dB to 32.7 dB. The default setting is one vertical scale division.

START  
FREQ

sets the frequency at the left side of the graticule. The left and right sides of the graticule correspond to the start and stop frequencies. When these frequencies are activated, their values are displayed below the graticule in place of center frequency and span.

STATE  
->CARD

*Requires Option 003 for the HP 8590B or HP 8592B.*

saves the current analyzer state on the memory card. To save the current state, press STATE -> CARD, use the numeric keypad to enter a number, and press ENTER. If you want the file name of the stored data to contain a prefix, press CHANGE PREFIX to enter a prefix before storing the data. If the state data was stored using a prefix, the file name for the state data consists of s(prefix)-(register number). If no prefix was specified, the file name is s-(register number).

STATE  
->INTRNL

saves the current analyzer state in the selected state register. To save the current state, press STATE -> INTRNL, and use the numeric keypad to enter a state register number (valid state register numbers are 1 through 8).

### 3-62 Analyzer Functions

STOP FREQ	sets the frequency at the right side of the graticule. The left and right sides of the graticule correspond to the start and stop frequencies. When these frequencies are activated, their values are displayed below the graticule in place of center frequency and span.
STP GAIN ZERO	disables the two 20 dB step-gain amplifiers on the A12 Amplitude Control assembly. This is a service diagnostic function and is for service use only.
STUVWX	accesses the softkey menu used for selecting screen title or prefix characters S through X.
(SWEEP)	accesses the sweep-time menu and accesses the sweep-time softkey functions: SWP TIME AUTO MAN and <u>SWEEP CONT SGL</u> .
SWEEP CONT SGL	switches the analyzer between the continuous-sweep mode and the single-sweep mode. If the analyzer is in single-sweep mode, SGL is underlined. Press (SGL SWP) to enable a sweep when in single-sweep mode. When continuous-sweep mode is in use, one sweep follows another as soon as it is triggered. Pressing (PRESET), turning the power on, and pressing PRESET SPECTRUM all select continuous sweep.
SWEEP RAMP	displays the RAMP signal from the sweep-ramp generator that is located on the A7 Analog Interface assembly. This is a service diagnostic function and is for service use only.
SWEEP TIME DAC	displays the output of the sweep-time DAC (SWP_DAC) from the sweep-ramp generator that is on the A7 Analog Interface assembly. This is a service diagnostic function and is for service use only.
SWP CPLG SR SA	<i>Option 010 or 011 only.</i> selects stimulus-response (SR) or spectrum-analyzer (SA) auto-coupled sweep time. In stimulus-response mode, auto-coupled sweep times are usually much faster for swept-response measurements. Stimulus-response auto-coupled sweep times are typically valid in stimulus-response measurements when the system's frequency span is less than 20 times the bandwidth of the device under test.
SWP TIME AUTO MAN	selects the length of time in which the analyzer sweeps the displayed frequency span. In all non-zero frequency spans, the sweep time varies from 20 milliseconds to 100 seconds. In zero frequency span, the fastest sweep time is 15 milliseconds. Reducing the sweep time increases the rate of sweeps. The sweep time can be changed using the step keys, the knob, or the numeric keypad.  <i>For Option 101 only:</i> Option 101 provides sweep times from 20 $\mu$ s to 100 seconds in zero span. Fast zero span sweeps are digitized.

THRESHLD ON OFF	sets a lower boundary to the active trace. The threshold line “clips” signals that appear below the line when this function is on. The boundary is defined in amplitude units that correspond to its vertical position when compared to the reference level.  The value of the threshold appears in the active-function block and on the lower-left side of the screen. The threshold level does not influence the trace memory or marker position. The peaks found by the markers must be the peak-excursion value above the threshold level. The value of the threshold level can be changed using the step keys, the knob, or the numeric keypad. If a threshold is active, press <b>THRESHLD ON OFF</b> until OFF is selected to turn the threshold display off. The threshold value affects peak searching even when the THRESHLD function is set to off.
TIMEDATE	accesses the softkey menu used to set and display the real-time clock.
TIMEDATE ON OFF	turns the display of the real-time clock on and off. Pressing <b>DEFAULT CONFIG</b> sets <b>TIMEDATE ON OFF</b> to ON.
<b>TRACE</b>	accesses the trace softkeys that allow you to store and manipulate trace information. Each trace is comprised of a series of data points that form a register where amplitude information is stored. The analyzer updates the information for any active trace with each sweep. If two traces are being written to, they are updated on alternating sweeps. (Also see “Screen Annotation” in Chapter 1.)
TRACE A	sets up trace A for recalling previously-saved trace data into trace A or saving trace data from trace A.
TRACE A B C	selects the softkey menu used for trace A, trace B, or trace C functions. Press <b>TRACE A B C</b> until the letter of the desired trace is underlined.
TRACE B	sets up trace B for recalling previously-saved trace data into trace B or saving trace data from trace B.
TRACE C	sets up trace C for recalling previously-saved trace data into trace C or saving trace data from trace C.
TRACE ->CARD	begins the process used to save trace data, limit-line tables, or amplitude-correction factors on the memory card. Pressing <b>TRACE -&gt;CARD</b> accesses a softkey menu that allows you to select the trace to be saved (trace A, trace B, or trace C) and accesses the <b>LIMIT LINES</b> and <b>AMP COR</b> softkeys. To save a trace, press <b>TRACE A</b> , <b>TRACE B</b> , or <b>TRACE C</b> , use the numeric keypad to enter a trace register number, and press <b>ENTER</b> . To save limit-line tables or amplitude-correction factors, press <b>LIMIT LINES</b> or <b>AMP COR</b> , use the numeric keypad to enter a trace register number, and press <b>ENTER</b> . If you want the file name of the stored data to contain a prefix, press <b>CHANGE PREFIX</b> to enter a prefix before storing the data. If the trace data was stored using a prefix, the file name is t(prefix)-(register number). If no prefix was available, the data is stored under t-(register number). File names for limit-line tables and amplitude-correction factors are treated the same way as file names for trace data, except “l” or “a” is used instead of “t.” If a

screen title is present, it is saved with the trace data. The time and date that the data was stored is appended to the screen title.

When comparing a trace displayed in view mode with a recalled trace, it is possible to over-write the displayed trace by recalling the trace data. This can happen because the instrument state is saved (and recalled) with the trace data.

For example, if you save trace A when it is in clear-write mode, place trace A in view mode, then recall the trace data into trace B, trace B will be placed in view mode, but the trace mode of trace A is changed to clear-write mode (since the trace mode of trace A was clear-write when it was saved). To avoid this problem, we suggest that you change the trace mode of the traces to view or blank mode before saving the trace data.

**TRACE**  
**->INTRNL**

accesses a softkey menu that allows you to select the item to be stored in analyzer memory: the trace to be saved (trace A, trace B, or trace C), limit-line tables, or amplitude-correction factors. To save a trace, select the trace to be saved, enter the trace-register number and press **ENTER**. To save limit-line tables or amplitude-correction factors, press **LIMIT LINES** (to save limit-line tables) or **AMP COR** (to save amplitude-correction factors), enter the trace-register number and press **ENTER**. Valid trace-register numbers are 0 through the maximum register number. The maximum register number is the number  $x$  displayed after **MAX REG # = x** during a save or recall operation. If a screen title is present, it is saved with the trace data. The time and date that the trace was stored is appended to the screen title.

When comparing a trace displayed in view mode with a recalled trace, it is possible to over-write the displayed trace by recalling the trace data. This can happen because the instrument state is saved (and recalled) with the trace data. For example, if you save trace A when it is in clear-write mode, place trace A in view mode, then recall the trace data into trace B, trace B will be placed in view mode, but the trace mode of trace A is changed to clear-write mode (since the trace mode of trace A was clear-write when it was saved). To avoid this problem, we suggest that you change the trace mode of the traces to view or blank mode before saving the trace data.

**TRACK**  
**GEN**

*Option 010 or 011 only.*  
displays softkey menus for use with a built-in tracking generator.

**TRACKING**  
**PEAK**

*Option 010 or 011 only.*  
activates a routine that automatically adjusts the tracking adjustment to obtain the peak response of the tracking generator on the spectrum-analyzer display.

**Note**



For tracking peak to function properly, the tracking generator must be connected to the spectrum analyzer.

Before making a stimulus-response measurement, care must be taken to maximize the tracking adjustment of the tracking generator to ensure amplitude accuracy.

TRIG

accesses softkeys that let you select the sweep mode and trigger mode. (Also see "Screen Annotation" in Chapter 1.)

---

**Note**



With some delayed trigger functions (for example, external or TV triggering), the softkey menu is not updated until after the trigger has occurred.

---

TV LINE #	<i>Options 101 and 102 or Option 301 only.</i> selects the line number of the video picture field. The values allowed are 1 to 1012. <b>PRESET</b> sets the TV line number to 17.
TVSTND	<i>Options 101 and 102 or Option 301 only.</i> allows the analyzer to trigger on NTSC, PAL, PAL-M, or SECAM-L video formats.
TV SYNC NEG POS	<i>Options 101 and 102 or Option 301 only.</i> selects the polarity of the modulation of the video format. NTSC uses the negative or positive modulation video format. NTSC, PAL, PAL-M use negative modulation, SECAM-L uses positive modulation.
TV TRIG	<i>Options 101 and 102 or Option 301 only.</i> provides sweep triggering on the selected line of a video picture field and accesses the softkey menu used to select the line number of the video picture field and the type of video picture frame.  When <b>TV TRIG</b> is pressed, the trigger mode is changed to TV trigger, <b>TV LINE #</b> becomes the active function, and the softkey menu for changing the TV line numbers and video field trigger is accessed.  If the analyzer is in non-zero span, the resolution bandwidth is changed to 1 MHz, the frequency span is set to 0 Hz, the detector mode is changed to sample, the sweep time is changed to 100 $\mu$ s, the amplitude scale is changed to linear, a sweep is taken, and a marker is placed on the signal peak.
TV TRIG EVEN FLD	<i>Options 101 and 102 or Option 301 only.</i> selects an even video field of an interlaced video format to trigger on.
TV TRIG ODD FLD	<i>Options 101 and 102 or Option 301 only.</i> selects an odd video field of an interlaced video format to trigger on.
TV TRIG VERT INT	<i>Options 101 and 102 or Option 301 only.</i> selects a vertical interval to trigger on. Triggering occurs on the next pulse edge. If it triggers on an even field, triggering will not alternate between odd and even fields. If it triggers on an odd field, triggering will alternate between odd and even fields. The vertical interval is used for noninterlaced video formats.
USER MENU(S)	accesses a menu available for your use for user-defined programs and key functions.

**VBW/RBW RATIO** selects the ratio between the video and resolution bandwidths. If signal responses near the noise level are visually masked by the noise, the ratio can be set to less than 1 to smooth this noise. The knob and step keys change the ratio in a 1, 3, 10 sequence. Pressing **PRESET** and **AUTO ALL** sets the ratio to 0.300 X. The ratio can be changed using the step keys or the knob.

**VERIFY TIMEBASE** *HP 8591A, HP 8593A, HP 8594A, and HP 8595A only.* allows the time base digital-to-analog converter to be changed to verify that the time base performs to specification. Pressing **PRESET** resets the time base to its original value. A pass code is required to access this function.

---

**Note** The **VERIFY TIMEBASE** softkey function is not available for an HP 8590B, HP 8592B, or Option 004.



---

**VID AVG ON OFF** initiates a digital averaging routine that averages displayed signals and noise. This function does not affect the sweep time, bandwidth, or other analog characteristics of the analyzer. Annotation on the left side of the screen indicates the current number of sweeps averaged. The default number of sweeps is 100. Increasing the number of sweeps smooths the trace. To turn off the video averaging function, press **VID AVG ON OFF** so that OFF is underlined. The number of sweeps can be entered using the numeric keypad.

**VID BW AUTO MAN** changes the analyzer's post-detection filter from 30 Hz to 3 MHz in a 1, 3, 10 sequence.

As the video bandwidth is decreased, the sweep time is increased to maintain amplitude calibration. To indicate that it is not coupled, a “#” mark appears next to VBW displayed on the bottom of the analyzer screen. To couple the VID BW, press **VID BW AUTO MAN** so that AUTO is underlined.

---

**Note** Coupling the video bandwidth function also couples the video bandwidth to resolution bandwidth ratio function. If you want to auto-couple the video bandwidth to a nonstandard ratio, you must set the video bandwidth to auto-couple before setting the video-bandwidth/resolution-bandwidth ratio.



---

The video bandwidth can be changed by using the step keys, the knob, or the numeric keypad.

**VIDEO** activates the trigger condition that allows the next sweep to start if the detected RF envelope voltage rises to a level set by the display line. When **VIDEO** is pressed, the display line appears on the screen. For example, connect the CAL OUT signal to the analyzer input, change the trigger mode to video, and lower the display line. The analyzer triggers when the display line reaches the noise floor.

**VIEW A** holds and displays the amplitude data that is in the trace A register. The trace A register is not updated as the analyzer sweeps. If trace A is deactivated by pressing **STORE BLANK A**, the stored data can be retrieved by pressing **VIEW A**.

**VIEW B** holds and displays the amplitude data that is in the trace B register. The trace B register is not updated as the analyzer sweeps. If trace B is deactivated by pressing **STORE BLANK B**, the stored data can be retrieved by pressing **VIEW B**.

**VIEW C** holds and displays the amplitude data that is in the trace C register. The trace C register is not updated as the analyzer sweeps. If trace C is deactivated by pressing **STORE BLANK C**, the stored data can be retrieved by pressing **VIEW C**.

**Volts** changes the amplitude units to volts for the current setting (log or linear).

**Watts** changes the amplitude units to watts for the current setting (log or linear).

**X FINE TUNE DAC** displays the output of the YTO extra-fine-tune DAC (**FM\_TUNE**) that is on the A7 Analog Interface assembly. This is a service diagnostic function and is for service use only.

**YTF DRIVER** *HP 8592B, HP 8593A, or HP 8595A only.* displays the output of the sample-and-hold circuit in the YTF span divider and driver located on the A7 Analog Interface assembly. This is a service diagnostic function and is for service use only.

**YTF TUNE COARSE** *HP 8592B, HP 8593A, or HP 8595A only.* displays the output produced by the YTF coarse-tune DAC located on the A7 Analog Interface assembly. This is a service diagnostic function and is for service use only.

**YTF TUNE FINE** *HP 8592B, HP 8593A, or HP 8595A only.* displays the output produced by the YTF fine-tune DAC located on the A7 Analog Interface assembly. This is a service diagnostic function and is for service use only.

**YZ\_# SPC CLEAR** accesses the softkey menu used for selecting the characters Y, Z, underscore (-), #, space, or for clearing the screen title.

**ZERO SPAN** changes the frequency span to zero and turns off signal track if it is on.

blist>



#### 4. Key Menu



## Spectrum Analyzer Error Messages

---

The spectrum analyzer can generate various messages that appear on its screen during operation to indicate a problem.

There are three types of messages: hardware error messages (H), user-created error messages (U), and informational messages (M).

- Hardware error messages indicate the spectrum analyzer hardware is probably broken. Refer to Chapter 5 in the Installation and Verification Manual for more information.
- User-created error messages appear when the spectrum analyzer is used incorrectly. They are usually generated during remote operation (entering programming commands using either a controller or the external keyboard).
- Informational messages indicate the spectrum analyzer's progress within a specific procedure.

The messages are listed in alphabetical order on the following pages; each message is defined, and its type is indicated by an (H), (U), or (M).

### ADC-GND FAIL

Indicates a failure in the processor. (H)

### ADC-TIME FAIL

Indicates a failure in the processor. (H)

### ADC-2V FAIL

Indicates a failure in the processor. (H)

### CAL: \_ \_ \_

During the self-calibration routine, messages may appear on the display indicating the routine is progressing: SWEEP, FREQ, SPAN, AMPTD, FM GAIN + OFFSET, 3dB BW, ATTEN, LOG AMP, PEAKING, or YTF. FREQ UNCAL appears briefly during the CAL FREQ self-calibration routine. This is normal and does not indicate a problem. (M)

### CAL: DATA NOT STORED

#### CAL AMP NEEDED

The correction factors are corrupt and cannot be stored. Perform the CAL FREQ & AMPTD routine. This message also sets SRQ 110. (U) and (H)

### CAL: cannot execute CALAMP

enter: 0 dB PREAMP GAIN

The preamp gain should be set to 0 dB before the CAL AMPTD routine is performed. The preamp gain is set by using EXT PREAMP. This message also sets SRQ 110. (U) and (H)

### CAL: FM SPAN SENS FAIL

The spectrum analyzer could not set the span sensitivity of the FM coil. This message also sets SRQ 110. (H)

CAL: GAIN FAIL

Indicates the signal amplitude is too low during the CAL AMPTD routine. This message also sets SRQ 110. (H)

CAL: LOST COMB SIGNAL

Indicates the amplitude of the comb generator signal is insufficient to complete the CAL YTF self-calibration routine. Be sure to use a low-loss cable (SMA-to-Type N cable) to connect the comb generator output to the spectrum analyzer input before using CAL YTF. (U) and (H)

CAL: NO YTF IN 8590/1

The CAL YTF programming command is not available for the HP 8590B, HP 8591A, or HP 8594A. (U)

CAL: NO YTO AVAILABLE

The CAL DLY programming command is no longer necessary. (U)

CAL: PASSCODE NEEDED

Indicates that the function cannot be accessed without the pass code. (M)

CAL: RES BW AMPL FAIL

The relative insertion loss of the resolution bandwidth is incorrect. This message also sets SRQ 110. (H)

CAL SIGNAL NOT FOUND

Indicates the calibration signal (CAL OUT) cannot be found. Check that the CAL OUT and the spectrum analyzer input connectors are connected with an appropriate cable. If the calibration signal is connected to the spectrum analyzer input but cannot be found, press **FREQUENCY**, **-37**, **Hz** before performing the CAL FREQ or CAL FREQ & AMPTD self-calibration routines. This message also sets SRQ 110. (U) and (H)

CAL: SPAN SENS FAIL

The self-calibration span sensitivity routine failed. This message also sets SRQ 110. (H)

CAL: USING DEFAULT DATA

Indicates that the calibration data is corrupt and the default correction factors are being used. Interruption of the self-calibration routines or an error can cause this problem. (M)

COMB SIGNAL NOT FOUND

The comb signal cannot be found. Check that 100 MHz COMB OUT is connected to the spectrum analyzer input. The comb generator is available with the HP 8592B, HP 8593A, or HP 8595A only. (U) and (H)

COMMAND ERROR: \_ \_ \_

The specified programming command is not recognized by the spectrum analyzer. (U)

CONFLICT TABLE OVERFLOW

Indicates that too many two-letter compatible commands have been used. See the table containing a summary of compatible commands in the Programming Manual for information about substituting alternate commands for two-letter compatible commands. (U)

CONF TEST FAIL

Indicates that the confidence test failed. This message also sets SRQ 110. (H)

DECR SPAN

Indicates the resolution bandwidth to span ratio is too small to use the marker count function. Check the span and bandwidth settings. (U)

FAIL: \_ \_ \_

An error was discovered during the power-up check. The 4-digit by 10-digit code indicates the type of error. Error codes are described in the spectrum analyzer Service Manual. (H)

FREQ UNCAL

Indicates a YTO-tuning failure. This may occur when using default correction factors. Performing the CAL FREQ routine may eliminate the failure. It does not indicate a problem if the FREQ UNCAL message appears briefly during the CAL FREQ routine or when the frequency value is changed. (U) and (H)

INTRNL LOCKED

The spectrum analyzer's internal trace and state registers have been locked. To unlock the trace or state registers, press SAV LOCK ON OFF so that OFF is underlined. For remote operation, use PSTATE OFF. (U)

INVALID ACTDEF: \_ \_ \_

The specified ACTDEF name is not valid. See the ACTDEF programming command. (U)

INVALID AMPCOR: FREQ

For the AMPCOR command, the frequency data must be in increasing order. See the AMPCOR programming command. (U)

INVALID AUNITS: \_ \_ \_

The amplitude units are not valid. See the AUNITS programming command. (U)

INVALID BLOCK FORMAT: IF STATEMENT

An invalid block format appeared within the IF statement. (U)

INVALID CARD: DIRECTORY

Indicates the memory card has not been formatted. (U)

INVALID CARD: NO CARD

Indicates a memory card has not been inserted. (U)

INVALID CARD

Indicates one of the following conditions: a card reader is not installed, the memory card is write-protected, the memory card is a read-only card, or a memory card has not been inserted. This message can also occur if remote programming commands for the memory card capability are executed with an HP 8590B or HP 8592B that does not have an Option 003. (U)

INVALID CARD: TYPE

Indicates one of the following conditions: a card reader is not installed, the memory card is write-protected, the memory card is a read-only card, or a memory card has not been inserted. This message can also occur if remote programming commands for the memory card capability are executed with an HP 8590B or HP 8592B that does not have an Option 003. (U)

INVALID CHECKSUM: USTATE

The user-defined state does not follow the expected format. (U)

#### INVALID COMPARE OPERATOR

An IF/THEN or REPEAT/UNTIL routine is improperly constructed. Specifically, the IF or UNTIL operands are incorrect. (U)

#### INVALID ENTER FORMAT

The enter format is not valid. See the appropriate programming command description to determine the correct format. (U)

#### INVALID FILE: NO ROOM

Indicates that there is not enough available space on the memory card to store the data. (U)

#### INVALID FILENAME \_ \_ \_

Indicates the specified file name is invalid. A file name is invalid if it is omitted, the first letter of the file name is not alphabetic, or the specified file type does not match the type of file. See the SAVRCLW or STOR programming command for more information on file type. (U)

#### INVALID HP-IB ADDRESS/OPERATION

An HP-IB operation was aborted due to an incorrect address or invalid operation. Check that there is only one controller (the spectrum analyzer) connected to the printer. (U)

#### INVALID HP-IB OPERATION REN TRUE

The HP-IB operation is not allowed. (This is usually caused by trying to print or plot when a controller is on the interface bus.) (U)

#### INVALID ITEM:\_ \_ \_

Indicates an invalid parameter has been used in a programming command. (U)

#### INVALID KEYLBL: \_ \_ \_

Indicates that the specified key label contains too many characters. A key label is limited to 8 characters per label line. (U)

#### INVALID KEYNAME:\_ \_ \_

The specified key name is not allowed. (The key name may have conflicted with a spectrum analyzer programming command.) Use an underscore as the second character in the key name, or avoid beginning the key name with the following pairs of letters: LB, OA, OL, TA, TB, TR, MA, MF, TS, OT, and DR. (U)

#### INVALID OUTPUT FORMAT

The output format is not valid. See the appropriate programming command description to determine the correct format. (U)

#### INVALID REGISTER NUMBER

The specified trace register number is invalid. (U)

#### INVALID REPEAT MEM OVFL

Memory overflow occurred due to a REPEAT routine. This occurs if the repeat statements are too long. (U)

#### INVALID REPEAT NEST LEVEL

The nesting level in the REPEAT routine is improperly constructed. This can occur if too many REPEAT routines are nested. (U)

#### INVALID RS-232 ADDRESS/OPERATION

An RS-232 operation was aborted due to an incorrect address or invalid operation. (U)

INVALID SAVE REG

Data has not been saved in the specified state or trace register, or the data is corrupt. (U)

INVALID SCR MOVE

Indicates the spectrum analyzer's battery may have failed. See the spectrum analyzer's Service Manual for more information. (U)

INVALID STORE DEST: \_ \_ \_

The specified destination field is invalid. (U)

INVALID SYMTAB ENTRY: SYMTAB OVERFLOW

Indicates that there is a symbol table overflow. This message can occur if there are too many user-defined items (functions, variables, key definitions) or downloadable programs in spectrum analyzer memory. Use **DELETE FILE** or **DISPOSE USER MEM** to delete unnecessary items. This message can also occur when the processor board has failed. See the spectrum analyzer's Service Manual for more information. (U)

INVALID TRACE: \_ \_ \_

The specified trace is invalid. (U)

INVALID TRACE NAME: \_ \_ \_

The specified trace name is not allowed. Use an underscore as the second character in the trace name, or avoid beginning the trace name with the following pairs of letters: LB, OA, OL, TA, TB, TR, MA, MF, TS, OT, and DR. (U)

INVALID TRIGGER MODE: \_ \_ \_

The specified trigger mode is invalid. See the TM programming command. (U)

INVALID VALUE PARAMETER: \_ \_ \_

The specified value parameter is invalid. (U)

INVALID VARDEF: \_ \_ \_

The specified variable name is not allowed. Use an underscore as the second character in the variable label, or avoid beginning the variable label with the following pairs of letters: LB, OA, OL, TA, TB, TR, MA, MF, TS, OT, and DR. (U)

INVALID WINDOW TYPE: \_ \_ \_

The specified window is invalid. See the TWINDOW programming command. (U)

MEAS UNCAL

The measurement is uncalibrated. Check the sweep time, span, and bandwidth settings. (U)

NO CARD FOUND

Indicates that the memory card is not inserted. (U)

NO COUNTERLOCK AVAILABLE

The MKFC and MKFCR programming commands are available for the HP 8591A, HP 8593A, HP 8594A, or HP 8595A only. (U)

OVEN COLD

Indicates that the spectrum analyzer has been powered up for less than 5 minutes. (Option 004 only.) (M)

PARAMETER ERROR: \_ \_ \_

The specified parameter is not recognized by the spectrum analyzer. See the appropriate programming command description to determine the correct parameters. (U)

POS-PK FAIL

Indicates the positive-peak detector has failed. (H)

RES-BW SHAPE FAIL

Indicates the 3 dB bandwidth is not within specifications. (H)

REF UNLOCK

Indicates that the frequency reference is not locked to the external reference input. Check that the 10 MHz REF OUT connector is connected to the EXT REF IN connector, or that an external 10 MHz reference source is connect to the EXT REF IN connector (when using an external reference). (M) and (H)

RES-BW NOISE FAIL

Indicates the noise floor level is too high at the indicated bandwidth. (H)

SAMPLE FAIL

Indicates the sample detector has failed. (H)

SOFTKEY OVFL

Softkey nesting exceeds the maximum number of levels. (U)

SRQ \_ \_ \_

The specified service request is active. Service requests are a form of informational message and are explained in the Operation Manual for the spectrum analyzer. (M)

STEP GAIN/ATTEN FAIL

Indicates the step gain has failed. (H)

SYMTAB EMPTY

Indicates that the amount of memory that user-defined items (functions, variables, key definitions) or downloadable programs require has exceeded the available spectrum analyzer memory. If SYMTAB EMPTY appears, the items in the spectrum analyzer's user memory have been deleted. If this happens, you need to reload any user-defined items and downloadable programs back into spectrum analyzer memory, but make sure that there is enough available spectrum analyzer memory. If necessary, delete any unnecessary downloadable programs from spectrum analyzer memory before loading another downloadable program. The amount of spectrum analyzer memory used and the amount of spectrum analyzer memory available can be displayed by using `CATALOG INTRNL`. See `CATALOG INTRNL` in the Operating Manual for more information about displaying the amount of analyzer memory available. (U)

TABLE FULL

Indicates the upper or lower table of limit lines contains the maximum number of entries allowed. Additional entries to the table are ignored. (U)

TG SIGNAL NOT FOUND

Indicates the tracking generator output signal cannot be found. Check that the tracking generator output (RF OUT 50Ω or RF OUT 75Ω) is connected to the spectrum analyzer input connector with an appropriate cable. (U)

TG UNLVL

Indicates that the source power is set higher or lower than the spectrum analyzer can provide. See "Stimulus-Response Measurements" in the Operating Manual for more information.

## A-6 Spectrum Analyzer Error Messages



UNDF KEY

A softkey referred to is not recognized by the spectrum analyzer. (U)

VID-BW FAIL

Indicates the video bandwidths have failed. (H)

Appendix



## Key Menus

---

This chapter contains the key menu diagrams for the HP 8590 Series spectrum analyzers. There are three separate key menus in this chapter grouped as follows:

- The HP 8590B/8592B Key Menu.
- The HP 8591A/8593A Key Menu.
- The HP 8594A/8595A Key Menu.

Each key menu diagram is arranged alphabetically according to the front-panel key names.

---

**Note**

Some of the softkeys in the key menus are model or option specific and may not appear on your spectrum analyzer.

---

# HP 8590B/8592B KEY MENUS

## AMPLITUDE

REF LVL  
ATTEN, AUTO MAN  
SCALE, LOG LIN  
PRESEL, PEAK\*  
PRESEL, DEFAULT\*  
MORE, 1 of 2

MAX MXR, LEVEL  
AMPTD, UNITS  
EXT. PREAMP  
INPUT Z, 50 75  
REF LVL, OFFSET  
MORE, 2 of 2

dBm  
dBmV  
dBuV  
Volts  
Watts

## AUTO COUPLE

AUTO, ALL  
RES BW, AUTO MAN  
VID BW, AUTO MAN  
ATTEN, AUTO MAN  
SWP TIME, AUTO MAN  
CF STEP, AUTO MAN

## AUX CTRL

---  
TRACK, GEN†  
AUX CONN, CONTROL  
COMB GEN, ON OFF\*  
---  
CORRECT, TO COMB\*

SRC PWR, ON OFF†  
TRACKING, PEAK†  
MAN TRK, ADJUST†  
PWR SWP, ON OFF†  
---  
MORE, 1 of 2†

SRC PWR, STP SIZE†  
SRC PWR, OFFSET†  
ALC MTR, INT XTAL†||  
SWP CPLG, SR SAT†  
---  
MORE, 2 of 2†

PEAK, SEARCH\*  
NEXT PK, RIGHT\*  
NEXT PK, LEFT\*  
CLEAR OFFSET\*  
CONTINUE\*  
ABORT\*

CNTL A, 0 1  
CNTL B, 0 1  
CNTL C, 0 1  
CNTL D, 0 1  
---  
DISPLAY, CNTL 1

## BW

RES BW, AUTO MAN  
VID BW, AUTO MAN  
VBW/RBW, RATIO  
VID AVG, ON OFF  
9 kHz, EMI BW  
120 kHz, EMI BW

## CAL

CAL FREQ, & AMPTD  
CAL, FREQ  
CAL, AMPTD  
CAL, YTF\*  
CAL, STORE  
MORE, 1 of 3

CONF, TEST  
CAL, FETCH  
CORRECT, ON OFF  
CRT VERT, POSITION  
CRT HORZ, POSITION  
MORE, 2 of 3

SERVICE, CAL  
SERVICE, DIAG  
DEFAULT, CAL DATA  
CAL, TRK GEN†  
---  
MORE, 3 of 3

---  
EXECUTE, TITLE  
FLATNESS, DATA  
---  
CAL MXR\*  
SET ATTN, ERROR

DISPLAY, CAL DATA  
DACS  
STP GAIN, ZERO  
AUXA  
AUXB‡  
MORE 1

2v REF, DETECTOR  
GND REF, DETECTOR  
MAIN, COIL DR  
FM COIL, DRIVE  
FM SPAN  
MORE 2

MAIN, SPAN  
SWEEP, RAMP  
SWEEP, TIME DAC  
COARSE, TUNE DAC  
BINARY, SPAN§  
MORE 3

EDIT, FLATNESS  
---  
---  
---  
EXIT

FINE, TUNE DAC  
X FINE, TUNE DAC  
+10V REF, DETECTOR  
-10V REF, DETECTOR  
DROOP  
MORE 4

YTF TUNE, COARSE\*  
YTF TUNE, FINE\*  
YTF, DRIVER\*  
MIXER, BIAS DAC\*  
PRESEL, DAC#  
MORE 5

\* HP 8592B only.  
† Option 010 or 011 only  
‡ HP 8590B only.  
§ Changes to YTF, SPAN for the HP 8592B.  
|| Changes to ALC, INT EXT for the HP 8592B with Option 010.  
# Changes to ALC TEST for on HP 8590B with Option 010 or 011.

# HP 8590B/8592B KEY MENUS

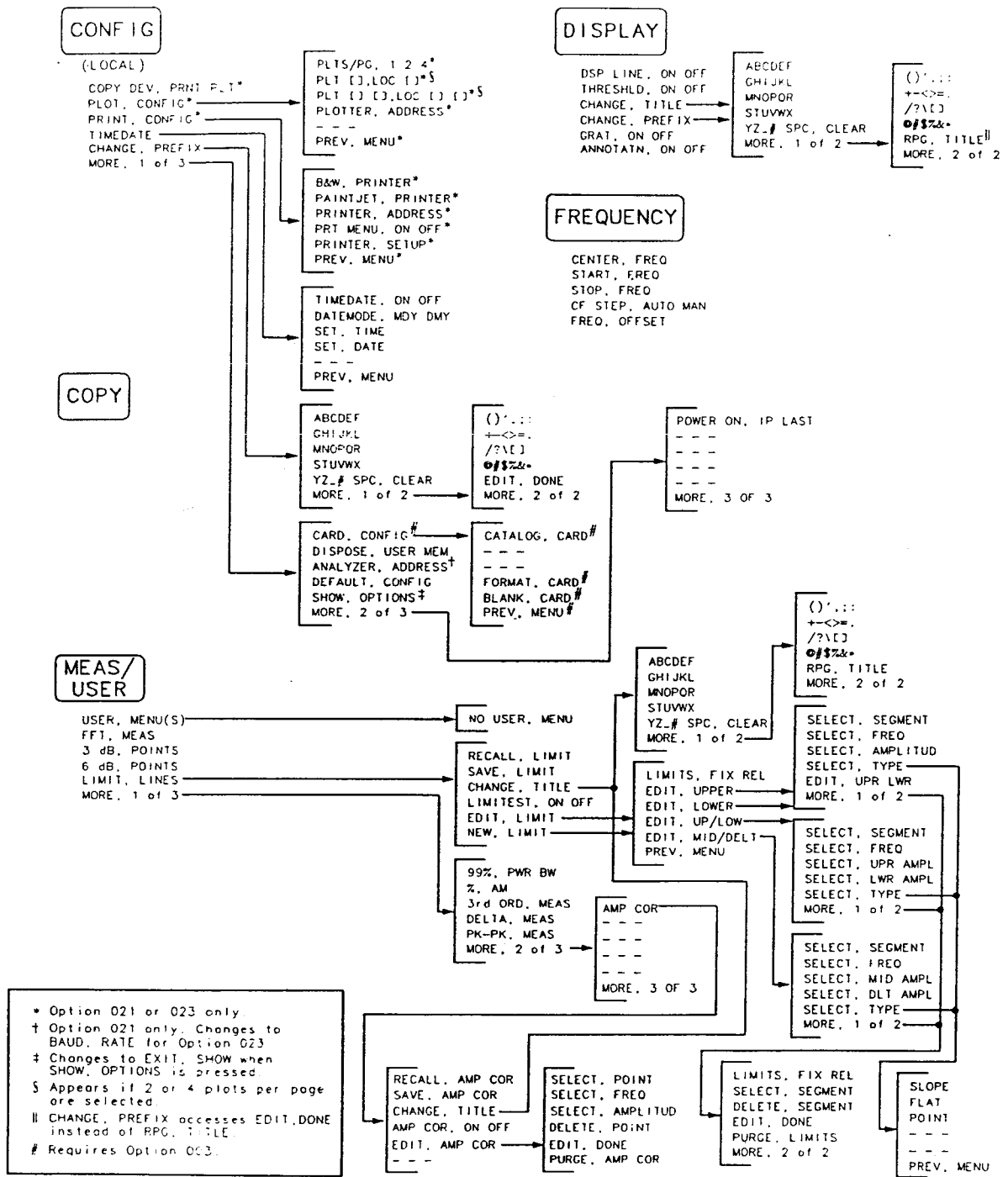

# HP 8590B/8592B KEY MENUS

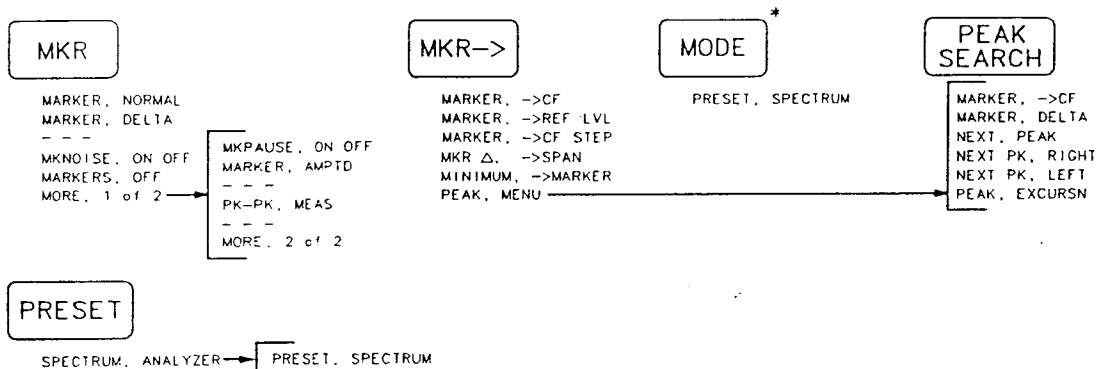

FOR RECALLING AND SAVING TO ANALYZER MEMORY:

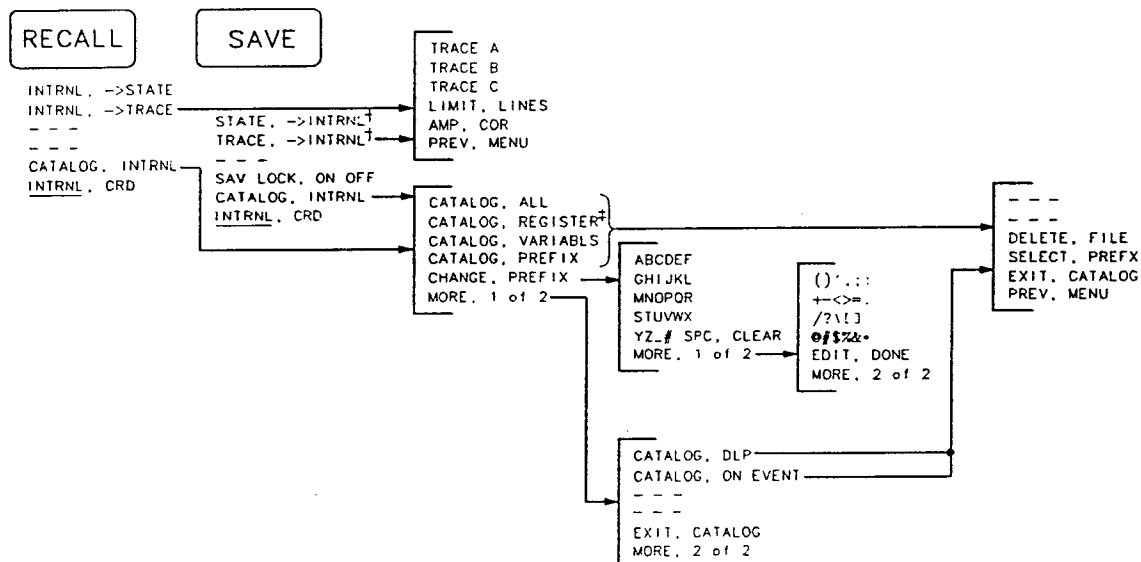

- \* Changes to the Preset menu.
- † Changes to MEM, LOCKED when SAV LOCK is ON.
- ‡ CATALOG, REGISTER accesses LOAD, FILE instead of DELETE, FILE.

# HP 8590B/8592B KEY MENUS

FOR RECALLING AND SAVING TO THE MEMORY CARD:  
(Requires Option 003)

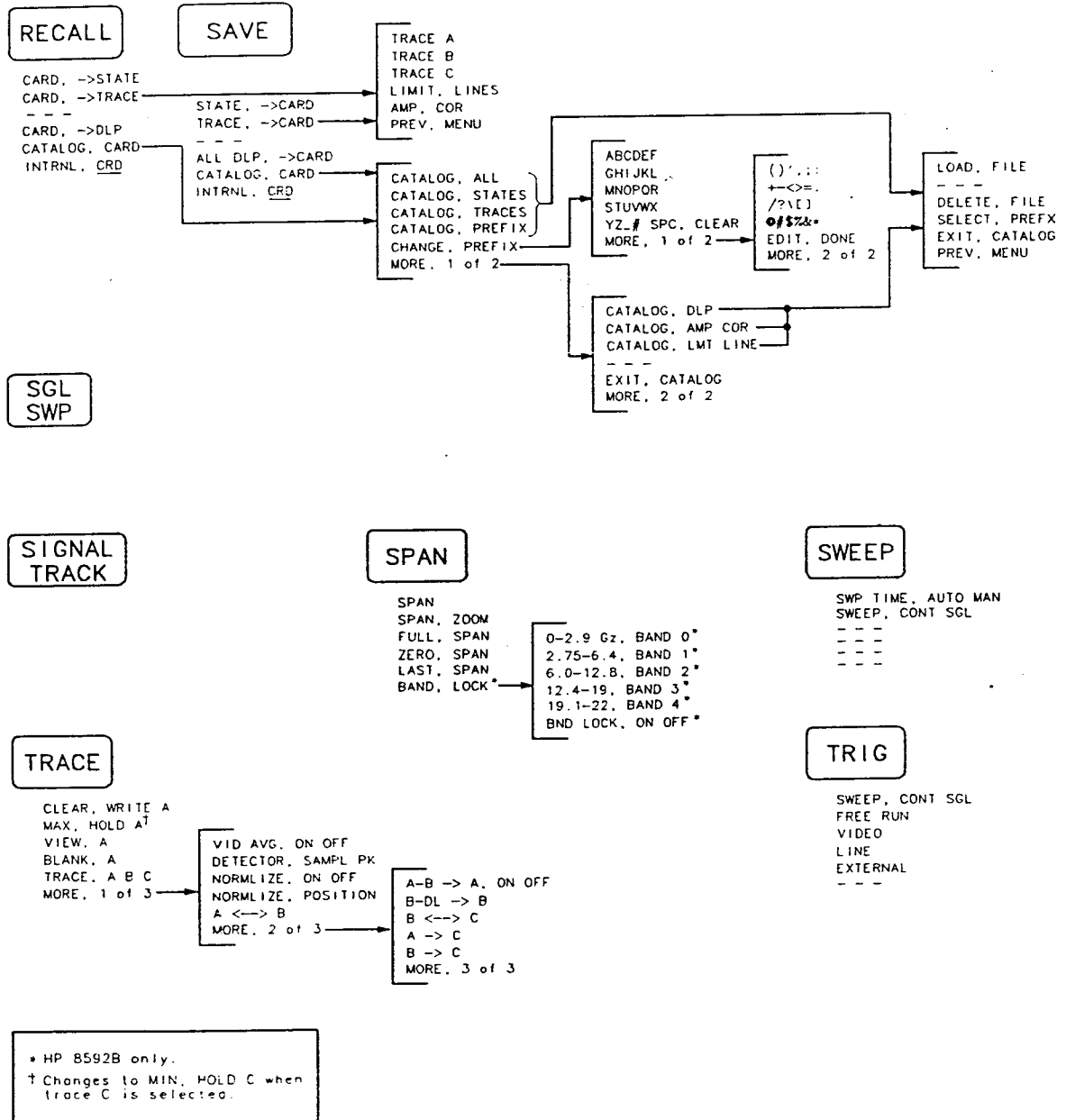

\* HP 8592B only.  
† Changes to MIN, HOLD C when trace C is selected.



# HP 8591A/8593A KEY MENUS

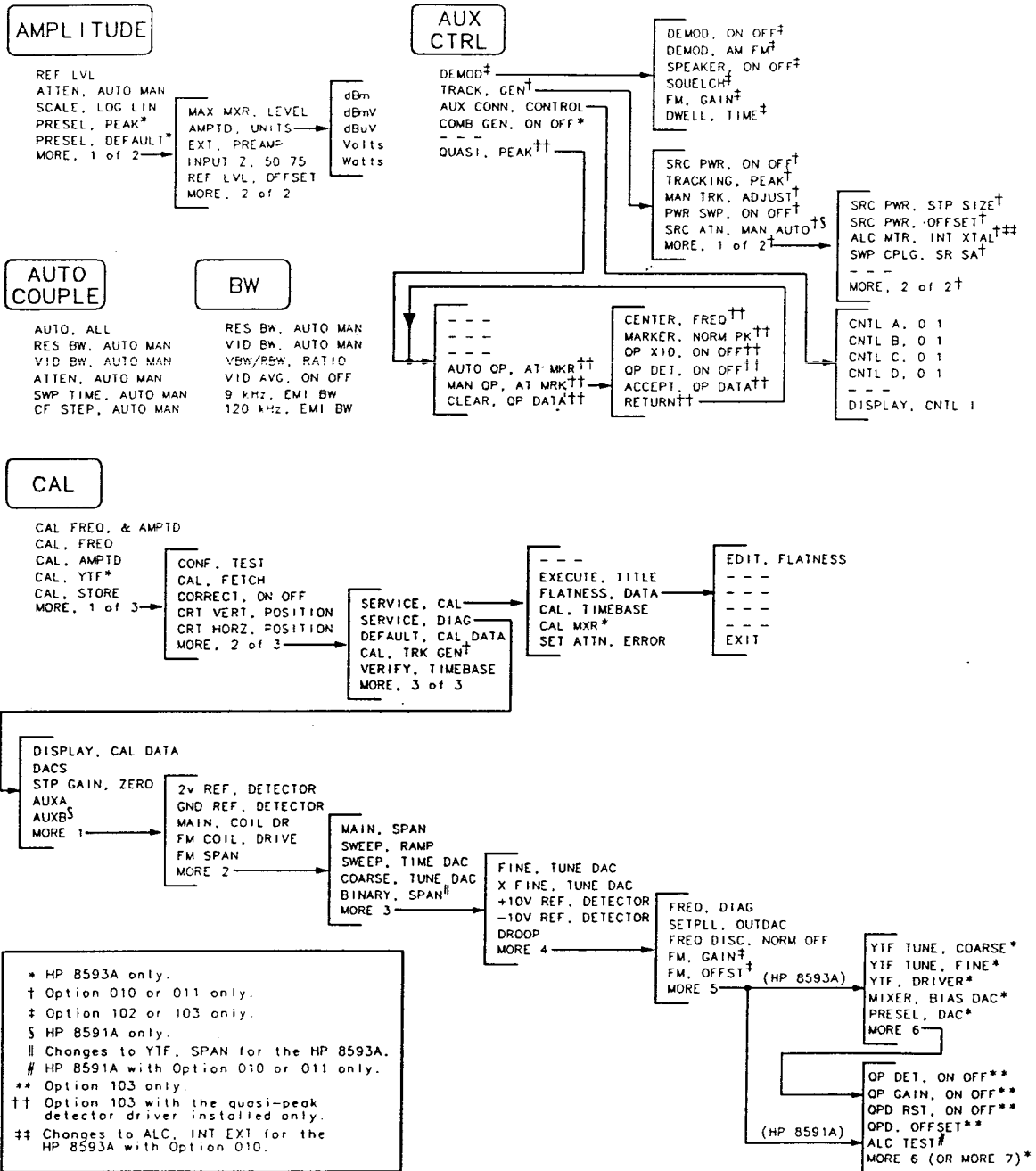

## 4-6 Key Menus

# HP 8591A/8593A KEY MENUS

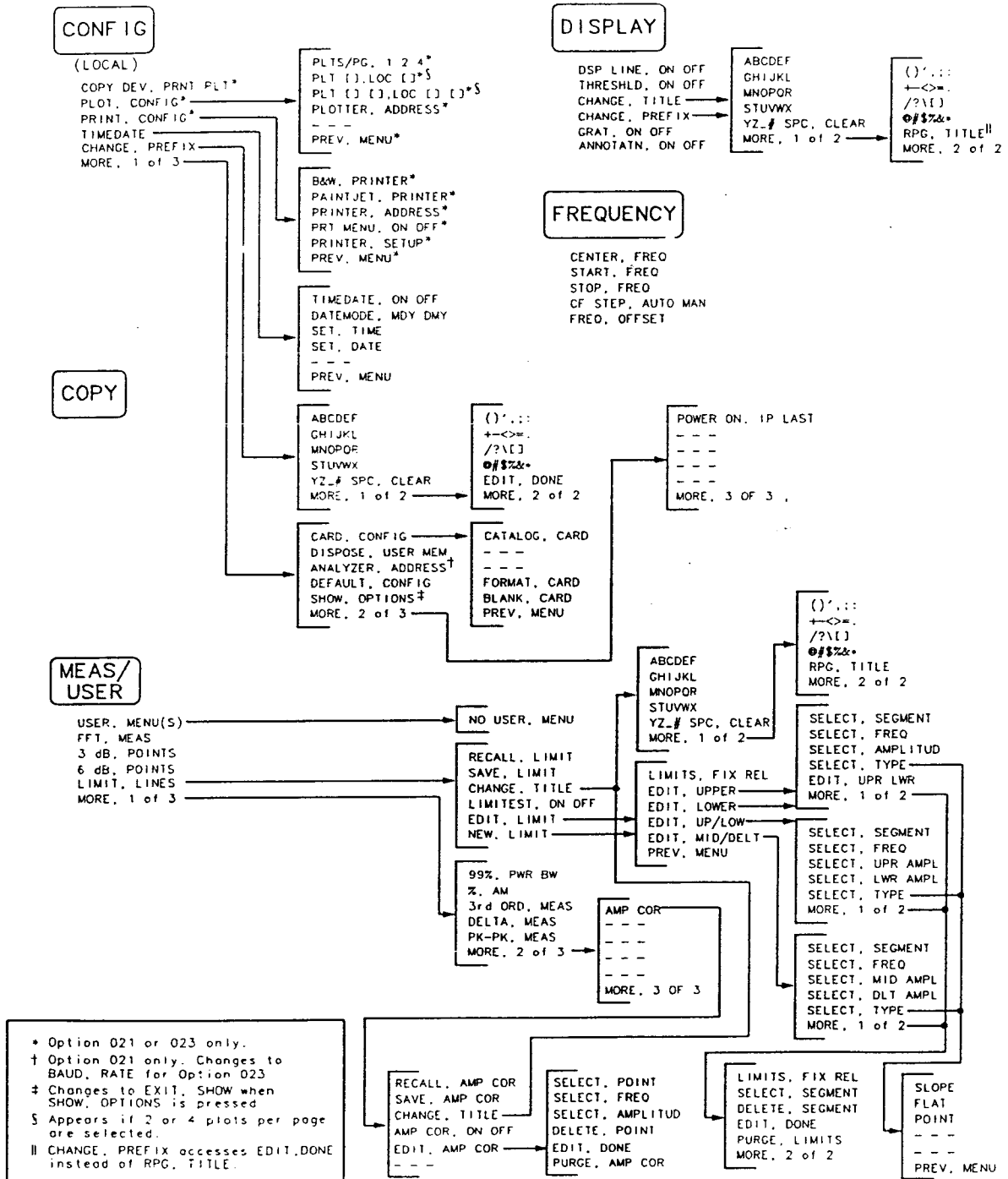

\* Option 021 or 023 only.  
 † Option 021 only. Changes to BAUD, RATE for Option 023  
 ‡ Changes to EXIT, SHOW when SHOW, OPTIONS is pressed  
 § Appears if 2 or 4 plots per page are selected.  
 || CHANGE, PREFIX accesses EDIT, DONE instead of RPG, TITLE.

# HP 8591A/8593A KEY MENUS

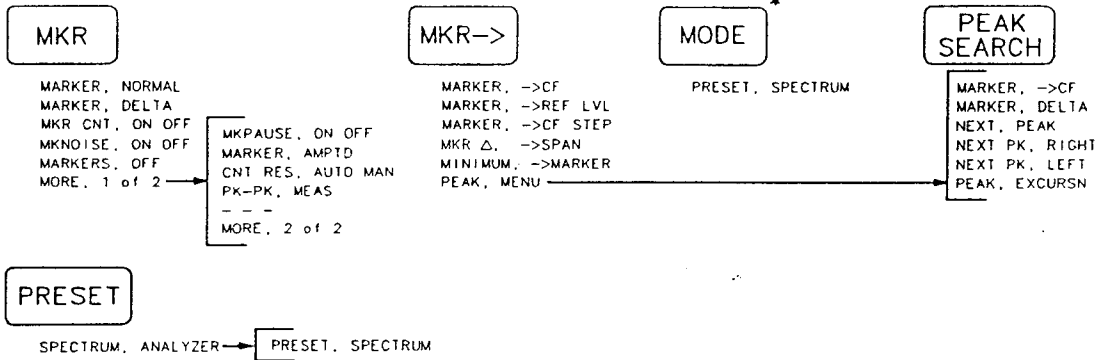

FOR RECALLING AND SAVING TO ANALYZER MEMORY:

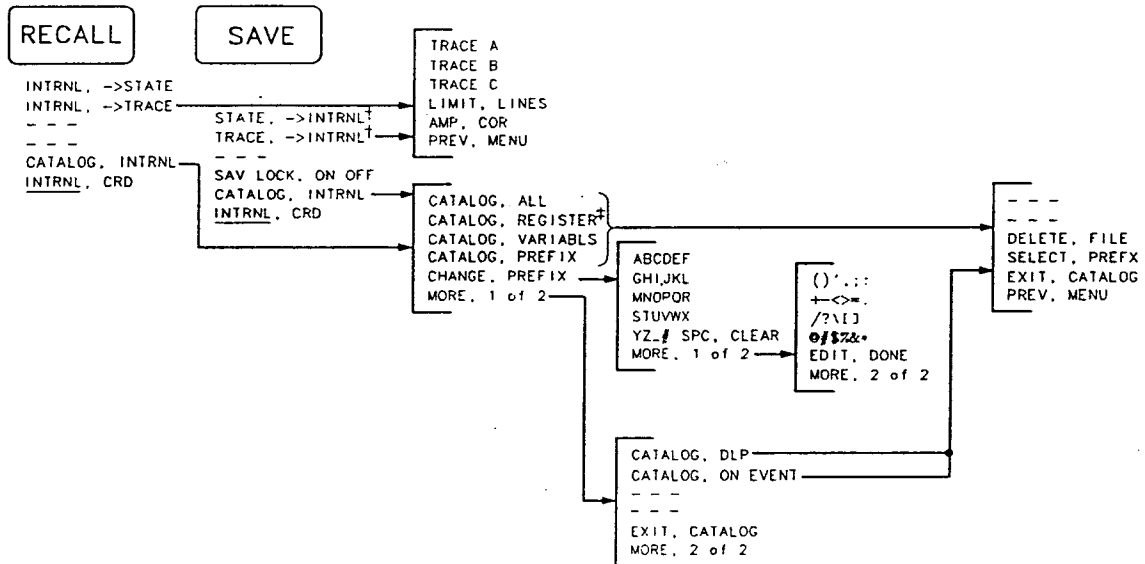

\* Changes to the Preset menu.  
 † Changes to MEM, LOCKED when SAV LOCK is ON.  
 ‡ CATALOG, REGISTER accesses LOAD, FILE instead of DELETE, FILE.

# HP 8591A/8593A KEY MENUS

FOR RECALLING AND SAVING TO THE MEMORY CARD:

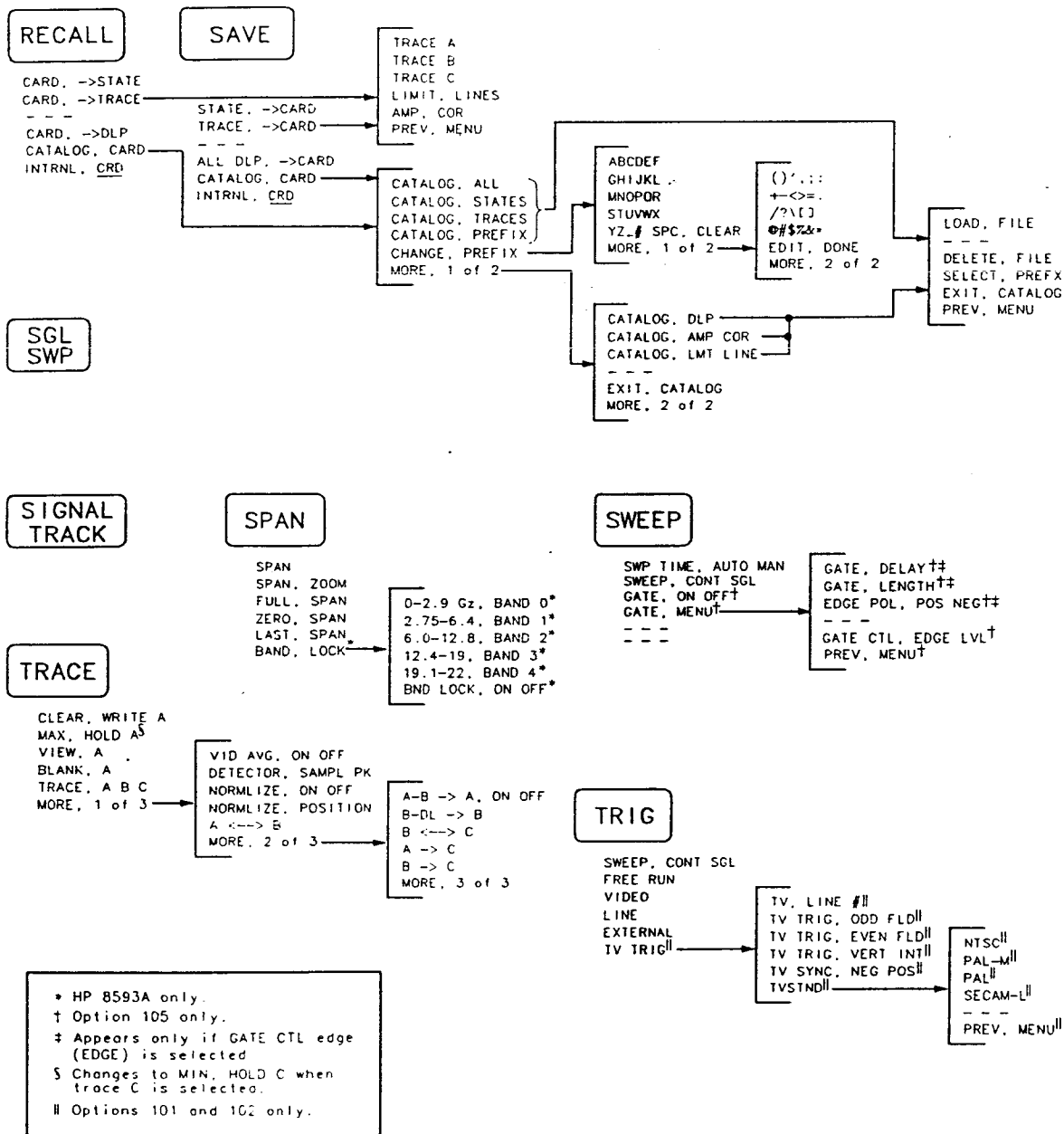

# HP 8594A/8595A KEY MENUS

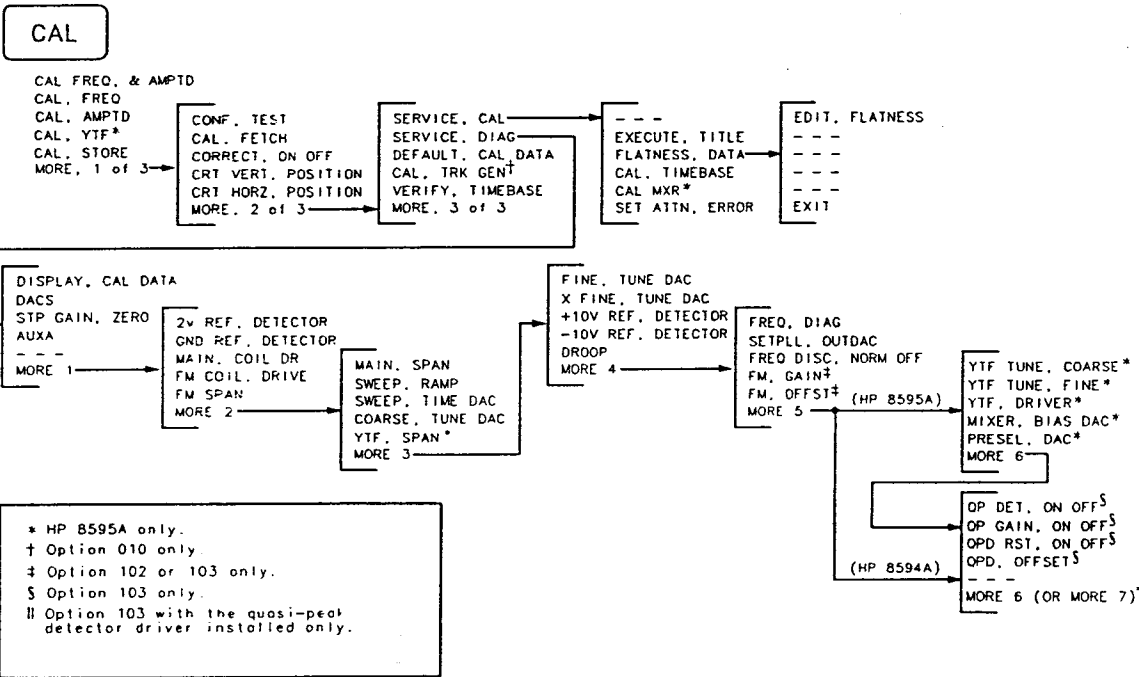
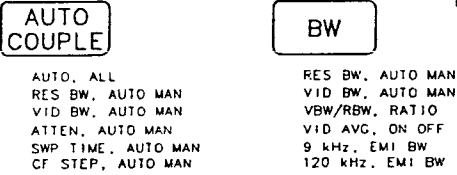
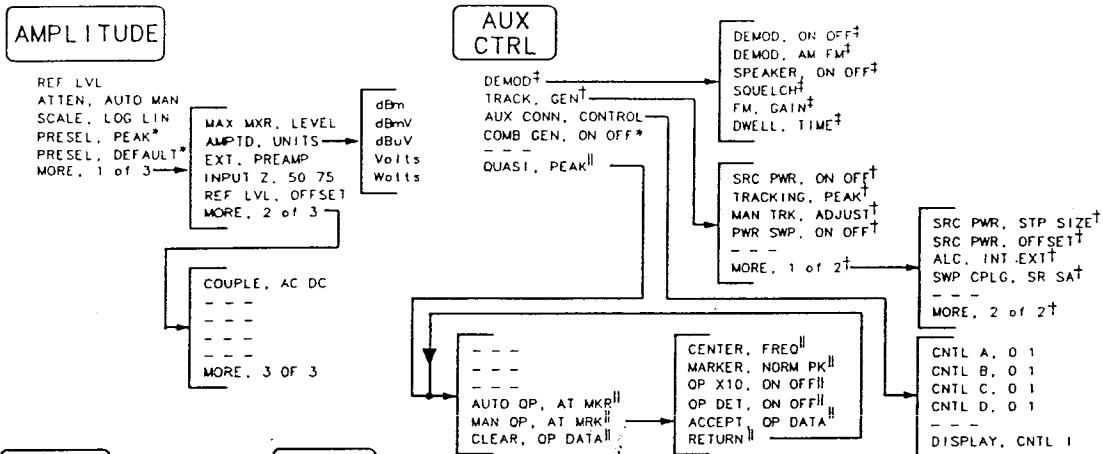

# HP 8594A/8595A KEY MENUS

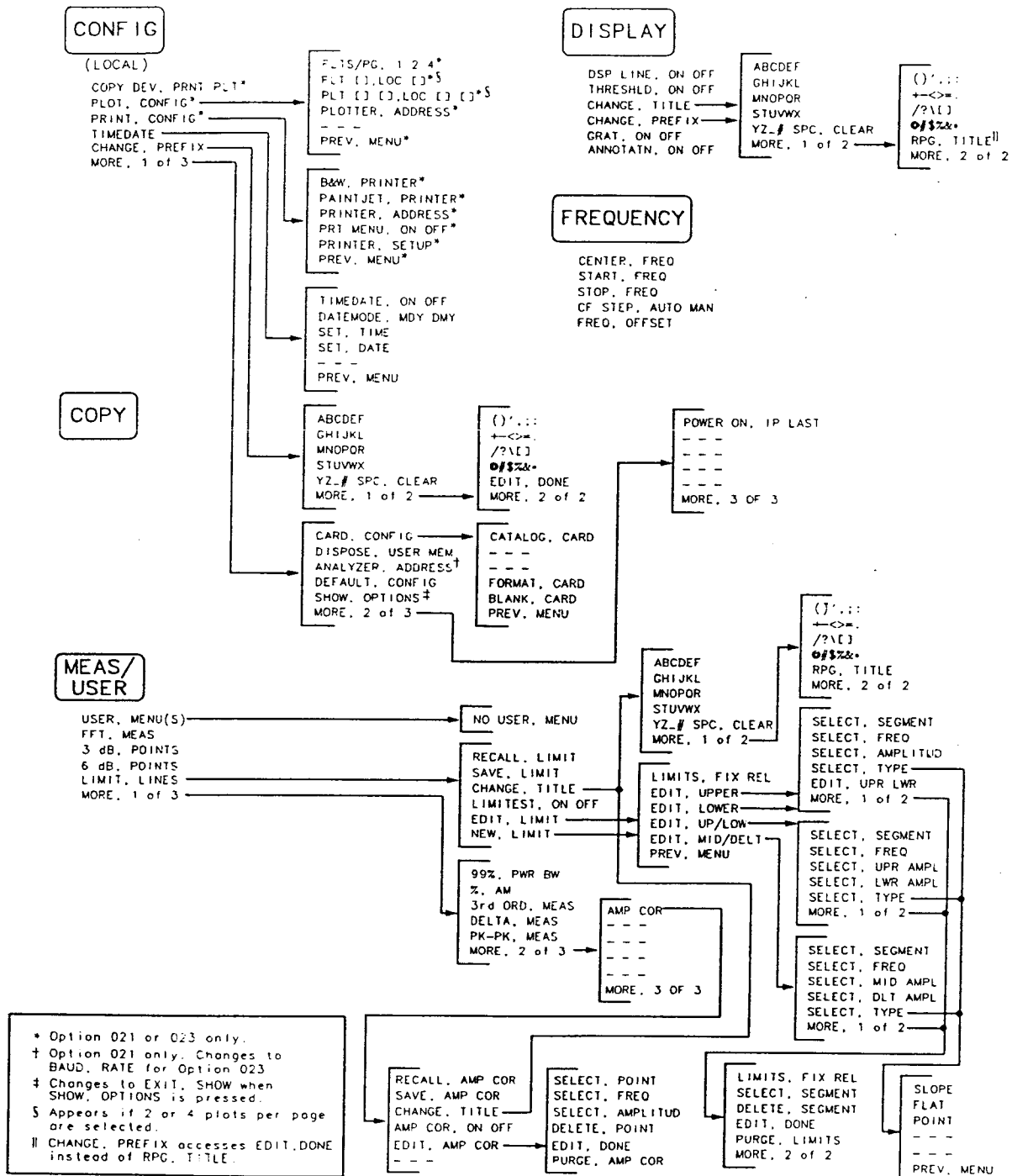

# HP 8594A/8595A KEY MENUS

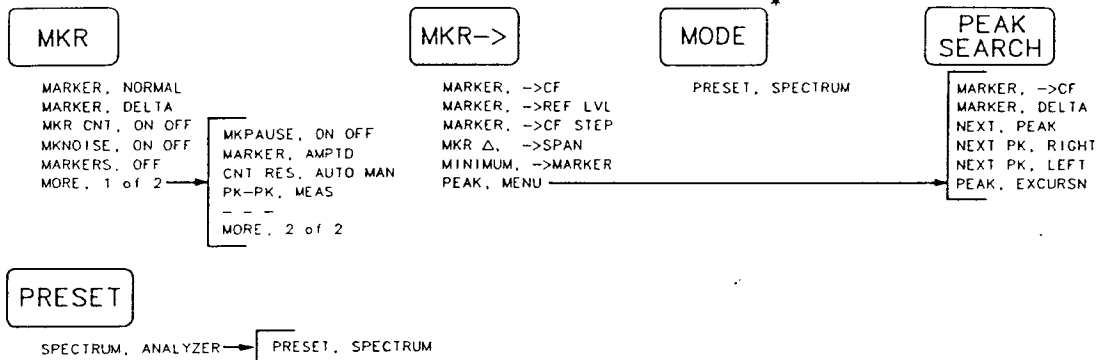

FOR RECALLING AND SAVING TO ANALYZER MEMORY:

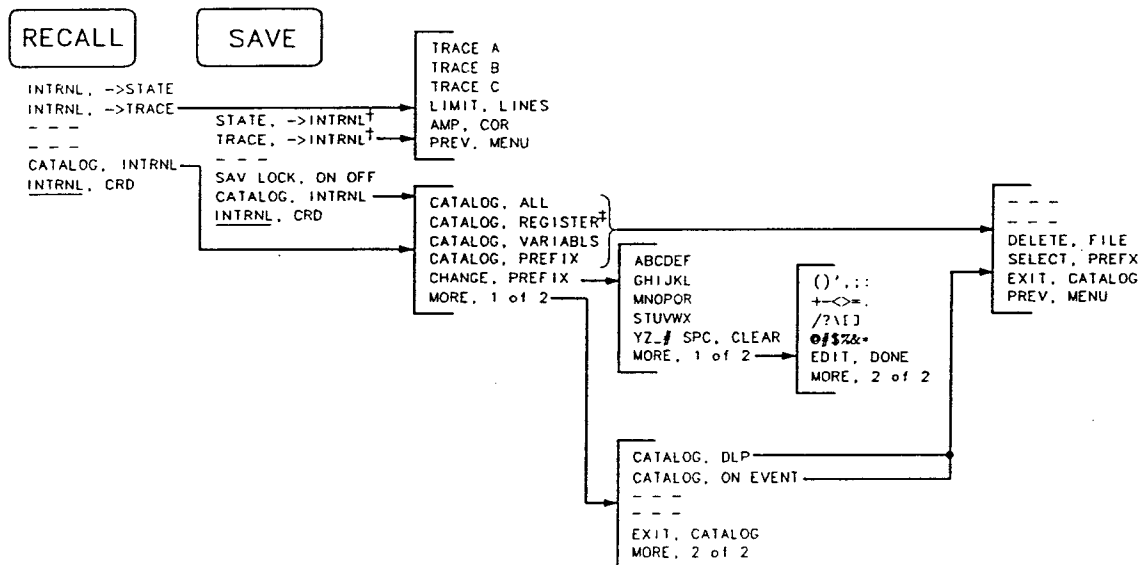

\* Changes to the Preset menu.  
 † Changes to MEM. LOCKED when SAV LOCK is ON.  
 ‡ CATALOG, REGISTER accesses LOAD, FILE instead of DELETE, FILE.

# HP 8594A/8595A KEY MENUS

FOR RECALLING AND SAVING TO THE MEMORY CARD:

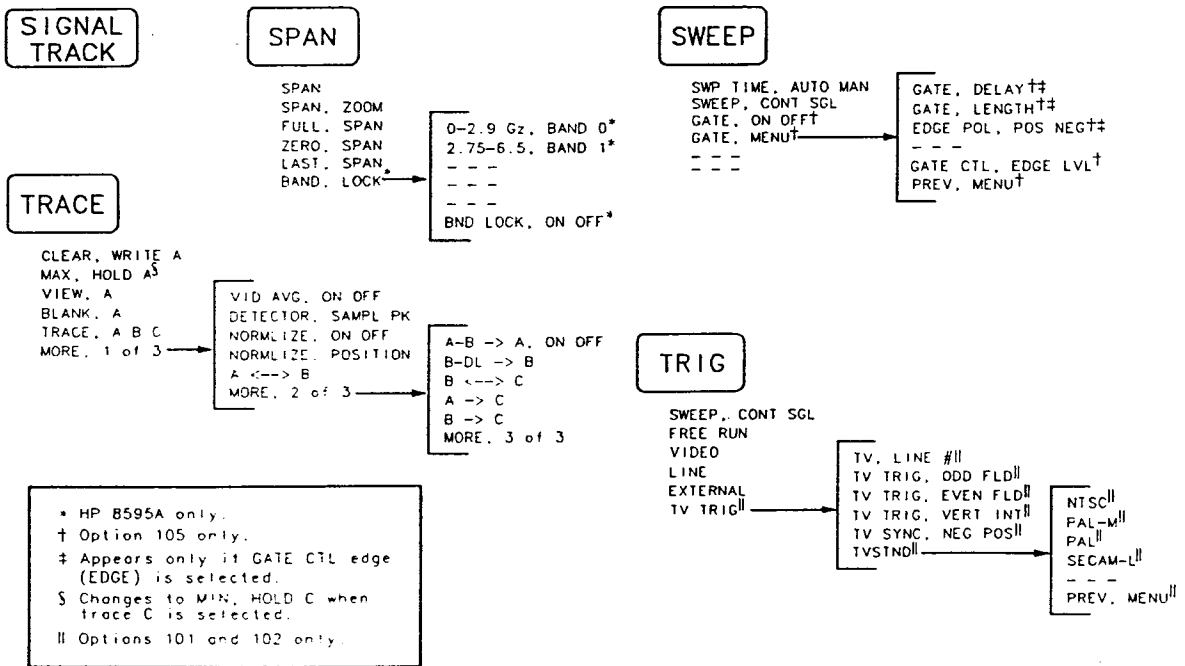
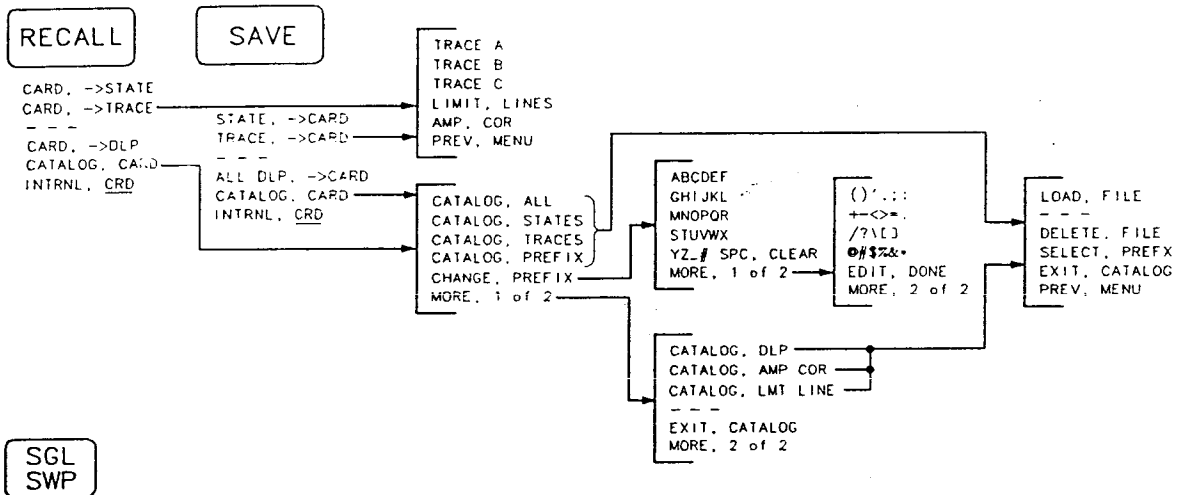





# Index

---

## 0

0-2.9 Gz BAND 0, 3-15, 3-19

## 1

100 MHz COMB OUT, 1-3  
10 MHz reference DAC setting, 3-21  
10 MHz REF OUTPUT, 1-5  
+10V REF DETECTOR, 3-13, 3-15  
-10V REF DETECTOR, 3-13, 3-15  
120 kHz EMI BW, 3-16  
12.4-19. BAND 3, 3-16, 3-19  
19.1-22 BAND 4, 3-16, 3-19

## 2

2.75-6.4 BAND 1, 3-15, 3-19  
2.75-6.5 BAND 1, 3-15  
2v REF DETECTOR, 3-13, 3-15

## 3

3 dB POINTS, 3-15  
3rd ORD MEAS, 3-15

## 6

6.0-12.8 BAND 2, 3-15, 3-19  
6 dB POINTS, 3-15

## 9

99% PWR BW, 3-16  
9 kHz EMI BW, 3-15

## A

ABCDEF, 3-16  
ABORT, 3-16  
A -> C, 3-16  
ACCEPT QP DATA, 3-16  
accessing the gate menu  
    GATE MENU, 3-42  
ac coupling, 3-34  
active function, 1-11  
active function block, 1-1  
addressing printer, 3-54  
address of analyzer, 3-17  
address of plotter, 3-49  
A <-> B, 3-16  
ALC MTR INT XTAL, 3-17

ALC TEST, 3-13, 3-17

ALL DLP -> CARD, 1-28, 3-17

%AM, 3-15

AM/FM demodulation

    use with Option 105, 2-52

A-B -> A ON OFF, 3-16

AMP COR, 1-44, 3-17

AMP COR ON OFF, 1-44, 1-46, 3-17

AMPLITUDE, 1-2, 1-12, 3-17

    amplitude accuracy, 3-34

    amplitude and frequency self-calibration routines,  
        3-21

    amplitude correction

        amplitude coordinate, 1-46

        frequency coordinate, 1-45

        point, 1-45

        testing, 1-46

        using RECALL AMP COR, 1-46

        using SAVE AMP COR, 1-46

    amplitude correction factors

        cataloging, 3-22

        delete point, 3-36

        edit, 3-38

        edit done, 3-38

        menus, 3-17

        on and off, 3-17

        purge, 3-54

        recall table, 3-56

        save table, 3-58

        select amplitude, 3-59

        select frequency, 3-59

        select point, 3-60

    amplitude-correction functions , 1-41, 1-44-46

    amplitude corrections

        creating, 1-42

        editing, 1-43

    amplitude menus, 3-17

    amplitude modulation, 3-15

    amplitude scale, 3-58

    amplitude self-calibration, 3-21

    amplitude units, 3-17

        dBm, 3-35

        dBmV, 3-35

        dBuV, 3-35

        Volts, 3-68

        Watts, 3-68

AMPTD UNITS, 3-17  
 ANALYZER ADDRESS, 3-17  
 analyzer attenuator, 3-18  
 analyzer configuration, default, 3-35  
 analyzer memory  
   cataloging functions, 3-24  
   catalog variables, 3-27  
   delete file, 3-35  
   DLP cataloging, 3-24  
   erase user programs and variables, 3-37  
   program and variable cataloging, 3-22  
   recalling amplitude-correction factors, 1-20  
   recalling a state, 1-18  
   recalling a trace, 1-1<sup>0</sup>  
   recalling limit lines, 1-20  
   saving amplitude-correction factors, 1-20  
   saving and recalling data, 1-18  
   saving a state, 1-18  
   saving a trace, 1-19  
   saving limit lines, 1-20  
   saving to, 3-65  
   state and trace register status, 3-27  
 analyzer distortion products, 2-23  
 annotation, 1-9  
 ANNOTATN ON OFF, 3-17  
 ATTEN AUTO MAN, 3-18  
 attenuator-error factors, 3-60  
 AUTO ALL, 3-18  
 AUTO COUPLE, 3-18  
 automatic leveling control, 3-17  
 automatic quasi-peak routine, 3-18  
 AUTO QP AT MKR, 3-18  
 AUX A, 3-13, 3-19  
 AUX B, 3-13, 3-19  
 AUX CONN CONTROL, 3-19  
 AUX CTRL, 3-19  
 AUX IF OUTPUT, 1-6  
 auxiliary connector input, 3-37  
 auxiliary interface connector, 3-19  
 auxiliary interface control line A, 3-31  
 auxiliary interface control line B, 3-31  
 auxiliary interface control line C, 3-31  
 auxiliary interface control line D, 3-31  
 AUX INTERFACE, 1-6  
 AUX VIDEO OUTPUT, 1-6

## B

band boundaries, measuring signals near, 2-33  
 BAND LOCK, 2-33, 3-19  
 band locking, 3-20  
 bandwidth functions, 3-21  
 BAUD RATE, 3-20  
 B -> C, 3-19  
 B <—> C, 3-19  
 bias-current DAC adjustment, 3-21

BINARY SPAN, 3-13, 3-20  
 black and white print, 3-19  
 BLANK A, 3-20  
 BLANK B, 3-20  
 BLANK C, 3-20  
 BLANK CARD, 1-24, 3-20  
 B-DL -> B, 3-19  
 BND LOCK ON OFF, 2-33, 3-20  
 BW, 3-21  
 B & W PRINTER, 3-19

## C

CAL, 1-15, 3-21  
 CAL AMPTD, 1-15, 3-21  
 CAL FET'CH, 1-15, 3-21  
 CAL FREQ, 1-15, 3-21  
 CAL FREQ & AMPTD, 1-15, 3-21  
 calibration, 3-21  
   attenuator-error factors, 3-60  
   self-calibration routines, 1-15  
 CAL MXR, 3-13, 3-21  
 CAL OUT, 1-3  
 CAL STORE, 1-15, 3-21  
 CAL TIMEBASE, 3-13, 3-21  
 CAL TRK GEN, 1-16, 3-21  
 CAL YTF, 1-17, 3-22  
 CARD CONFIG, 3-22  
 CARD ->DLP, 3-22  
 CARD ->STATE, 3-22  
 CARD ->TRACE, 3-22  
 CATALOG ALL, 3-22  
 CATALOG AMP COR, 3-22  
 CATALOG CARD, 1-24, 3-23  
 CATALOG DLP, 3-24  
 CATALOG INTRNL, 3-24  
 CATALOG LMT LINE, 3-26  
 CATALOG ON EVENT, 3-26  
 CATALOG PREFIX, 3-27  
 CATALOG REGISTER, 3-27  
 CATALOG STATES, 3-27  
 CATALOG TRACES, 3-27  
 CATALOG VARIABLES, 3-27  
 CENTER FREQ, 3-28  
 center frequency, 3-28  
 center-frequency step size, 3-28  
 CF STEP AUTO MAN, 3-28  
 change function values, 1-7  
 CHANGE PREFIX, 3-28  
 CHANGE TITLE, 3-28  
 check analyzer operation, 3-32  
 CLEAR, 3-29  
 clear frequency offset, 3-29  
 CLEAR OFFSET, 3-29  
 CLEAR QP DATA, 3-29  
 CLEAR WRITE A, 3-29

## Index-2

CLEAR WRITE B, 3-30  
 CLEAR WRITE C, 3-30  
 CNTL A 0 1, 3-31  
 CNTL B 0 1, 3-31  
 CNTL C 0 1, 3-31  
 CNTL D 0 1, 3-31  
 CNT RES AUTO MAN, 2-6, 3-31  
 COARSE TUNE DAC, 3-13, 3-31  
 comb generator, more accurate frequency  
     measurements, 2-35  
 COMB GEN ON OFF, 2-33, 3-31  
 common measurements  
     stimulus-response, 2-39-45  
 common preset conditions, 3-51  
 comparing signals, 2-13  
 confidence test, 3-32  
 CONFIG, 3-31  
 configuration, printer, 3-54  
 CONF TEST, 3-32  
 connector  
     100 MHz comb out, 1-3  
     10 MHz ref output, 1-5  
     AUXA, 3-19  
     AUXB, 3-19  
     aux IF output, 1-6  
     aux video output, 1-6  
     cal output, 1-3  
     earphone, 1-5  
     ext alc input, 1-6  
     external keyboard, 1-6  
     ext ref in, 1-6  
     ext trig input, 1-6  
     gate output, 1-5  
     gate trigger input, 1-5  
     hi sweep in/out, 1-6  
     HP-IB interface, 1-6  
     LO output, 1-5  
     monitor output, 1-6  
     sweep output, 1-7  
     sweep + tune output, 1-5  
     TV trig output, 1-5  
 CONTINUE, 3-32  
 continuous sweep, 3-63  
 control functions, 1-3  
 control line A, auxiliary interface, 3-31  
 control line B, auxiliary interface, 3-31  
 control line C, auxiliary interface, 3-31  
 control line D, auxiliary interface, 3-31  
 controlling the gate  
     GATE CTL EDGE LVL, 3-41  
     GATE ON OFF, 3-42  
 COPY, 1-3, 3-32  
 COPY DEV PRNT PLT, 3-34  
 correction factor data displayed, 3-37  
 correction factors, 1-15, 1-16, 3-34

correction factors, predetermined, 3-35  
 correction factors, self-calibration, 3-21  
 correction factors, storing of, 3-21  
 CORRECT ON OFF, 1-16, 3-34  
 CORRECT TO COMB, 3-34  
 COUPLE AC DC, 3-34  
 coupled functions menu, 3-18  
 coupled sweep time, 3-63  
 coupling  
     COUPLE AC DC, 3-34  
     coupling functions, 3-18  
     coupling video bandwidth, 3-67  
 creating amplitude-correction factors, 1-42  
 creating limit lines, 1-31  
 CRT HORZ POSITION, 3-34  
 CRT VERT POSITION, 3-34

## D

### DAC

    extra fine-tune, 3-68  
     fine tune, 3-40  
     mixer bias, 3-46  
     sweep time, 3-63  
     YTF coarse tune, 3-68  
     YTF fine-tune, 3-68  
 DAC adjustment for bias current, 3-21  
 DACS, 3-13, 3-34  
 data controls, 1-7  
 data keys, 1-3, 1-7  
 data protection, 1-20  
 data recall, 3-56  
 data transmission speed, 3-20  
 DATEMODE MDY DMY, 3-35  
 dBm, 3-35  
 dBmV, 3-35  
 dBuV, 3-35  
 dc coupling, 3-34  
 deactivate function, 1-7  
 DEFAULT CAL DATA, 3-35  
 DEFAULT CONFIG, 3-35  
 delay  
     GATE DELAY, 3-42  
 DELETE FILE, 3-35  
 delete files from memory card, 3-20  
 DELETE POINT, 3-36  
 DELETE SEGMENT, 3-36  
 delta marker, 2-13  
 delta markers, 3-45  
 DELTA MEAS, 2-15, 3-36  
 DEMOD, 2-46, 3-36  
 DEMOD AM FM, 2-46, 3-36  
 DEMOD ON OFF, 2-46, 3-36  
 demodulating an AM or FM signal, 2-46  
 demodulation, 3-36  
     AM, 3-36

continuous, 2-47  
 dwell time, 3-37  
 FM, 3-36  
 FM gain, 3-40  
 FM offset, 3-40  
 on and off, 3-36  
 speaker on off, 3-61  
 squelch, 3-62  
 detection mode  
   peak, 3-36  
   sample, 3-36  
 detector, quasi peak, 3-55  
 DETECTOR SAMPLE PK, 3-36  
 determining gate delay, 2-58  
 determining gate length, 2-58  
 disable peak detector reset, 3-37  
 DISPLAY, 3-37  
 DISPLAY CAL DATA, 3-13, 3-37  
 DISPLAY CNTL 1, 3-37  
 display line, 3-37  
 DISPOSE USER MEM, 3-37  
 distortion products, 2-23  
 DLP, 1-28  
 DLP cataloging, 3-24  
 downloadable programs, 1-28  
 DROOP, 3-13, 3-37  
 DSP LINE ON OFF, 3-37  
 DWELL TIME, 3-37  
  
**E**  
 earphone connector, 1-5  
 EDGE POL POS NEG, 3-38  
 edge triggering  
   positive or negative, 3-38  
 EDIT AMP COR, 1-45, 3-38  
 EDIT DONE, 1-33, 1-39, 1-44, 1-46, 3-38  
 EDIT FLATNESS, 3-13, 3-38  
 editing amplitude corrections, 1-43  
 editing limit lines, 1-32  
 EDIT LIMIT, 1-32, 1-34, 3-38  
 EDIT LOWER, 1-34, 3-38  
 EDIT MID/DELT, 1-34, 3-38  
 EDIT UP/LOW, 1-34, 3-39  
 EDIT UPPER, 1-32, 1-34, 3-39  
 EDIT UPR LWR, 3-39  
 EMI bandwidth, 120 kHz, 3-16  
 EMI bandwidth, 9 kHz, 3-15  
 entering a prefix, 1-25  
 erase user programs and variables, 3-37  
 exchange trace A and B, 3-16  
 exchange trace B and C, 3-19  
 EXECUTE TITLE, 3-13, 3-39  
 EXIT, 3-39  
 EXIT CATALOG, 3-39  
 exit correct-to-comb routine, 3-16

EXIT SHOW, 3-39  
 EXT ALC INPUT, 1-6  
 EXTERNAL, 3-39  
 external keyboard, 1-47  
   prefix entry, 1-49  
   programming command entry, 1-49  
   screen title entry, 1-49  
 external keyboard connector, 1-6  
 external keyboard installation, 1-48  
 external keyboard operation, 1-48-49  
 EXT KEYBOARD, 1-6  
 EXT PREAMP, 3-39  
 EXT REF IN, 1-6  
 EXT TRIG INPUT, 1-6

## F

fast Fourier transform, 3-40  
 fast Fourier transform function, 2-29  
 features  
   front panel, 1-1  
 FFT MEAS, 2-29, 3-40  
 fine-focus control, 1-8  
 FINE TUNE DAC, 3-14, 3-40  
 fix-tuned receiver, 2-27  
 FLAT, 1-38, 3-40  
 flatness correction constants, 3-38, 3-40  
 FLATNESS DATA, 3-13, 3-40  
 FM COIL DRIVE, 3-14, 3-40  
 FM GAIN, 2-47, 3-14, 3-40  
 FM OFFSET, 3-14  
 FM OFFST, 3-40  
 FM SPAN, 3-14, 3-40  
 FORMAT CARD, 1-24, 3-40  
 format date, 3-35  
 FREE RUN, 3-40  
 FREQ DIAG, 3-14, 3-40  
 FREQ DISC NORM OFF, 3-14, 3-40  
 FREQ OFFSET, 3-41  
 FREQUENCY, 1-2, 1-12, 3-41  
 frequency and amplitude differences, 3-36  
 frequency and amplitude self-calibration routines,  
   3-21  
 frequency offset, 3-41  
 frequency offset, clear, 3-29  
 frequency of sampling oscillator, 3-61  
 frequency range, full span, 3-41  
 frequency self-calibration, 3-21  
 frequency span, 3-61  
 front-panel features, 1-1-4  
 FULL SPAN, 3-41  
 functional check of Option 105, 2-55  
 function coupling, 3-18  
 fuse holder, 1-6

## G

- gate control
  - GATE CTL EDGE LVL, 3-41
  - Option 105, 2-57
- GATE CTL EDGE LVL, 3-41
  - operation, 2-56
- gate delay
  - determining the gate delay, 2-58
  - setting gate delay properly, 2-64
- GATE DELAY, 3-42
- gate length
  - determining the gate length, 2-58
  - setting gate length properly, 2-64
- GATE LENGTH, 3-42
- GATE MENU, 3-42
- GATE ON OFF, 3-42
- GATE OUTPUT, 1-5
- GATE TRIGGER INPUT, 1-5
- GHIJKL, 3-42
- GND REF DETECTOR, 3-14, 3-42
- GRAT ON OFF, 3-42
- guidelines for using Option 105, 2-58

## H

- hardware error messages, A-1
- harmonic band 0, 3-15
- harmonic band 1, 3-15
- harmonic band 2, 3-15
- harmonic band 3, 3-16
- harmonic band 4, 3-16
- harmonic band menu, 3-19
- harmonic band slope and offset adjust, 3-22
- harmonic lock, 2-33, 3-20
- highest peak, next, 3-47
- HI SWEEP IN/OUT, 1-6
- HOLD, 1-7
- horizontal signal positioning, 3-34
- HP 8590B/8592B key menus, 4-2-5
- HP 8591A/8593A key menus, 4-6-9
- HP 8594A/8595A key menus, 4-10-13
- HP-IB address, 3-17
- HP-IB interface connector, 1-6
- HP Paintjet, 3-48

## I

- identifying distortion products, 2-23
- increased frequency accuracy, 3-34
- increase frequency readout resolution, 2-6
- informational messages, A-1
- INPUT 50 $\Omega$ , 1-3
- INPUT 75 $\Omega$ , 1-3
- input and output
  - auxiliary control, 3-19
- input attenuation control, 3-18

- input impedance, 3-42
- INPUT Z 50 75, 3-42
- installation, external keyboard, 1-48
- instrument preset, 3-50
- instrument state, 1-2
- intensity control, 1-3
- interface connectors, 1-6
- intermodulation distortion, third order, 2-25
- internal comb generator, 3-31
- internal/external leveling, 3-16
- INTRNL CRD, 3-42
- INTRNL ->STATE, 3-42
- INTRNL ->TRACE, 3-42

## K

- keyboard
  - external keyboard functions, 1-47
- keyboard, external, 1-47
- keyboard operation, external, 1-48
- key functions, external keyboard, 1-47
- key menus, 4-1
- knob, 1-3, 1-7

## L

- label, softkey, 1-2
- LAST SPAN, 3-43
- length
  - GATE LENGTH, 3-42
- LIMITEST ON OFF, 1-33, 1-39, 3-43
- LIMIT FAIL, 1-31
- limit-line functions, 1-34-39
- limit lines, 1-31
  - amplitude coordinate, 1-37
  - cataloging, 3-26
  - clear table, 3-47
  - creating, 1-31-33
  - delete segment, 3-36
  - edit done, 3-38
  - editing, 1-32
  - edit limit, 3-38
  - edit lower, 3-38
  - edit mid/delta amplitude, 3-38
  - edit upper and lower tables, 3-39
  - edit upper table, 3-39
  - fixed, 1-34
  - fixed and relative, 3-43
  - frequency coordinate, 1-37
  - point, 3-49
  - purge, 3-54
  - recall table, 3-56
  - relative, 1-34
  - save table, 3-58
  - segment number, 1-35
- SEGMENT TYPE, 1-38
- select amplitude, 3-59

- select delta amplitude, 3-59
- select frequency, 3-59
- select lower amplitude, 3-59
- select middle amplitude, 3-59
- select segment, 3-60
- select type, 3-60
- select upper amplitude, 3-60
- table format, 1-34
- table type, 1-34
- testing, 1-39, 3-43
- upper and lower, 1-39, 3-39
- using RECALL LIMIT, 1-39
- using SAVE LIMIT, 1-39
- LIMIT LINES, 1-34, 3-43
- limit-line type
  - flat, 3-40
  - slope, 3-61
- LIMIT PASS, 1-31
- LIMITS FIX REL, 1-32, 1-34, 3-43
- LINE, 3-43
- linear scale, 3-58
- LINE front-panel key, 1-4
- LINE switch, 1-4
- LOAD FILE, 3-43
- (LOCAL), 3-31, 3-44
- local operation, 3-31, 3-44
- lock, harmonic band, 3-20
- lock internal state and trace registers, 3-58
- log scale, 3-58
- LO OUTPUT, 1-5
- lower limit line, 1-35
- lower limit lines, editing, 3-38
- low-level signals, 2-17
  - reducing attenuation, 2-17
  - reducing resolution bandwidth, 2-19
  - reducing video bandwidth, 2-20
  - video averaging, 2-21

## M

- MAIN COIL DR, 3-14, 3-44
- MAIN SPAN, 3-14, 3-44
- making a measurement, 1-12-13
- MAN QP AT MKR, 3-44
- MAN TRK ADJUST, 2-43, 3-44
- manual tracking adjustment, 3-44
- marker, 3-46
- MARKER, 1-13
- MARKER AMPTD, 3-44
- MARKER ->CF, 3-45
- MARKER ->CF STEP, 3-45
- marker counter, 2-6, 3-46
  - use with Option 105, 2-52
- marker counter resolution, 3-31
- marker delta, 2-13
- MARKER DELTA, 2-14, 3-45

- marker functions, 1-3
- marker noise, 3-46
  - use with Option 105, 2-52
- MARKER NORMAL, 1-13, 3-45
- MARKER NORM PK, 3-45
- marker pause, 3-46
- marker pause, dwell time, 3-37
- MARKER ->REF LVL, 3-45
- MARKERS OFF, 3-45
- marker to, 3-46
- mass storage device
  - analyzer memory, 3-42
  - memory card, 3-42
- MAX HOLD A, 2-11, 3-45
- MAX HOLD B, 3-45
- maximum hold, 2-10
- maximum mixer level, 3-46
- MAX MXR LEVEL, 3-46
- measuring amplitude modulation, 2-29
- measuring low-level signals, 2-17
- measuring return loss, 2-51
- measuring signals near band boundaries, 2-33
- MEAS/USER, 3-46
- MEM LOCKED, 3-58
- memory card
  - blank card, 1-24
  - card configuration, 3-22
  - cataloging, 1-24
  - cataloging amplitude correction factor files, 3-22
  - cataloging functions, 3-23
  - catalog states, 3-27
  - catalog traces, 3-27
  - delete file, 3-35
  - DLP cataloging, 3-24
  - formatting, 1-24, 3-40
  - limit-line cataloging, 3-26
  - preparation for use, 1-23
  - program and variable cataloging, 3-22
  - recall DLP, 3-22
  - recalling amplitude-correction factors, 1-27
  - recalling a program, 1-29
  - recalling a state, 1-25
  - recalling a trace, 1-26
  - recalling limit lines, 1-27
  - recall state, 3-22
  - recall trace, 3-22
  - save current state, 3-62
  - saving amplitude-correction factors, 1-27
  - saving and recalling data, 1-22
  - saving and recalling programs, 1-28
  - saving a program, 1-28
  - saving a state, 1-25
  - saving a trace, 1-26
  - saving limit lines, 1-27

- saving to, 3-64
- memory card reader, 1-3
- menu and softkey overview, 1-11
- menus, 4-1
- menu trees, 4-1
- message block, 1-1
- mid/delta amplitude, editing, 3-38
- mid/delta limit-line format, 1-35
- MIN HOLD C, 2-12, 3-46
- minimum hold, 2-10
- MINIMUM ->MARKER, 3-46
- MIXER BIAS DAC, 3-14, 3-46
- MKNOISE ON OFF, 3-46
- MKPAUSE ON OFF, 3-46
- MKR, 3-46
- MKR ->, 3-46
- MKR CNT ON OFF, 2-6, 3-46
- MKR  $\Delta$  ->SPAN, 3-47
- MNOPQR, 3-47
- MODE, 1-2, 3-47
- model specific preset conditions, 3-52
- MONITOR OUTPUT, 1-6
- more accurate frequency measurements, using
  - comb generator, 2-35
- move trace A into C, 3-16
- multipen plotter, 3-33

## N

- NEW LIMIT, 1-32, 1-34, 3-47
- NEXT PEAK, 3-47
- NEXT PK LEFT, 3-47
- NEXT PK RIGHT, 3-47
- normalization, 2-43
- normal marker, 3-45
- normal marker, quasi peak, 3-45
- NORMLIZE ON OFF, 2-43, 3-47
- NORMLIZE POSITION, 3-47
- NO USER MENU, 3-48
- NTSC, 3-48
- number/units keypad, 1-7

## O

- ONCYCLE command, 3-26
- ONDELAY command, 3-26
- ONEOS command, 3-26
- on event commands
  - ONCYCLE, 3-26
  - ONDELAY, 3-26
  - ONEOS, 3-26
  - ONMKR, 3-26
  - ONSRQ, 3-26
  - ONSWP, 3-26
  - ONTIME, 3-26
  - TRMATH, 3-26
- ONMKR command, 3-26

- on/off switch, 1-4
- on-screen signal positioning
  - horizontal, 3-34
  - vertical, 3-34
- ONSRQ command, 3-26
- ONSWP command, 3-26
- ONTIME command, 3-26
- operating Option 105, 2-52
- operation, local, 3-44
- Option 101
  - use with Option 105, 2-54
- Option 105
  - analyzer settings, 2-57, 2-58
  - example of using time-gating, 2-57
  - functional check, 2-55
  - operation, 2-52
  - self-calibration routines, 2-54
  - table of analyzer settings, 2-65
- options displayed, 3-61
- output power, 3-62
- output screen data, 3-32
- overview, menus and softkeys, 1-11

## P

- PAINTJET PRINTER, 3-48
- PAL, 3-48
- PAL-M, 3-48
- peak detection mode, 3-36
- PEAK EXCURSN, 3-48
- peaking signal amplitude, 2-9
- PEAK MENU, 3-49
- peak response routine, 3-65
- PEAK SEARCH, 1-13, 3-49
- percent amplitude modulation, 3-15
- PK-PK MEAS, 3-49
- PLOT CONFIG, 3-49
- PLOTTER ADDRESS, 3-49
- plotter output, 3-49
- plotting, 3-32, 3-34
- PLT - - LOC - -, 3-49
- PLTS/PG 1 2 4, 3-49
- POINT, 1-38, 3-49
- point deletion, 3-36
- points
  - 3 dB, 3-15
  - 6 dB, 3-15
- polarity
  - EDGE POL POS NEG, 3-38
- power bandwidth, 3-16
- power input, 1-6
- POWER ON IP LAST, 3-49
- power-on state of spectrum analyzer, 3-49
- preamplifier gain, 3-39
- predetermined correction factors, 3-35



- prefix, catalog by, 3-27
- prefix, clear, 3-29
- prefix entry, 3-28
- prefix entry, external keyboard, 1-49
- prefix selection, 3-60
- preparing memory card for use, 1-23
- PRESEL DAC, 3-14, 3-50
- PRESEL DEFAULT, 2-9, 3-50
- preselector default, 3-50
- preselector peak, 2-9, 3-50
- PRESEL PEAK, 2-9, 3-50
- PRESET, 1-2, 3-50
- preset conditions
  - common, 3-51
  - model specific, 3-52
- PRESET SPECTRUM, 3-52
- preset spectrum conditions, 3-53
- print, black and white, 3-19
- PRINT CONFIG, 3-54
- PRINTER ADDRESS, 3-54
- printer and plotter configuration, 3-31
- printer, HP Paintjet, 3-32
- PRINTER SETUP, 3-54
- printing, 3-32, 3-34
  - HP PaintJet, 3-48
- print menu, 3-54
- PROBE PWR, 1-3
- program and variable cataloging, 3-22
- programming command entry, external keyboard, 1-49
- protect data, 1-20
- PRT MENU ON OFF, 3-54
- pulsed RF
  - using Option 105, 2-57
- pulse repetition interval, 2-57
- pulse width, 2-57
- PURGE AMP COR, 1-45, 3-54
- PURGE LIMITS, 1-34, 3-54
- PWR SWP ON OFF, 3-55

**Q**

- QP DET ON OFF, 3-14, 3-55
- QPD OFFSET, 3-14, 3-55
- QPD RST ON OFF, 3-14, 3-55
- QP GAIN ON OFF, 3-14, 3-55
- QP X10 ON OFF, 3-55
- QUASI PEAK, 3-56
- quasi-peak data, clear, 3-29
- quasi-peak detection
  - use with Option 105, 2-52
- quasi-peak marker amplitude value, 3-16
- quasi-peak measurement routine, 3-44
- quasi-peak normal marker, 3-45

**R**

- ratio, video bandwidth to resolution bandwidth, 3-67
- real-time clock, 3-64
  - set date, 3-60
  - set time, 3-60
  - time and date display, 3-64
- rear-panel features, 1-5-7
- RECALL, 1-3, 3-56
- RECALL AMP COR, 3-56
- recall DLP from memory card, 3-22
- recalling amplitude correction factors from analyzer memory, 1-20-21
- recalling amplitude correction factors from the memory card, 1-27-28
- recalling a program from the memory card, 1-29
- recalling a state from analyzer memory, 1-18-19
- recalling a state from the memory card, 1-25-26
- recalling a trace from analyzer memory, 1-19
- recalling a trace from the memory card, 1-26-27
- recalling limit lines from analyzer memory, 1-20-21
- recalling limit-line tables from the memory card, 1-27-28
- RECALL LIMIT, 3-56
- recall state from memory card, 3-22
- recall trace data, 3-42
- recall trace from memory card, 3-22
- reference detector
  - +10V, 3-15
  - 2V, 3-15
  - ground, 3-42
  - 10V, 3-15
- reference level, 3-56
- reference level offset, 3-57
- reflection calibration measurements, 2-50
- REF LVL, 3-56
- REF LVL OFFSET, 3-57
- remote commands, executing, 3-39
- remote operation, 3-31
- RES BW AUTO MAN, 3-57
- resolution bandwidth, 3-57
  - resolving signals, 2-2-5
- resolution of marker counter, 3-31
- RETURN, 3-57
- return loss, measuring, 2-51
- RF OUT 50 $\Omega$ , 1-4
- RF OUT 75 $\Omega$ , 1-4
- RPG knob, 1-7
- RPG TITLE, 3-57
- RS-232 interface connector, 1-6

TV SYNC NEG POS, 3-66

TV trig

even field, 3-66

NTSC video format, 3-48

odd field, 3-66

PAL-M video format, 3-48

PAL video format, 3-48

SECAM-L video format, 3-59

TV line number, 3-66

TVSTND, 3-66

TV sync, 3-66

vertical interval, 3-66

TV TRIG, 2-48, 3-66

TV TRIG EVEN FLD, 2-48, 3-66

TV triggering, 2-48

TV TRIG ODD FLD, 3-66

TV TRIG OUTPUT, 1-5

TV TRIG VERT INT, 3-66

type of limit line, 3-60

## U

underscore, 3-68

unleveled condition, tracking generator, 2-45

upper and lower limit lines, 1-35, 1-39

upper and lower limit lines, editing, 3-39

upper limit line, 1-35

user-created error messages, A-1

USER MENU(S), 3-66

using amplitude-correction functions, 1-41

using limit-line functions, 1-31-41

using the GATE CTL EDGE LVL, 2-56

using the level gate control, 2-57

using the self-calibration routines with Option  
105, 2-54

## V

VBW/RBW RATIO, 3-67

VERIFY TIMEBASE, 3-67

vertical signal positioning, 3-34

VID AVG ON OFF, 3-67

VID BW AUTO MAN, 3-67

VIDEO, 3-67

video averaging, 2-21, 3-67

video bandwidth, 3-67

video bandwidth to resolution bandwidth ratio,  
3-67

video picture field, triggering on a selected line,  
2-48

VIEW A, 3-67

VIEW B, 3-68

VIEW C, 3-68

VOL-INTEN, 1-3

VOLTAGE SELECTOR, 1-6

Volts, 3-68

volume control, 1-3

## W

warm-up time, 1-15

Watts, 3-68

when self-calibration is needed, 1-17

## X

X FINE TUNE DAC, 3-14, 3-68

## Y

YTF DRIVER, 3-14, 3-68

YTF self-calibration routine, 1-17

YTF slope and offset adjustment, 3-22

YTF TUNE COARSE, 3-14, 3-68

YTF TUNE FINE, 3-14, 3-68

YZ-# SPC CLEAR, 3-68

## Z

ZERO SPAN, 2-8, 3-68

# Artisan Technology Group is an independent supplier of quality pre-owned equipment

## Gold-standard solutions

Extend the life of your critical industrial, commercial, and military systems with our superior service and support.

## We buy equipment

Planning to upgrade your current equipment? Have surplus equipment taking up shelf space? We'll give it a new home.

## Learn more!

Visit us at [artisanng.com](http://artisanng.com) for more info on price quotes, drivers, technical specifications, manuals, and documentation.

Artisan Scientific Corporation dba Artisan Technology Group is not an affiliate, representative, or authorized distributor for any manufacturer listed herein.

We're here to make your life easier. How can we help you today?

(217) 352-9330 | [sales@artisanng.com](mailto:sales@artisanng.com) | [artisanng.com](http://artisanng.com)

